

TECHNICAL SHEET

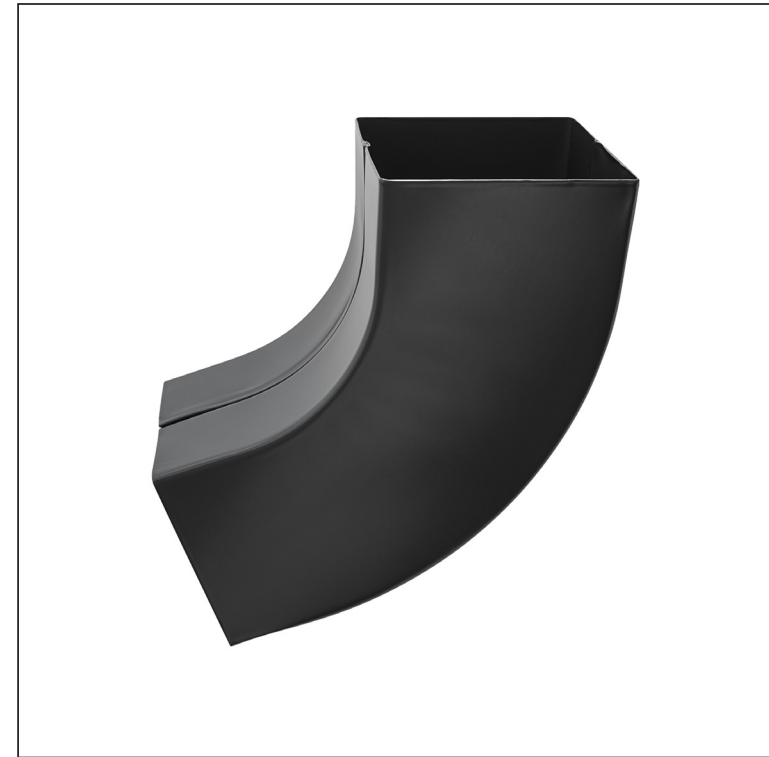

# ELBOW SQUARE 72°

# PH-PKH

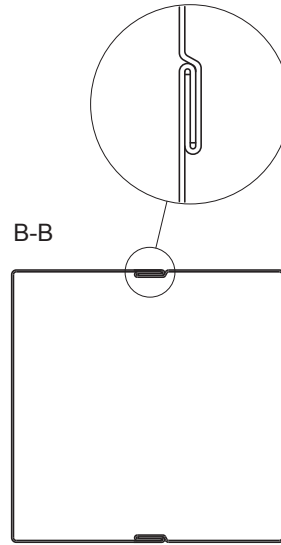

**IC** Galvanized steel prepainted – Intense black – RAL 9005

Dimensions [mm]			
Nominal size	AxA	A1xA1	L
80/80	78 x 78	83 x 83	210
100/100	98 x 98	103 x 103	270

INDEX	CHANGE	DATE	SIGNATURE		
MATERIAL BRAND			W.C.	WEIGHT kg	SCALE
SIZE, SEMI-FINISHED PRODUCTS				STN STANDARD	SORTING NUMBER
AUXILIARY EQUIPMENT				NOTE	POSITION NUMBER
ELABORATED BY Ing. Kluska M.				OLD DRAWING	DRAWING NUMBER
TESTED BY					
TECHNOLOGIST		TECHNOLOGIST		Number of sheets	PH-PKH Sheet 
NAME			Elbow square 72°		

Created: 20.04.2026 16:41:44

Technical changes reserved

TECHNICAL SHEET

# ELBOW SQUARE 72°

# PH-PKH

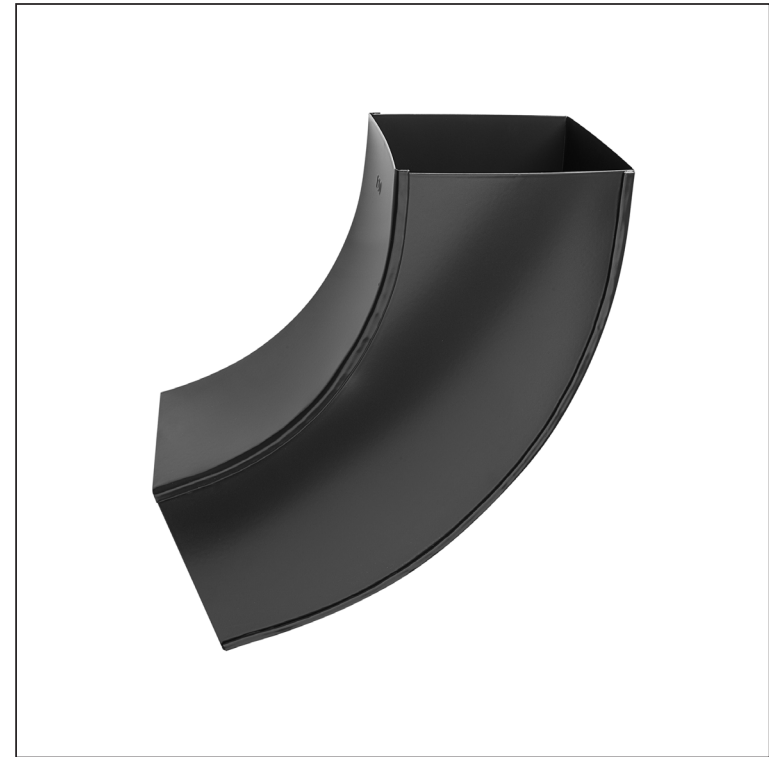
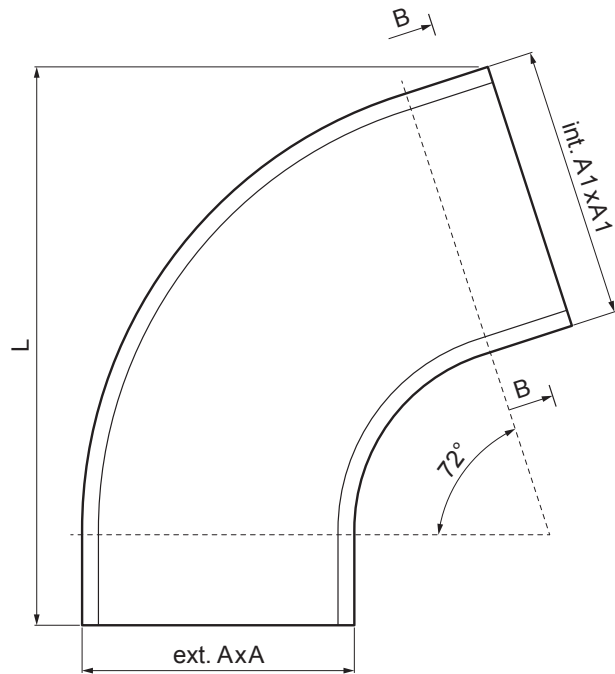

**IC** Galvanized steel prepainted – Intense black – RAL 9005

INDEX	CHANGE	DATE	SIGNATURE	<b>KJG</b> QUALITY®	Scan code for 3D model
MATERIAL BRAND			W.C.	WEIGHT kg	SCALE
SIZE, SEMI-FINISHED PRODUCTS				STN STANDARD	SORTING NUMBER
AUXILIARY EQUIPMENT				NOTE	POSITION NUMBER
ELABORATED BY Ing. Kluska M.				OLD DRAWING	DRAWING NUMBER
TESTED BY					
TECHNOLOGIST			TECHNOLOGIST		
NAME			Elbow square 72°		
			Number of sheets	PH-PKH	Sheet

Created: 20.04.2026 16:41:44

Technical changes reserved

Dimensions [mm]			
Nominal size	AxA	A1xA1	L
120/120	118 x 118	123 x 123	300
150/150	148 x 148	153 x 153	350