

TECHNICAL SHEET

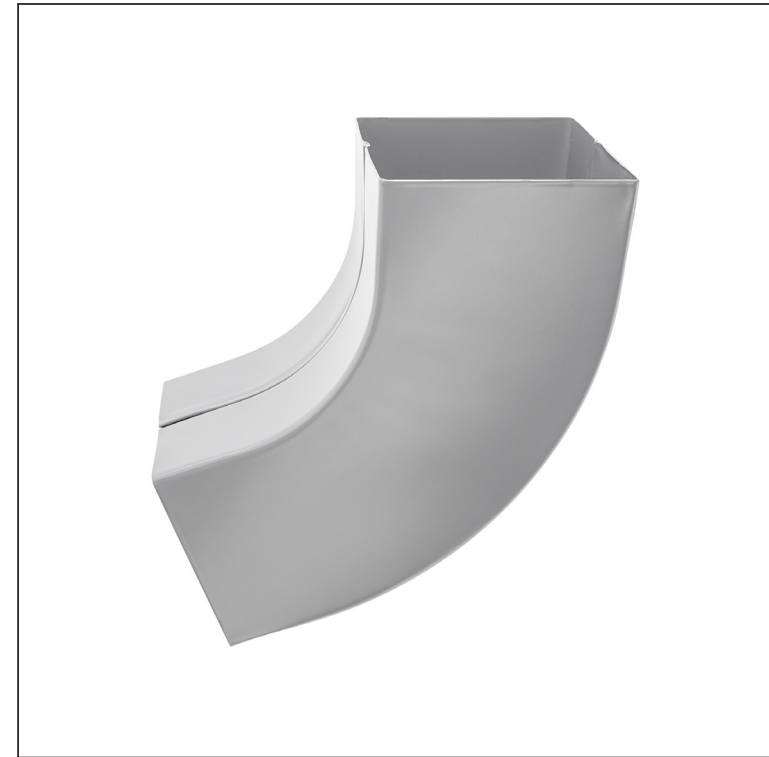

ELBOW SQUARE 72°

PH-PKH

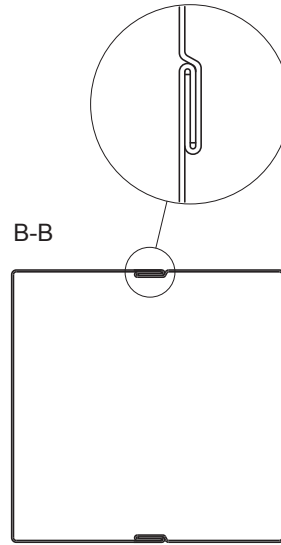

BH Galvanized steel pre-painted – White aluminum – RAL 9006

Dimensions [mm]			
Nominal size	AxA	A1xA1	L
80/80	78 x 78	83 x 83	210
100/100	98 x 98	103 x 103	270

INDEX	CHANGE	DATE	SIGNATURE		
MATERIAL BRAND			W.C.	WEIGHT kg	SCALE
SIZE, SEMI-FINISHED PRODUCTS				STN STANDARD	SORTING NUMBER
AUXILIARY EQUIPMENT				NOTE	POSITION NUMBER
ELABORATED BY Ing. Kluska M.					
TESTED BY					
TECHNOLOGIST		TECHNOLOGIST		OLD DRAWING	DRAWING NUMBER
NAME				Number of sheets	PH-PKH Sheet 
Elbow square 72°					

Created: 22.04.2026 10:58:34

Technical changes reserved



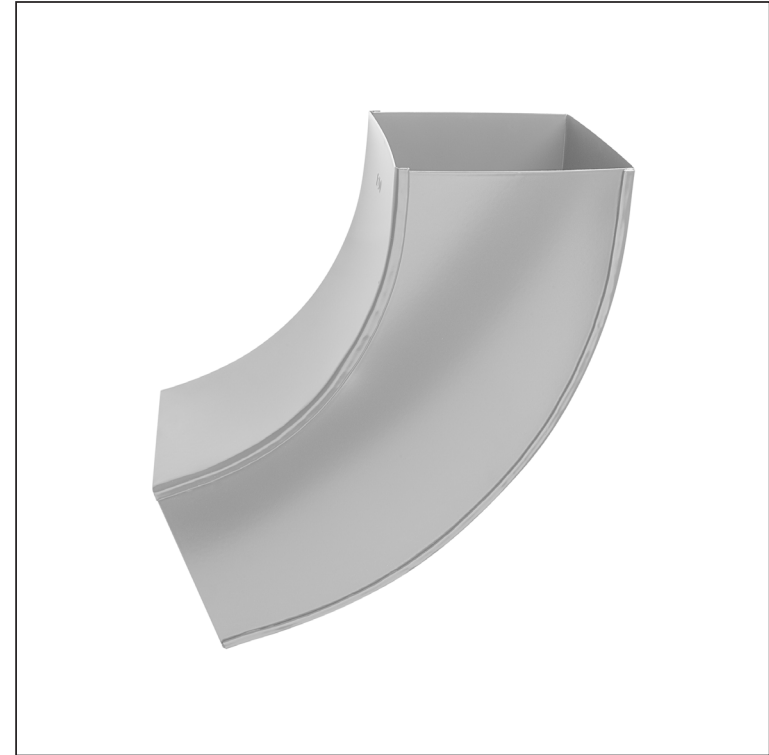

TECHNICAL SHEET

ELBOW SQUARE 72°

PH-PKH



BH Galvanized steel pre-painted – White aluminum – RAL 9006

INDEX	CHANGE	DATE	SIGNATURE			
MATERIAL BRAND			W.C.	WEIGHT kg	SCALE	
SIZE, SEMI-FINISHED PRODUCTS				STN STANDARD	SORTING NUMBER	
AUXILIARY EQUIPMENT				NOTE	POSITION NUMBER	
ELABORATED BY Ing. Kluska M.				OLD DRAWING	DRAWING NUMBER	
TESTED BY						
TECHNOLOGIST			TECHNOLOGIST			
NAME			Elbow square 72°		Number of sheets	PH-PKH Sheet 

Created: 22.04.2026 10:58:34

Technical changes reserved

Dimensions [mm]			
Nominal size	AxA	A1xA1	L
120/120	118 x 118	123 x 123	300
150/150	148 x 148	153 x 153	350