

TECHNICAL SHEET

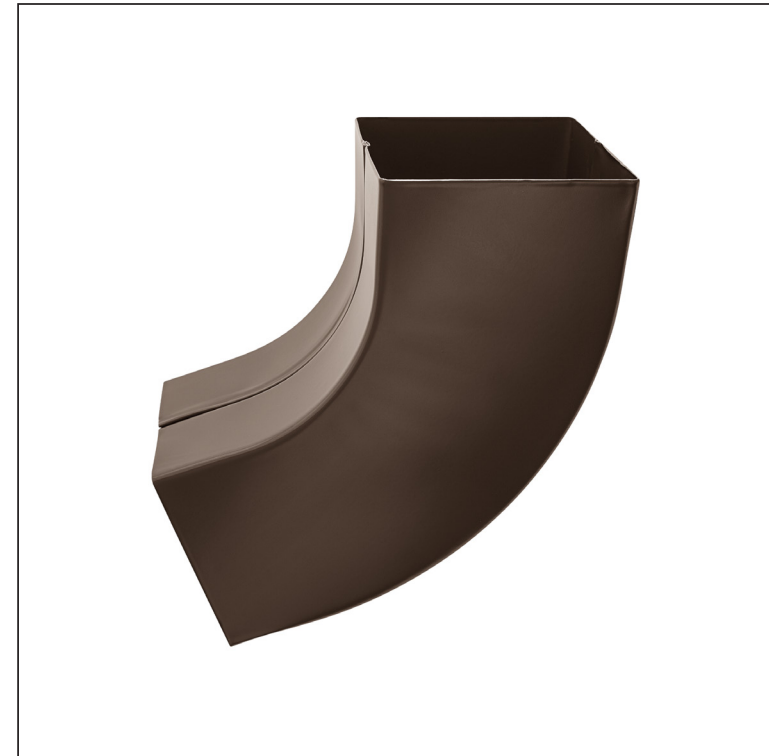

ELBOW SQUARE 72°

WH-WKH

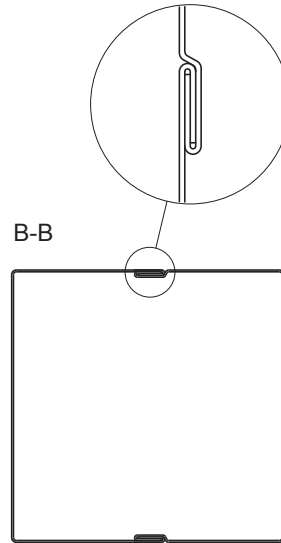
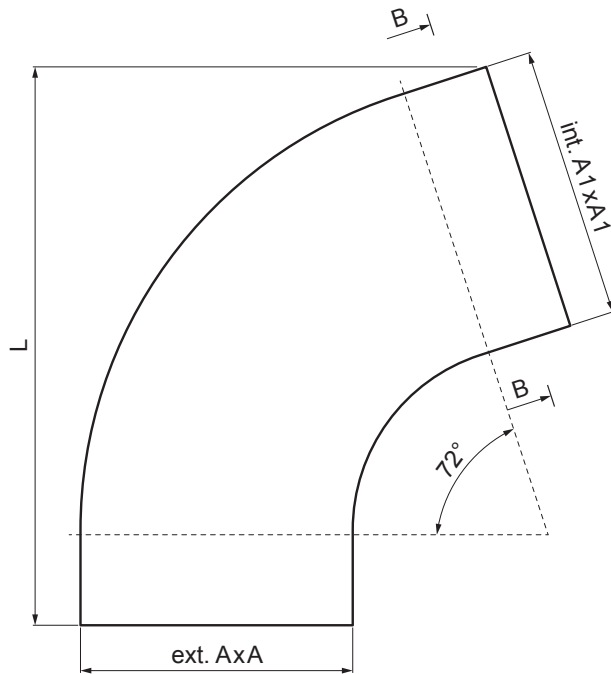

TM Aluminium pre-painted – Testa di Moro – RAL 8028

Dimensions [mm]			
Nominal size	AxA	A1xA1	L
80/80	78 x 78	83 x 83	210
100/100	98 x 98	103 x 103	270

INDEX	CHANGE	DATE	SIGNATURE		
MATERIAL BRAND			W.C.	WEIGHT kg	SCALE
SIZE, SEMI-FINISHED PRODUCTS					
AUXILIARY EQUIPMENT				STN STANDARD	SORTING NUMBER
ELABORATED BY Ing. Kluska M.				NOTE	POSITION NUMBER
TESTED BY					
TECHNOLOGIST		TECHNOLOGIST		OLD DRAWING	DRAWING NUMBER
NAME				WH-WKH	
Elbow square 72°				Number of sheets	Sheet 

Created: 06.06.2026 19:51:22

Technical changes reserved



TECHNICAL SHEET

ELBOW SQUARE 72°

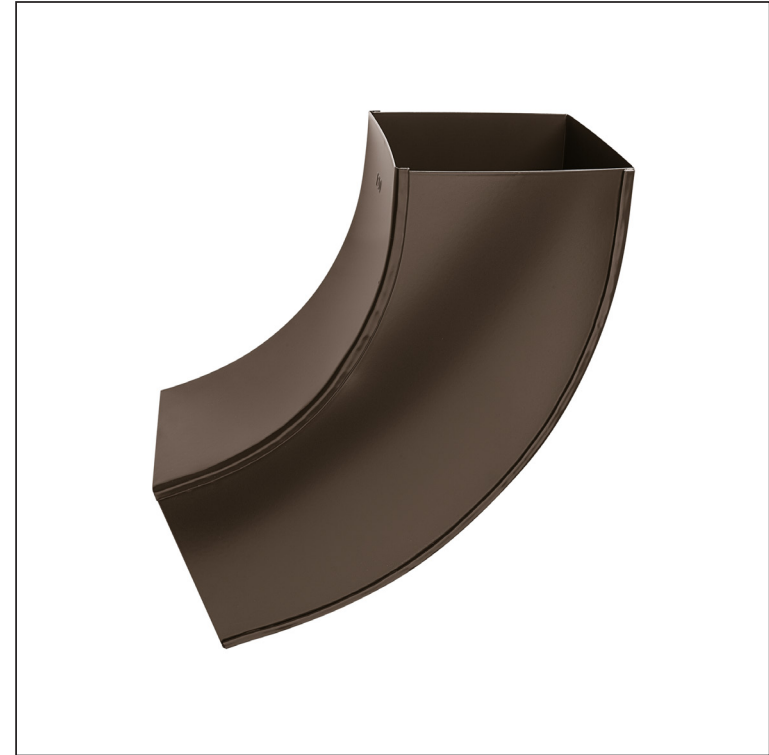
WH-WKH



TM Aluminium pre-painted – Testa di Moro – RAL 8028

INDEX	CHANGE	DATE	SIGNATURE		
MATERIAL BRAND			W.C.	WEIGHT kg	SCALE
SIZE, SEMI-FINISHED PRODUCTS				STN STANDARD	SORTING NUMBER
AUXILIARY EQUIPMENT				NOTE	POSITION NUMBER
ELABORATED BY Ing. Kluska M.				OLD DRAWING	DRAWING NUMBER
TESTED BY					
TECHNOLOGIST		TECHNOLOGIST		Number of sheets	WH-WKH Sheet 
NAME			Elbow square 72°		

Created: 06.06.2026 19:51:22

Technical changes reserved

Dimensions [mm]			
Nominal size	AxA	A1xA1	L
120/120	118 x 118	123 x 123	300