

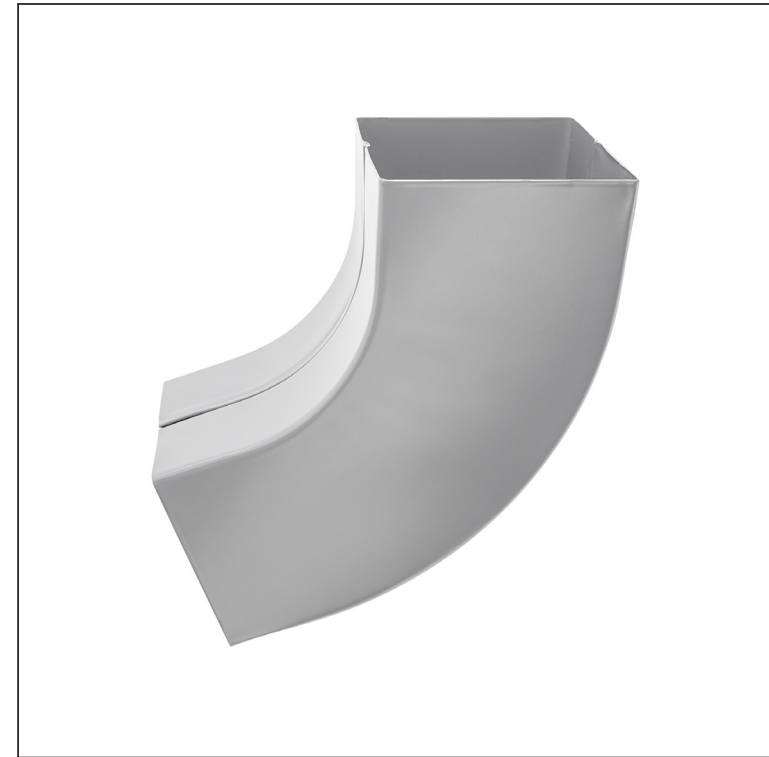

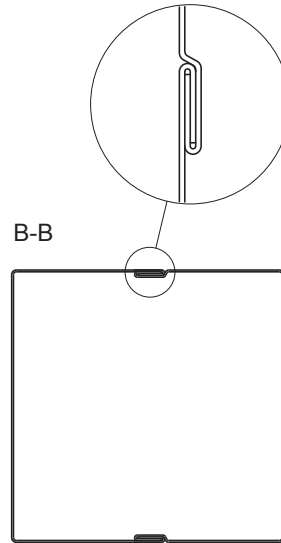

TECHNICAL SHEET

ELBOW SQUARE 72°

WH-WKH



BH Aluminium pre-painted – White aluminum – RAL 9006

INDEX	CHANGE	DATE	SIGNATURE		
MATERIAL BRAND			W.C.	WEIGHT kg	SCALE
SIZE, SEMI-FINISHED PRODUCTS				STN STANDARD	SORTING NUMBER
AUXILIARY EQUIPMENT				NOTE	POSITION NUMBER
ELABORATED BY Ing. Kluska M.				OLD DRAWING	DRAWING NUMBER
TESTED BY					
TECHNOLOGIST			TECHNOLOGIST		
NAME			Elbow square 72°		Number of sheets
					WH-WKH Sheet 

Created: 07.06.2026 12:06:53

Technical changes reserved

Dimensions [mm]			
Nominal size	AxA	A1xA1	L
80/80	78 x 78	83 x 83	210
100/100	98 x 98	103 x 103	270



TECHNICAL SHEET

ELBOW SQUARE 72°

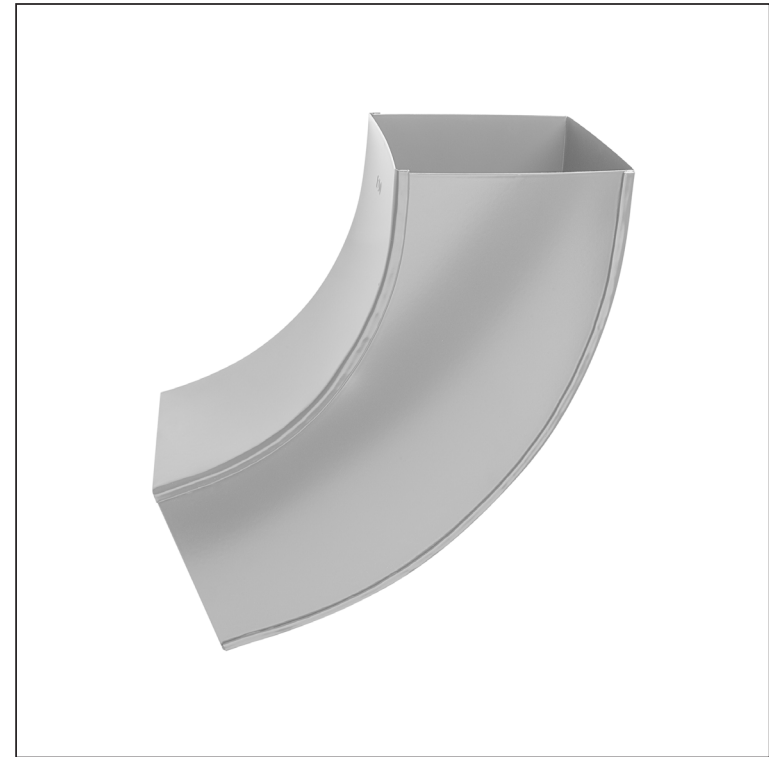
WH-WKH



BH Aluminium pre-painted – White aluminum – RAL 9006

INDEX	CHANGE	DATE	SIGNATURE		
MATERIAL BRAND			W.C.	WEIGHT kg	SCALE
SIZE, SEMI-FINISHED PRODUCTS				STN STANDARD	SORTING NUMBER
AUXILIARY EQUIPMENT				NOTE	POSITION NUMBER
ELABORATED BY Ing. Kluska M.				OLD DRAWING	DRAWING NUMBER
TESTED BY					
TECHNOLOGIST			TECHNOLOGIST		
NAME			Elbow square 72°		Number of sheets
					WH-WKH Sheet 

Created: 07.06.2026 12:06:53

Technical changes reserved

Dimensions [mm]			
Nominal size	AxA	A1xA1	L
120/120	118 x 118	123 x 123	300