

TECHNICAL SHEET

RIDGE CAP FOR METAL ROOFING

UNI-HRE

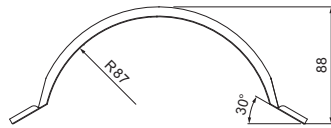
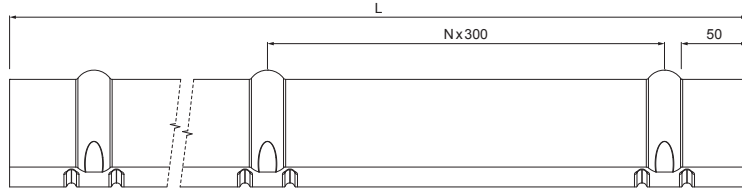

DETAIL:

- 1. ridge cap for metal roofing 2 m or 3 m covering width 1,864 m (2m) and 2,936 m (3m)
- 2. farmer screw 4,8x20
- 3. metal roofing
- 4. roof battens
- 5. battens
- 6. rafter
- 7. drip edge
- 8. protective ventilation belt
- 9. foil
- 10. gutter half-round
- 11. hook

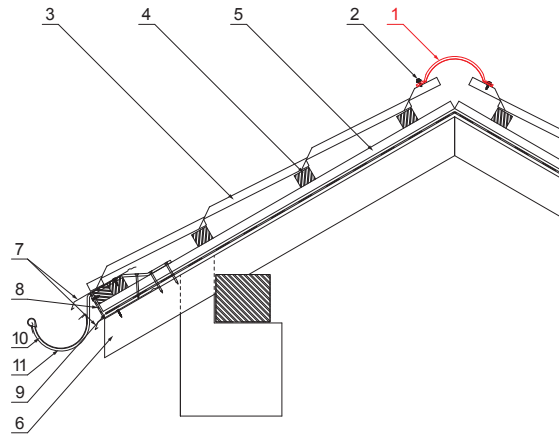

B Galvanized steel pre-painted – Pure white – RAL 9010

INDEX	CHANGE	DATE	SIGNATURE		
MATERIAL BRAND			W.C.	WEIGHT kg	SCALE
SIZE, SEMI-FINISHED PRODUCTS				STN STANDARD	SORTING NUMBER
AUXILIARY EQUIPMENT				NOTE	POSITION NUMBER
ELABORATED BY Ing. Kluska M.					
TESTED BY		TECHNOLOGIST		OLD DRAWING	DRAWING NUMBER
NAME				UNI-HRE	
Ridge cap for metal roofing				Number of sheets	Sheet

Created: 20.04.2026 08:38:15

Technical changes reserved

Dimensions [mm]		
Length [m]	L	N
2,0	1925	6