

TECHNICAL SHEET

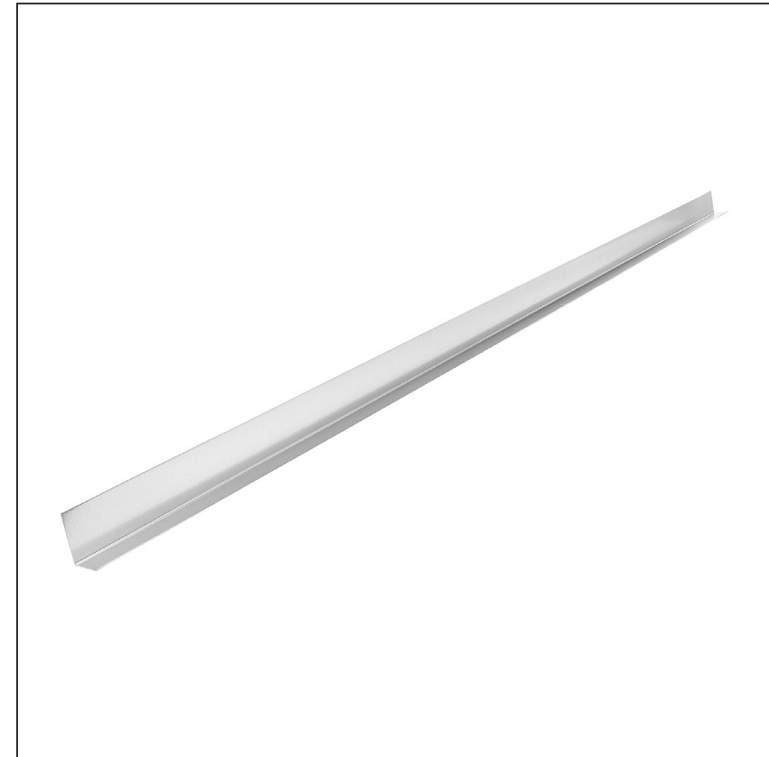

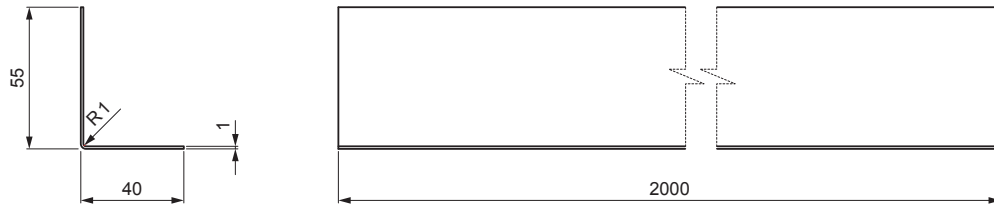

# GALVANIZED REINFORCEMENT OF SNOW STOPPER

# UNI-ZS VYSTUZ

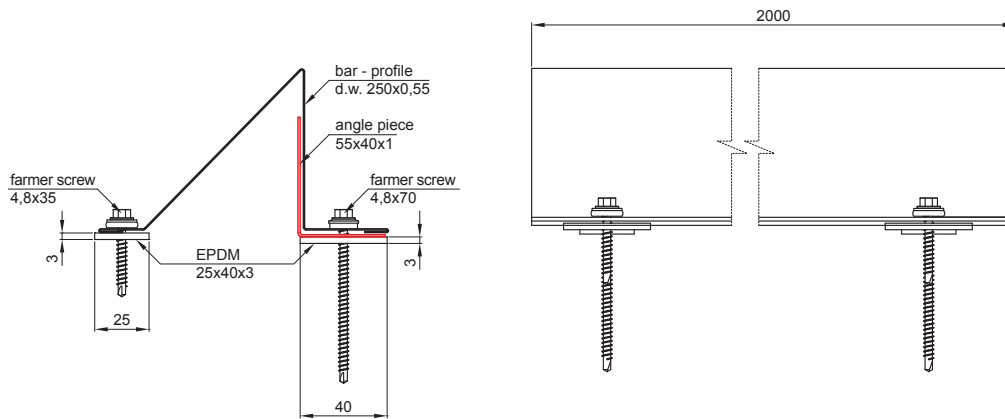

**P** Galvanized steel – Natur



INDEX	CHANGE	DATE	SIGNATURE			
MATERIAL BRAND			W.C.	WEIGHT kg	SCALE	
SIZE, SEMI-FINISHED PRODUCTS				STN STANDARD	SORTING NUMBER	
AUXILIARY EQUIPMENT				NOTE	POSITION NUMBER	
ELABORATED BY Ing. Kluska M.						
TESTED BY						
TECHNOLOGIST		TECHNOLOGIST		OLD DRAWING	DRAWING NUMBER	
NAME galvanized reinforcement of snow stopper				Number of sheets	UNI-ZS VYSTUZ Sheet 	

Created: 04.06.2026 03:20:07

Technical changes reserved