

TECHNICAL SHEET

RIDGE CAP FOR METAL ROOFING

W-UNI HRE

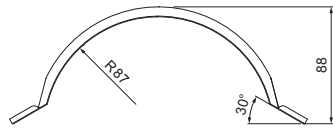

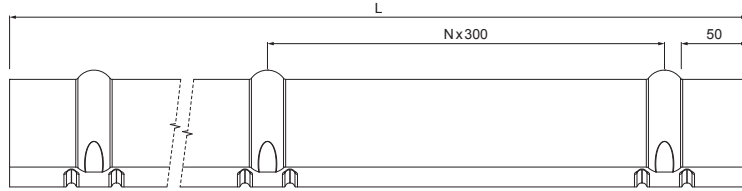

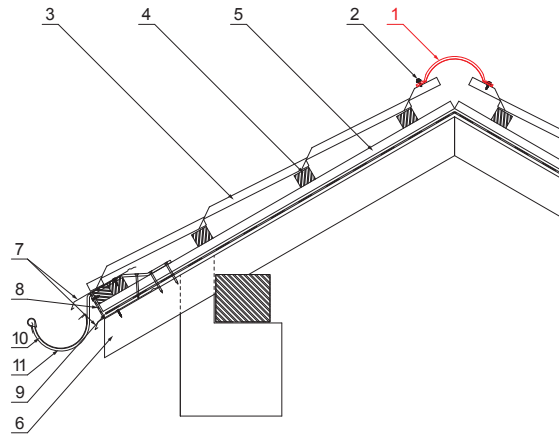

DETAIL:

- 1. ridge cap for metal roofing 2 m or 3 m covering width 1,864 m (2 m) and 2,936 m (3 m)
- 2. farmer screw 4,8x20
- 3. metal roofing
- 4. roof battens
- 5. battens
- 6. rafter
- 7. drip edge
- 8. protective ventilation belt
- 9. foil
- 10. gutter half-round
- 11. hook



B Aluminium pre-painted – Pure white – RAL 9010

INDEX	CHANGE	DATE	SIGNATURE			
MATERIAL BRAND			W.C.	WEIGHT kg	SCALE	
SIZE, SEMI-FINISHED PRODUCTS					STN STANDARD	
AUXILIARY EQUIPMENT					SORTING NUMBER	
ELABORATED BY Ing. Kluska M.					NOTE	
TESTED BY					POSITION NUMBER	
TECHNOLOGIST		TECHNOLOGIST		OLD DRAWING	DRAWING NUMBER	
NAME				Ridge cap for metal roofing		
				Number of sheets	W-UNI HRE	
					Sheet	

Created: 21.04.2026 04:45:30

Technical changes reserved

Dimensions [mm]		
Length [m]	L	N
2,0	1925	6