

TECHNICAL SHEET

PROFILE FILLER STRIP GRAY FOR TRAPEZOIDAL SHEET TR 18

TR-18 UTP

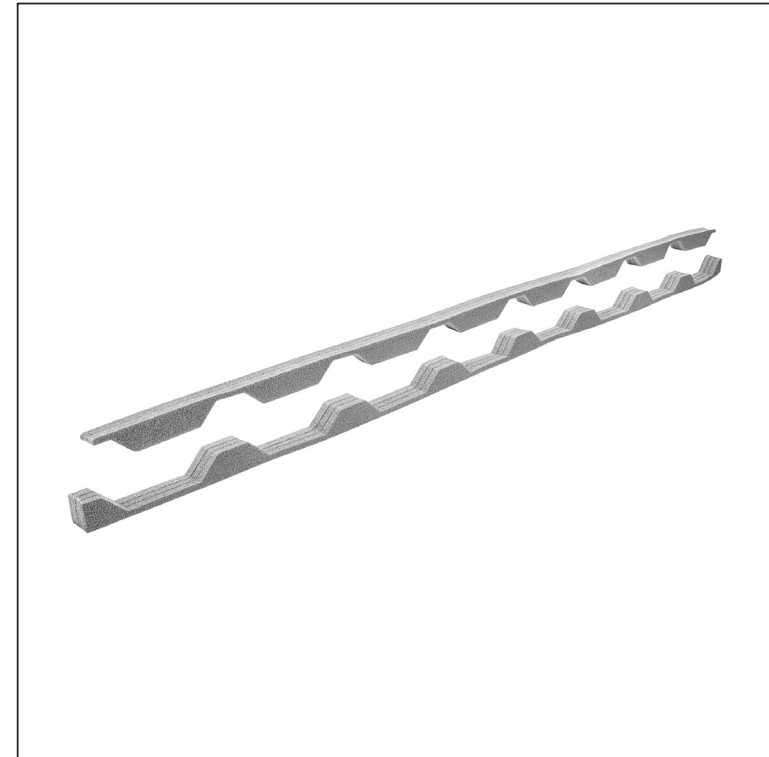

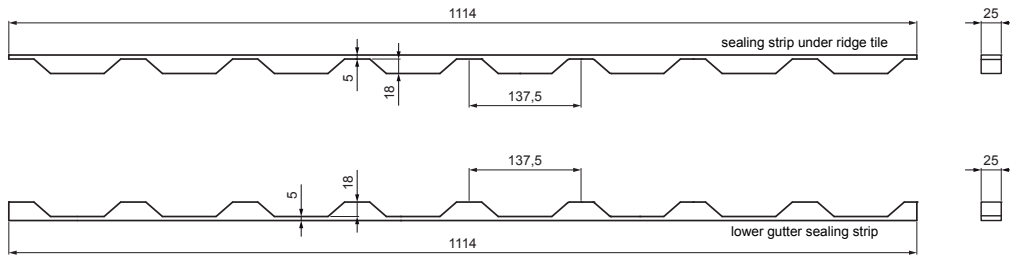

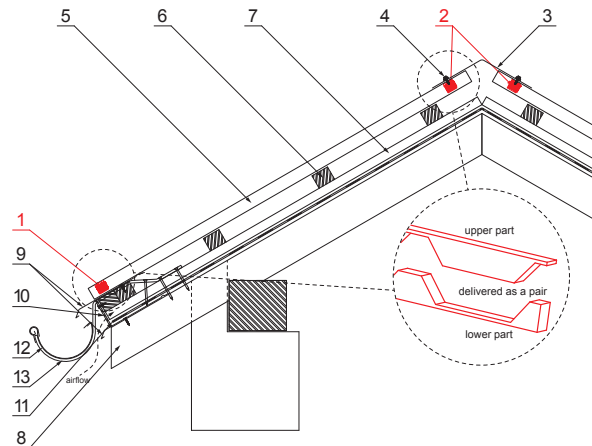

DETAIL:

- 1. gutter sealing strip
- 2. sealing strip under ridge tile
- 3. ridge cap
- 4. farmer screw 4,8x20
- 5. trapezoidal sheet
- 6. roof battens
- 7. battens
- 8. rafter
- 9. drip edge
- 10. protective ventilation belt
- 11. foil
- 12. gutter half-round
- 13. hook



PS Polyethylene – Dusty grey – RAL 7037

INDEX	CHANGE	DATE	SIGNATURE			
MATERIAL BRAND			W.C.	WEIGHT kg	SCALE	
SIZE, SEMI-FINISHED PRODUCTS				STN STANDARD	SORTING NUMBER	
AUXILIARY EQUIPMENT				NOTE	POSITION NUMBER	
ELABORATED BY Ing. Kluska M.						
TESTED BY				OLD DRAWING	DRAWING NUMBER	
TECHNOLOGIST			TECHNOLOGIST			
NAME				Number of sheets		TR-18 UTP
Profile filler strip gray for trapezoidal sheet TR 18						Sheet 

Created: 05.06.2026 18:58:29

Technical changes reserved