

TECHNICAL SHEET

ALUMINUM CALOTTE WASHER TR 35

TR-ORK TR35

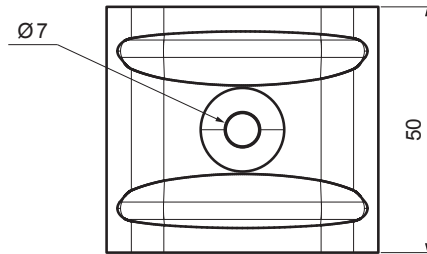
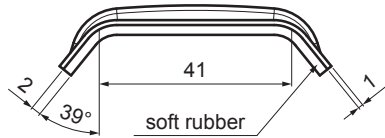

VALUES FOR DETERMINING THE CORRECT CALLOTE:

- width of upper wave (mm)
- angle α (°)
- or**
- width of upper wave (mm)
- profile height (mm)
- clear width of upper wave (mm)

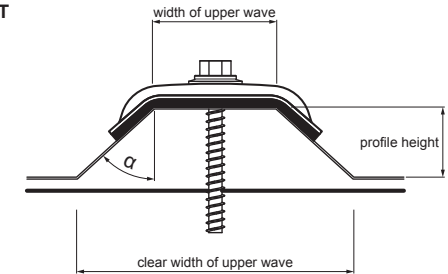

USE:
- to fix TR in its upper wave

FEATURES:
- increases stability
- security of attachment

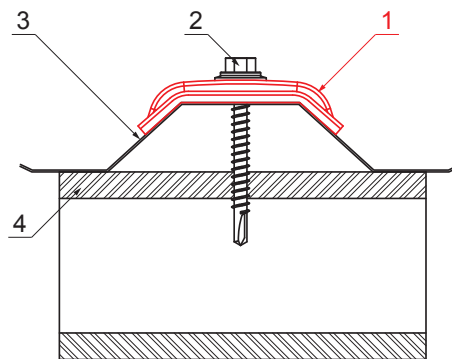
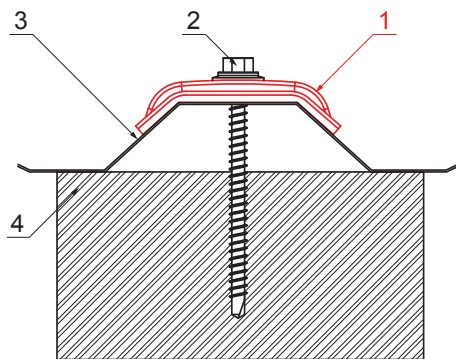

DETAIL:
1. aluminum calotte washer TR
2. galvanized TR screw for wood
3. trapezoidal sheet roof
4. wood

DETAIL:
1. aluminum calotte washer TR
2. galvanized TR screw for steel
3. trapezoidal sheet roof
4. steel

BH Aluminium preprinted – White aluminium – RAL 9006

INDEX	CHANGE	DATE	SIGNATURE	KJG QUALITY	Scan code for 3D model	
MATERIAL BRAND			W.C.	WEIGHT kg	SCALE	
SIZE, SEMI-FINISHED PRODUCTS				STN STANDARD	SORTING NUMBER	
AUXILIARY EQUIPMENT				NOTE	POSITION NUMBER	
ELABORATED BY Ing. Kluska M.						
TESTED BY				OLD DRAWING	DRAWING NUMBER	
TECHNOLOGIST			TECHNOLOGIST			
NAME			Aluminum calotte washer TR 35		TR-ORK TR35	
			Number of sheets		Sheet	

Created: 20.04.2026 16:09:48

Technical changes reserved