

TECHNICAL SHEET

ICE BREAKER FOR SNOW STOPPER FOR FALZ

ZS-WZSF ROLA

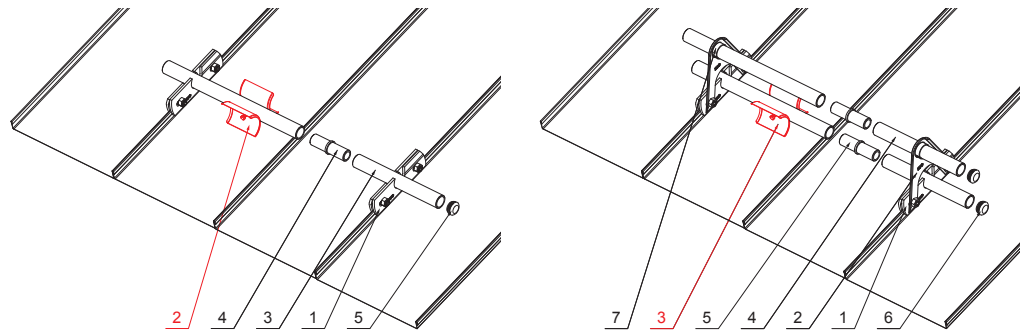
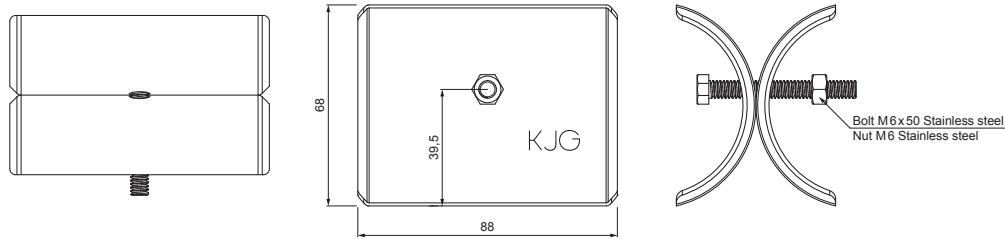

DETAIL:













1. snow stopper clamp for falz
2. ice breaker for snow stopper for falz
3. pipe for snow stopper
4. PVC pipe coupling for snow stopper
5. PVC pipe end cap for snow stopper

DETAIL:

1. snow stopper clamp for falz
2. extension for snow stopper pipe holder for falz
3. ice breaker for snow stopper for falz
4. pipe for snow stopper
5. PVC pipe coupling for snow stopper
6. PVC pipe end cap for snow stopper
7. PVC spacer ring for snow stopper



AN Aluminium pre-painted – Anthracite – RAL 7016

INDEX CHANGE	DATE	SIGNATURE	W.C.	WEIGHT kg	SCALE			
MATERIAL BRAND				STN STANDARD				
SIZE, SEMI-FINISHED PRODUCTS				NOTE				
AUXILIARY EQUIPMENT				OLD DRAWING				
ELABORATED BY Ing. Kluska M.				DRAWING NUMBER				
TESTED BY				DRAWING NUMBER				
TECHNOLOGIST				DRAWING NUMBER				
NAME				Ice breaker for snow stopper for falz				
Number of sheets				ZS-WZSF ROLA				
				Sheet				

Created: 21.04.2026 20:27:41

Technical changes reserved