

TECHNICAL SHEET

ICE BREAKER FOR SNOW STOPPER FOR FALZ

ZS-WZSF ROLA

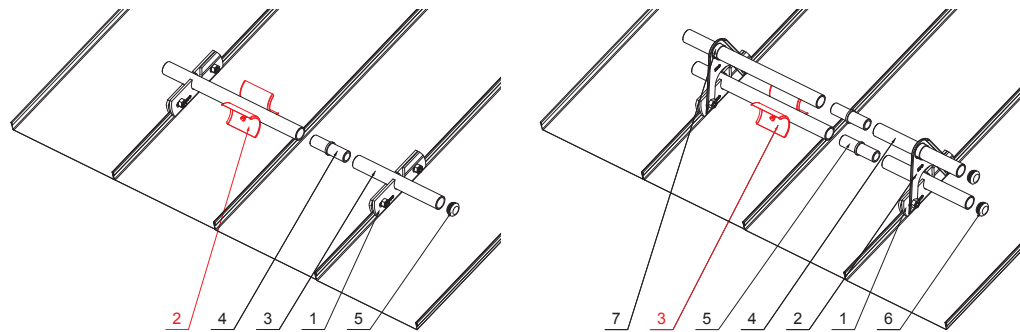
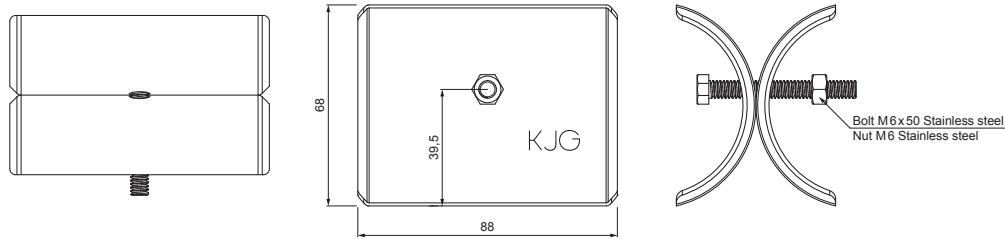

DETAIL:



1. snow stopper clamp for falz
2. ice breaker for snow stopper for falz
3. pipe for snow stopper
4. PVC pipe coupling for snow stopper
5. PVC pipe end cap for snow stopper

DETAIL:

1. snow stopper clamp for falz
2. extension for snow stopper pipe holder for falz
3. ice breaker for snow stopper for falz
4. pipe for snow stopper
5. PVC pipe coupling for snow stopper
6. PVC pipe end cap for snow stopper
7. PVC spacer ring for snow stopper



ZH Aluminium pre-painted – Brown grey – RAL 7013

INDEX CHANGE	DATE	SIGNATURE	W.C.	WEIGHT kg	SCALE			
MATERIAL BRAND				SIZE, SEMI-FINISHED PRODUCTS		STN STANDARD		SORTING NUMBER
AUXILIARY EQUIPMENT				ELABORATED BY Ing. Kluska M.		NOTE		POSITION NUMBER
TESTED BY				TECHNOLOGIST		OLD DRAWING		DRAWING NUMBER
NAME				Ice breaker for snow stopper for falz		Number of sheets		ZS-WZSF ROLA Sheet

Created: 04.06.2026 16:46:46

Technical changes reserved