

TECHNICAL SHEET

# ICE BREAKER FOR SNOW STOPPER FOR FALZ ZS-W.15ZSF ROLA

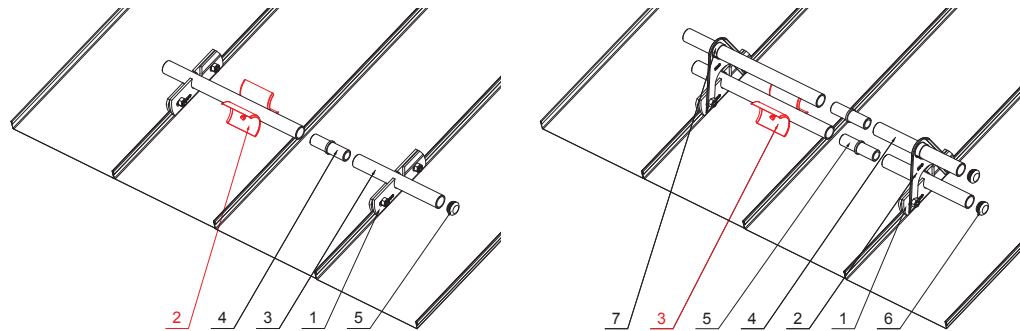

**DETAIL:**

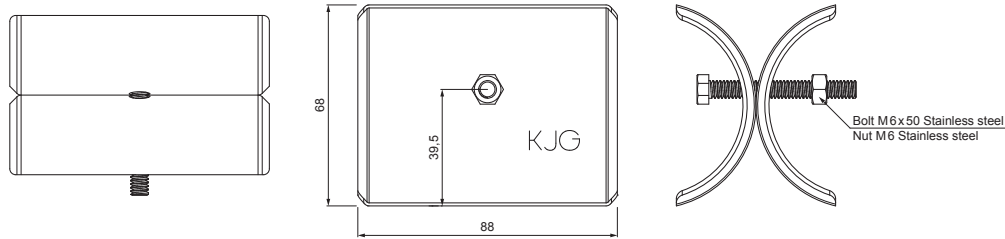









1. snow stopper clamp for falz
2. ice breaker for snow stopper for falz
3. pipe for snow stopper
4. PVC pipe coupling for snow stopper
5. PVC pipe end cap for snow stopper

**DETAIL:**

1. snow stopper clamp for falz
2. extension for snow stopper pipe holder for falz
3. ice breaker for snow stopper for falz
4. pipe for snow stopper
5. PVC pipe coupling for snow stopper
6. PVC pipe end cap for snow stopper
7. PVC spacer ring for snow stopper



**ANM** Aluminium pre-painted W.15 – Anthracite W.15 – RAL 7016

INDEX CHANGE	DATE	SIGNATURE	W.C.	WEIGHT kg	SCALE			
MATERIAL BRAND				STN STANDARD				
SIZE, SEMI-FINISHED PRODUCTS				NOTE				
AUXILIARY EQUIPMENT				DRAWING NUMBER				
ELABORATED BY Ing. Kluska M.				OLD DRAWING				
TESTED BY				DRAWING NUMBER				
TECHNOLOGIST				NUMBER OF SHEETS				
NAME				ZS-W.15ZSF ROLA				
Ice breaker for snow stopper for falz				Number of sheets				

Created: 20.04.2026 07:40:46

Technical changes reserved