

TECHNICAL SHEET

ROOF COVERING RIDGE CAPPING

KRS-MKRSH

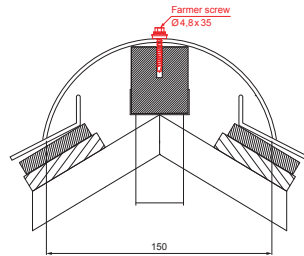

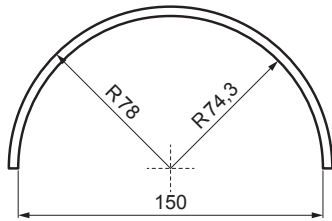
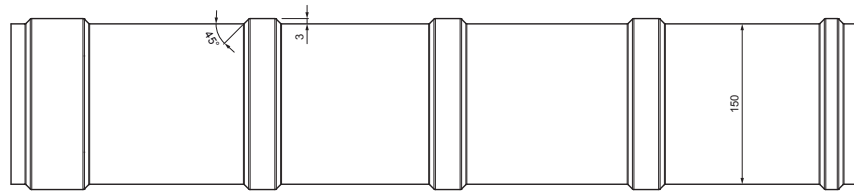
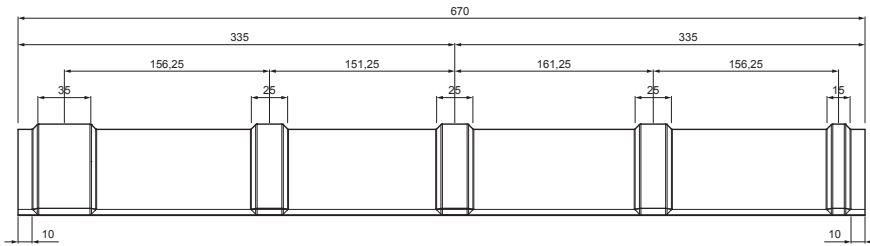

M Copper – Natur

DETAIL:

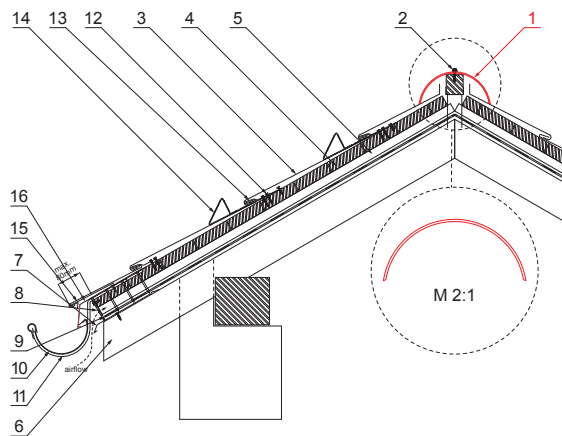
1. roof covering ridge capping
2. farmer screw 4,8x35
3. roof covering KJG rhomboid roof tile
4. roof battens
5. batten
6. rafter
7. drip edge
8. protective ventilation belt
9. foil
10. gutter half-round
11. hook
12. screw with TORX head for clip
13. clip for rhomboid roof tile stainless steel
14. nose snow stopper for rhomboid roof tile
15. base strip
16. cover sheet



INDEX	CHANGE	DATE	SIGNATURE	 	
MATERIAL BRAND			W.C.	WEIGHT kg	SCALE
SIZE, SEMI-FINISHED PRODUCTS					
AUXILIARY EQUIPMENT			STN STANDARD		SORTING NUMBER
ELABORATED BY Ing. Kluska M.			NOTE		POSITION NUMBER
TESTED BY					
TECHNOLOGIST		TECHNOLOGIST	OLD DRAWING		DRAWING NUMBER
NAME			Roof covering ridge capping		
			Number of sheets		KRS-MKRSH
					Sheet 

Created: 05.06.2026 23:43:36

Technical changes reserved