

TECHNICAL SHEET

# ROOF COVERING RIDGE CAPPING

# KRS-PKRSH

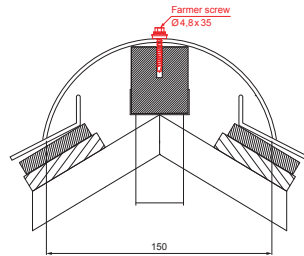

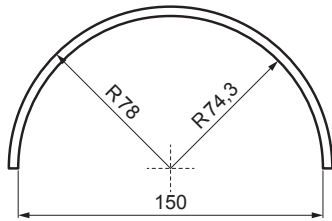
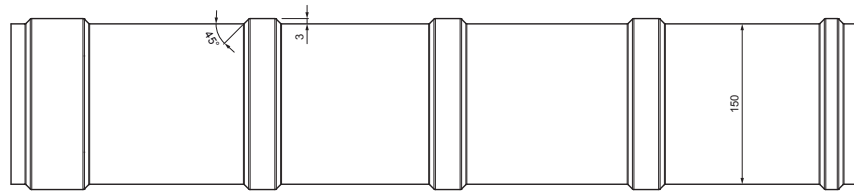
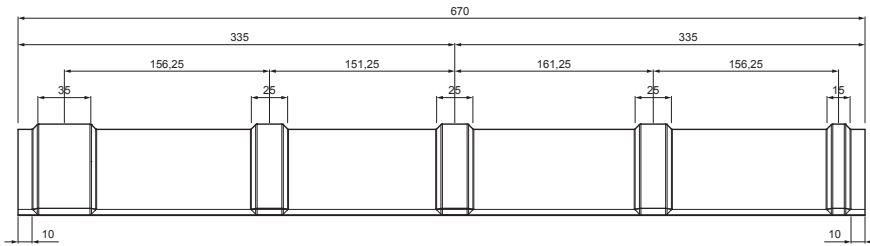

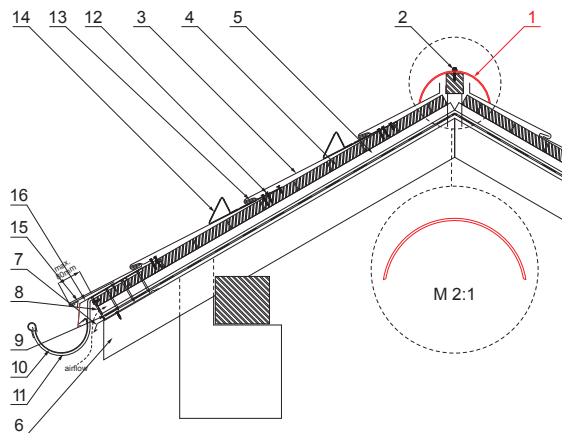

**DETAIL:**

1. roof covering ridge capping
2. farmer screw 4,8x35
3. roof covering KJG rhomboid roof tile
4. roof battens
5. batten
6. rafter
7. drip edge
8. protective ventilation belt
9. foil
10. gutter half-round
11. hook
12. screw with TORX head for clip
13. clip for rhomboid roof tile stainless steel
14. nose snow stopper for rhomboid roof tile
15. base strip
16. cover sheet



**AN** Galvanized steel prepainted – Anthracite – RAL 7016

INDEX	CHANGE	DATE	SIGNATURE	  	
MATERIAL BRAND			W.C.	WEIGHT kg	SCALE
SIZE, SEMI-FINISHED PRODUCTS					
AUXILIARY EQUIPMENT				STN STANDARD	SORTING NUMBER
ELABORATED BY Ing. Kluska M.				NOTE	POSITION NUMBER
TESTED BY					
TECHNOLOGIST		TECHNOLOGIST		OLD DRAWING	DRAWING NUMBER
NAME			Roof covering ridge capping		
			Number of sheets		KRS-PKRSH
			Sheet 		

Created: 06.06.2026 09:46:23

Technical changes reserved