

TECHNICAL SHEET

# ROOF COVERING RIDGE CAPPING

# KRS-PKRSH

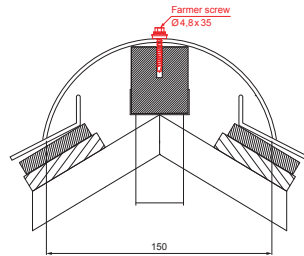

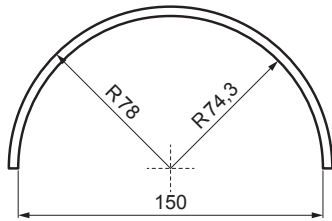
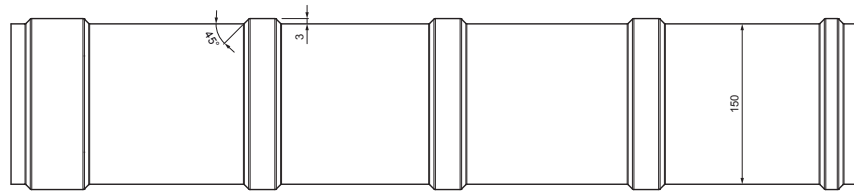
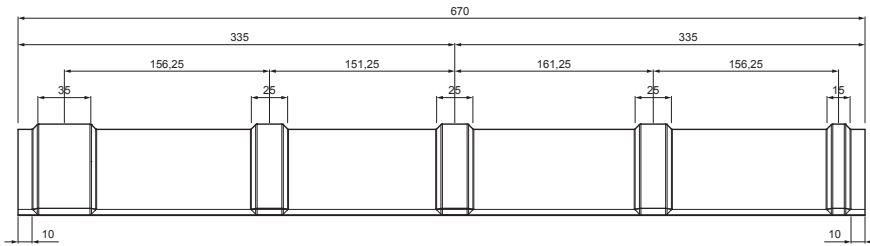

**DETAIL:**

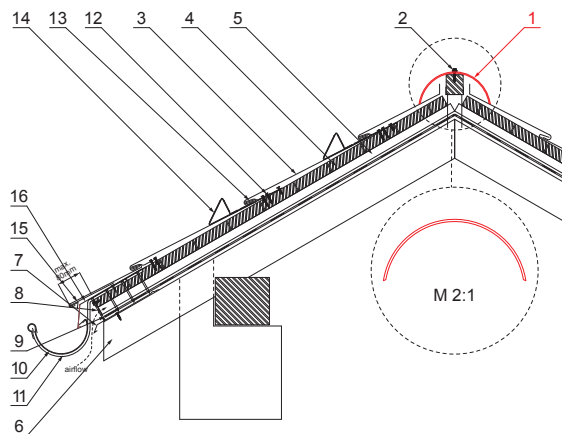
- 1. roof covering ridge capping
- 2. farmer screw 4,8x35
- 3. roof covering KJG rhomboid roof tile
- 4. roof battens
- 5. rafters
- 6. rafter
- 7. drip edge
- 8. protective ventilation belt
- 9. foil
- 10. gutter half-round
- 11. hook
- 12. screw with TORX head for clip
- 13. clip for rhomboid roof tile stainless steel
- 14. nose snow stopper for rhomboid roof tile
- 15. base strip
- 16. cover sheet



**BHT** Galvanized steel prepainted – Grey aluminum – RAL 9007

INDEX	CHANGE	DATE	SIGNATURE			
MATERIAL BRAND			W.C.	WEIGHT kg	SCALE	
SIZE, SEMI-FINISHED PRODUCTS					STN STANDARD	SORTING NUMBER
AUXILIARY EQUIPMENT					NOTE	
ELABORATED BY Ing. Kluska M.					POSITION NUMBER	
TESTED BY					DRAWING NUMBER	
TECHNOLOGIST			TECHNOLOGIST		OLD DRAWING	DRAWING NUMBER
NAME			Roof covering ridge capping		Number of sheets	KRS-PKRSH Sheet

Created: 06.06.2026 12:50:08

Technical changes reserved