

TECHNICAL SHEET

ROOF COVERING RIDGE CAPPING

KRS-PKRSH

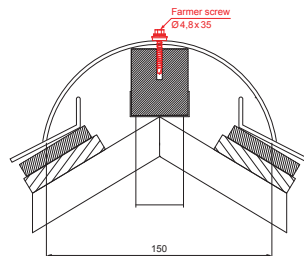

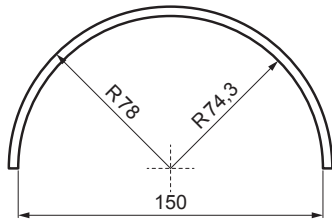
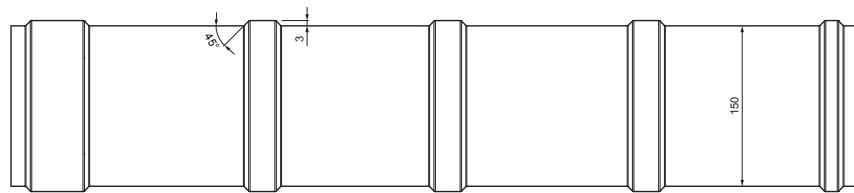
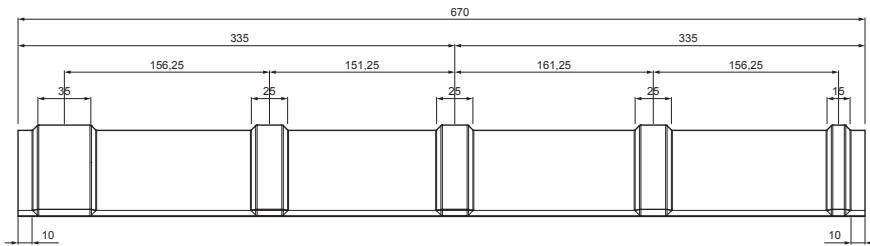

DETAIL:

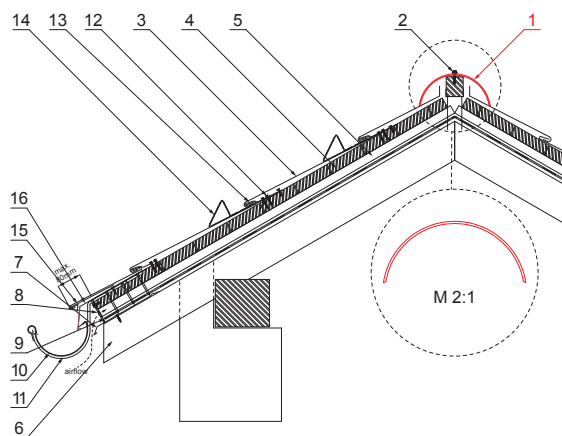
1. roof covering ridge capping
2. farmer screw 4,8x35
3. roof covering KJG rhomboid roof tile
4. roof battens
5. rafter
6. drip edge
7. protective ventilation belt
8. foil
9. gutter half-round
10. hook
11. clip for rhomboid roof tile stainless steel
12. screw with TORX head for clip
13. clip for rhomboid roof tile stainless steel
14. nose snow stopper for rhomboid roof tile
15. base strip
16. cover sheet



MZ Galvanized steel prepainted – Moss green – RAL 6005

INDEX	CHANGE	DATE	SIGNATURE	 	
MATERIAL BRAND			W.C.	WEIGHT kg	SCALE
SIZE, SEMI-FINISHED PRODUCTS				STN STANDARD	SORTING NUMBER
AUXILIARY EQUIPMENT				NOTE	POSITION NUMBER
ELABORATED BY Ing. Kluska M.				OLD DRAWING	DRAWING NUMBER
TESTED BY					
TECHNOLOGIST					
NAME			Roof covering ridge capping		
			Number of sheets		
			KRS-PKRSH		
			Sheet		

Created: 22.04.2026 00:52:41

Technical changes reserved