

TECHNICAL SHEET

ROOF COVERING RIDGE CAPPING

KRS-PKRSH

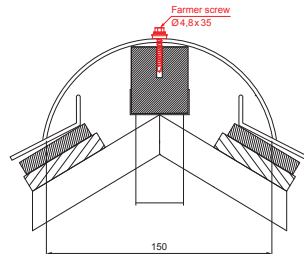

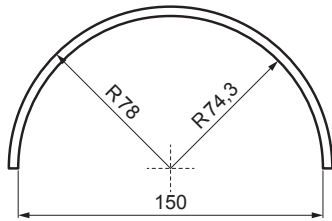
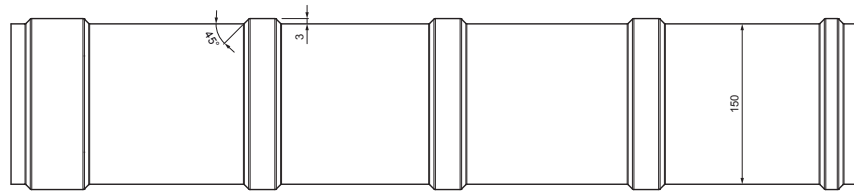
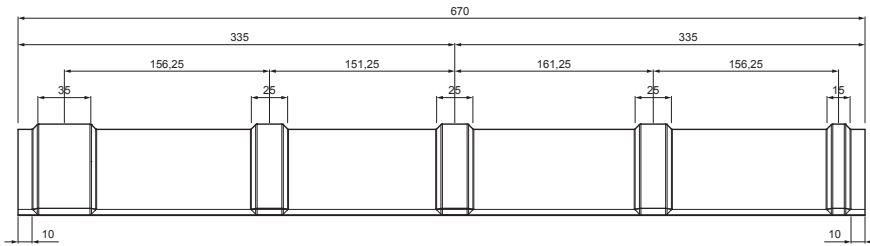

DETAIL:

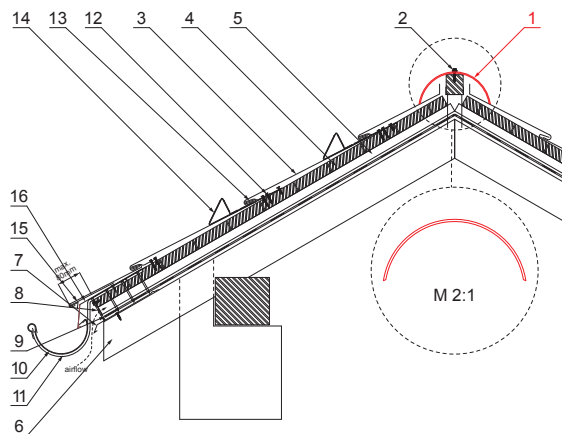
1. roof covering ridge capping
2. farmer screw 4,8x35
3. roof covering KJG rhomboid roof tile
4. roof battens
5. batten
6. rafter
7. drip edge
8. protective ventilation belt
9. foil
10. gutter half-round
11. hook
12. screw with TORX head for clip
13. clip for rhomboid roof tile stainless steel
14. nose snow stopper for rhomboid roof tile
15. base strip
16. cover sheet



ICM Galvanized steel prepainted MATT – Intense black MATT – RAL 9005

| | | | | | |
|------------------------------|--------|------|-----------------------------|---|---|
| INDEX | CHANGE | DATE | SIGNATURE |   | |
| | | | | | |
| MATERIAL BRAND | | | W.C. | WEIGHT kg | SCALE |
| SIZE, SEMI-FINISHED PRODUCTS | | | STN STANDARD | | SORTING NUMBER |
| AUXILIARY EQUIPMENT | | | NOTE | | POSITION NUMBER |
| ELABORATED BY Ing. Kluska M. | | | OLD DRAWING | | DRAWING NUMBER |
| TESTED BY | | | TECHNOLOGIST | | |
| NAME | | | Roof covering ridge capping | | Number of sheets |
| | | | KRS-PKRSH | | Sheet  |

Created: 06.06.2026 12:35:55

Technical changes reserved