

TECHNICAL SHEET

# ROOF COVERING RIDGE CAPPING

# KRS-PKRSH

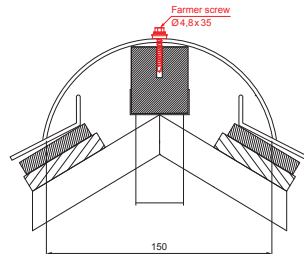

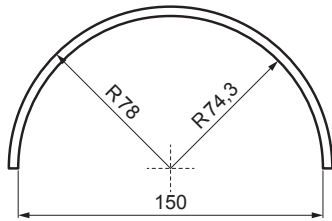
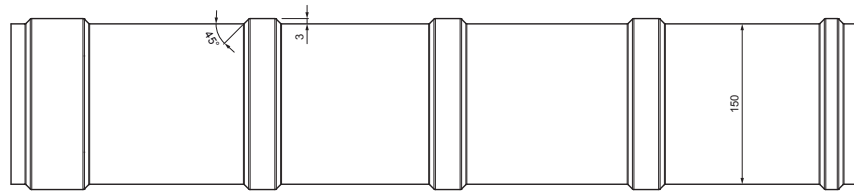
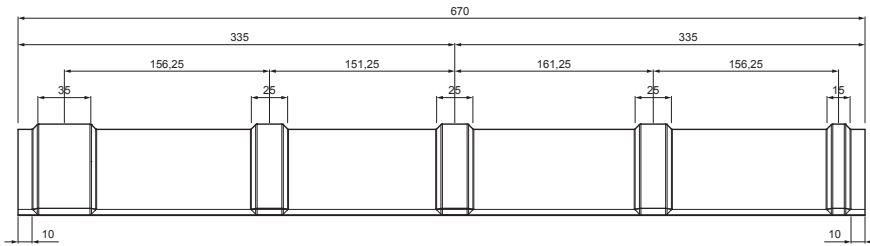

**DETAIL:**

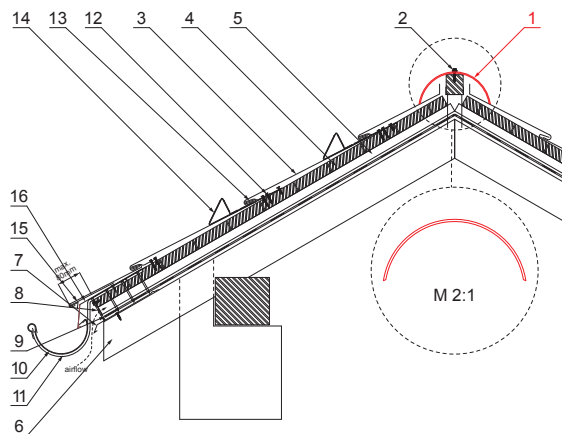
- 1. roof covering ridge capping
- 2. farmer screw 4,8x35
- 3. roof covering KJG rhomboid roof tile
- 4. roof battens
- 5. batten
- 6. rafter
- 7. drip edge
- 8. protective ventilation belt
- 9. foil
- 10. gutter half-round
- 11. hook
- 12. screw with TORX head for clip
- 13. clip for rhomboid roof tile stainless steel
- 14. nose snow stopper for rhomboid roof tile
- 15. base strip
- 16. cover sheet



**TMS** Galvanized steel prepainted STUCCO – Testa di Moro STUCCO – RAL 8028

INDEX	CHANGE	DATE	SIGNATURE	 	
MATERIAL BRAND			W.C.	WEIGHT kg	SCALE
SIZE, SEMI-FINISHED PRODUCTS					
AUXILIARY EQUIPMENT				STN STANDARD	SORTING NUMBER
ELABORATED BY Ing. Kluska M.				NOTE	POSITION NUMBER
TESTED BY					
TECHNOLOGIST		TECHNOLOGIST		OLD DRAWING	DRAWING NUMBER
NAME			Roof covering ridge capping		
			Number of sheets		KRS-PKRSH
			Sheet 		

Created: 07.06.2026 11:01:13

Technical changes reserved