

TECHNICAL SHEET

ROOF COVERING RIDGE CAPPING

KRS-PKRSH

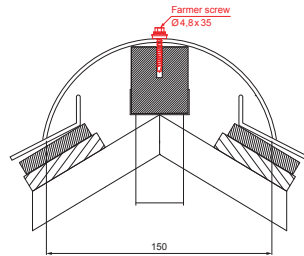

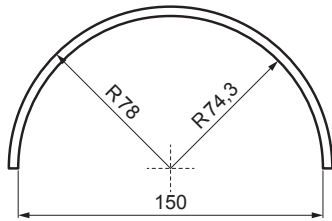
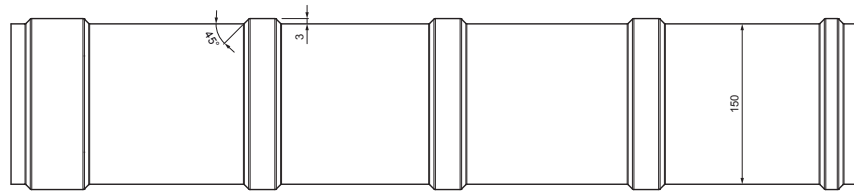
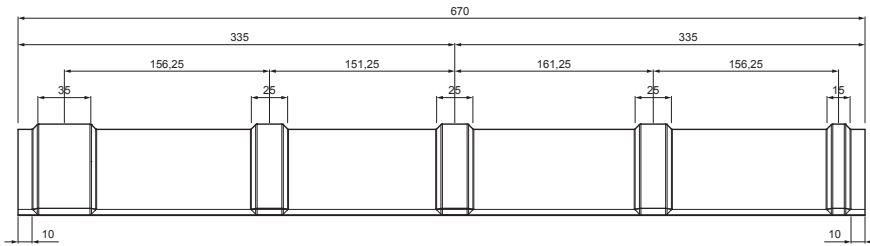

DETAIL:

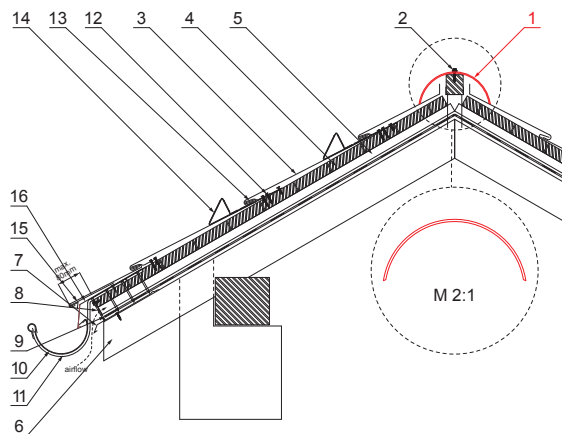
- 1. roof covering ridge capping
- 2. farmer screw 4,8x35
- 3. roof covering KJG rhomboid roof tile
- 4. roof battens
- 5. batten
- 6. rafter
- 7. drip edge
- 8. protective ventilation belt
- 9. foil
- 10. gutter half-round
- 11. hook
- 12. screw with TORX head for clip
- 13. clip for rhomboid roof tile stainless steel
- 14. nose snow stopper for rhomboid roof tile
- 15. base strip
- 16. cover sheet



ICS Galvanized steel prepainted STUCCO – Intense black STUCCO – RAL 9005

INDEX	CHANGE	DATE	SIGNATURE	 	
MATERIAL BRAND			W.C.	WEIGHT kg	SCALE
SIZE, SEMI-FINISHED PRODUCTS					
AUXILIARY EQUIPMENT				STN STANDARD	SORTING NUMBER
ELABORATED BY Ing. Kluska M.				NOTE	POSITION NUMBER
TESTED BY					
TECHNOLOGIST		TECHNOLOGIST		OLD DRAWING	DRAWING NUMBER
NAME			KRS-PKRSH		
Roof covering ridge capping			Number of sheets		Sheet 

Created: 06.06.2026 14:29:45

Technical changes reserved