

TECHNICAL SHEET

# ELBOW SQUARE 72°

# W.15H-WKH

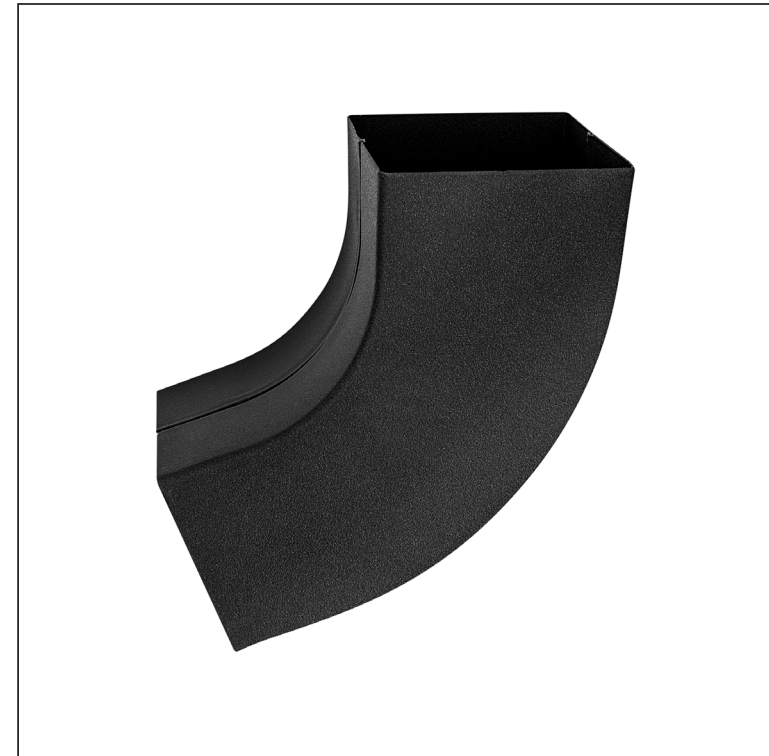
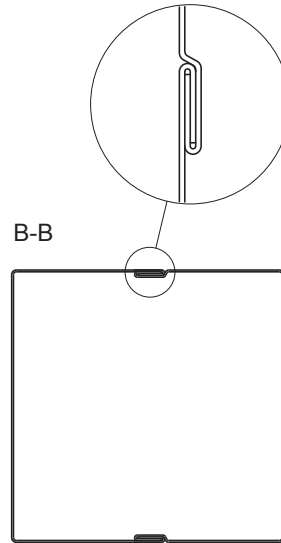
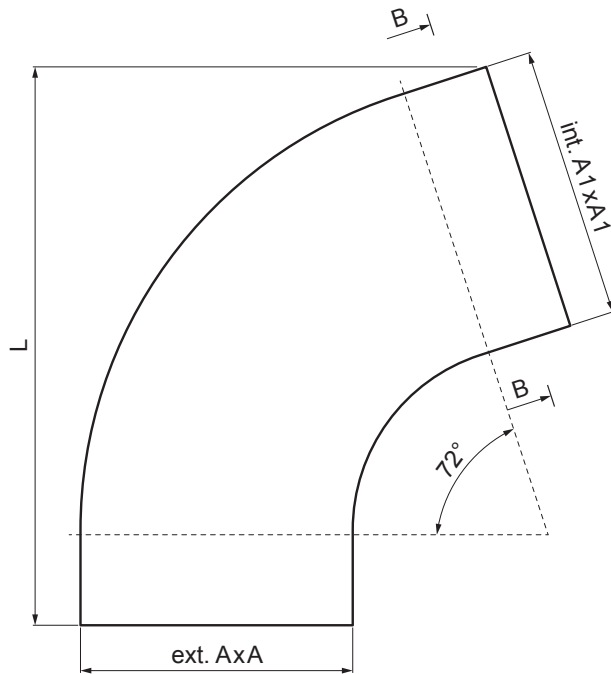

**ICM** Aluminium pre-painted W.15 – Intense black W.15 – RAL 9005

INDEX	CHANGE	DATE	SIGNATURE	<b>KJG</b> QUALITY®	Scan code for 3D model
MATERIAL BRAND			W.C.	WEIGHT kg	SCALE
SIZE, SEMI-FINISHED PRODUCTS				STN STANDARD	SORTING NUMBER
AUXILIARY EQUIPMENT				NOTE	POSITION NUMBER
ELABORATED BY Ing. Kluska M.				OLD DRAWING	DRAWING NUMBER
TESTED BY					
TECHNOLOGIST		TECHNOLOGIST		Number of sheets	W.15H-WKH Sheet
NAME			Elbow square 72°		

Created: 04.06.2026 00:20:38

Technical changes reserved

Dimensions [mm]			
Nominal size	AxA	A1xA1	L
80/80	78 x 78	83 x 83	210
100/100	98 x 98	103 x 103	270



TECHNICAL SHEET

# ELBOW SQUARE 72°

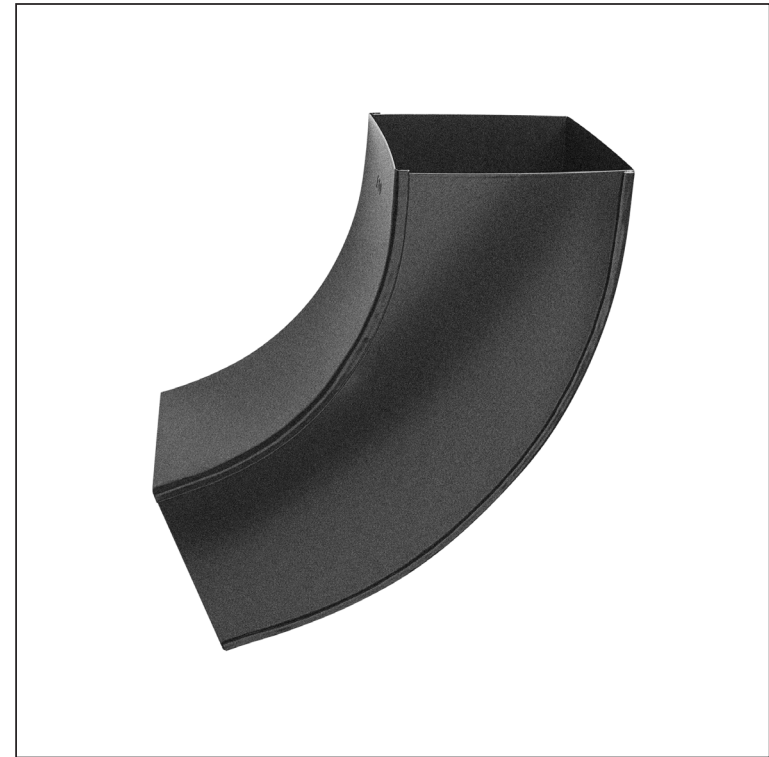
# W.15H-WKH



**ICM** Aluminium preprinted W.15 – Intense black W.15 – RAL 9005

INDEX	ZMENA	DATUM	PODPIS				
ZN. MAT.						T.O.	HMOTNOSŤ kg
ROZM.–POLOT							
POM. ZAR.					STN		TR.Č.
VYPR.	Ing. Kluska M.				POZN.		Č.POZÍCIE
PRESK.							
TECHNOL.		TECHNOL.			STARÝ V.		Č.V.
NÁZOV	Elbow square 72°				Počet listov	W.15H-WKH	List 

Created: 04.06.2026 00:20:38

Technické zmeny vyhradené

Dimensions [mm]			
Nominal size	AxA	A1xA1	L
120/120	118 x 118	123 x 123	300