

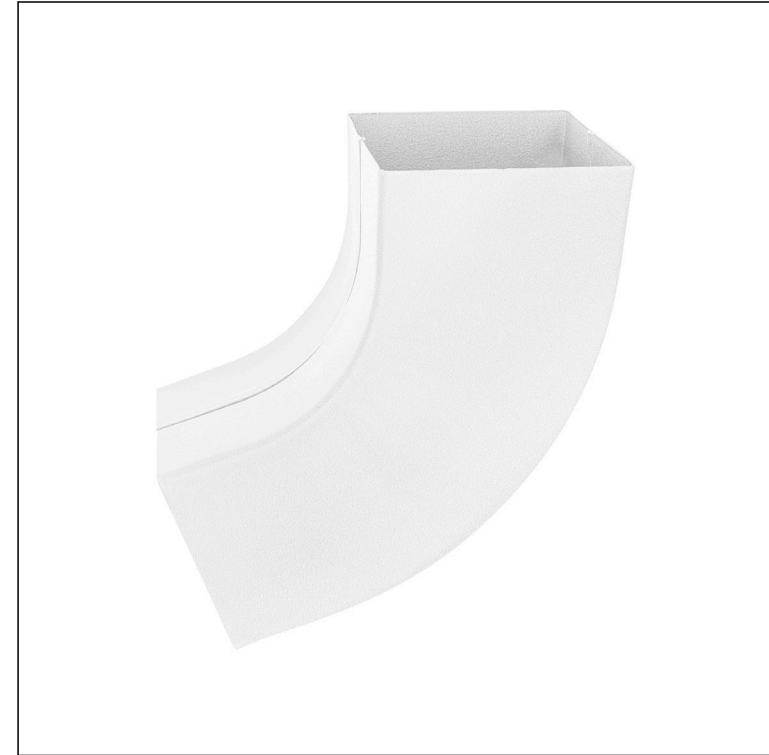

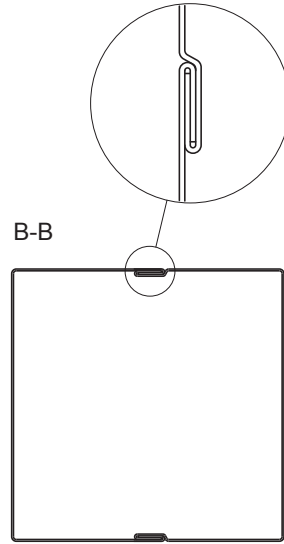

TECHNICAL SHEET

# ELBOW SQUARE 72°

# W.15H-WKH



**BM** Aluminium pre-painted W.15 – Pure white W.15 – RAL 9010

INDEX	CHANGE	DATE	SIGNATURE			
MATERIAL BRAND			W.C.	WEIGHT kg	SCALE	
SIZE, SEMI-FINISHED PRODUCTS				STN STANDARD	SORTING NUMBER	
AUXILIARY EQUIPMENT				NOTE	POSITION NUMBER	
ELABORATED BY Ing. Kluska M.						
TESTED BY						
TECHNOLOGIST		TECHNOLOGIST		OLD DRAWING	DRAWING NUMBER	
NAME				Number of sheets		
Elbow square 72°				W.15H-WKH Sheet 		

Created: 07.06.2026 02:20:56

Technical changes reserved

Dimensions [mm]			
Nominal size	AxA	A1xA1	L
80/80	78 x 78	83 x 83	210
100/100	98 x 98	103 x 103	270



TECHNICAL SHEET

# ELBOW SQUARE 72°

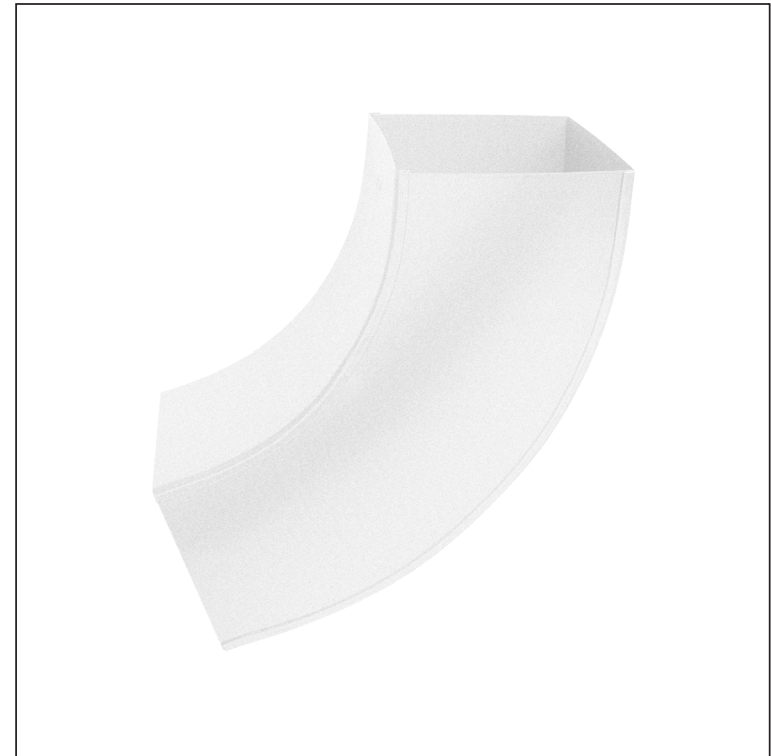
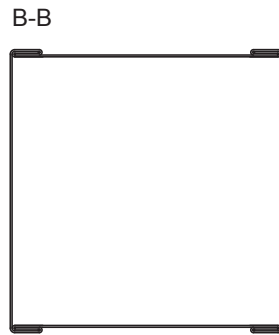
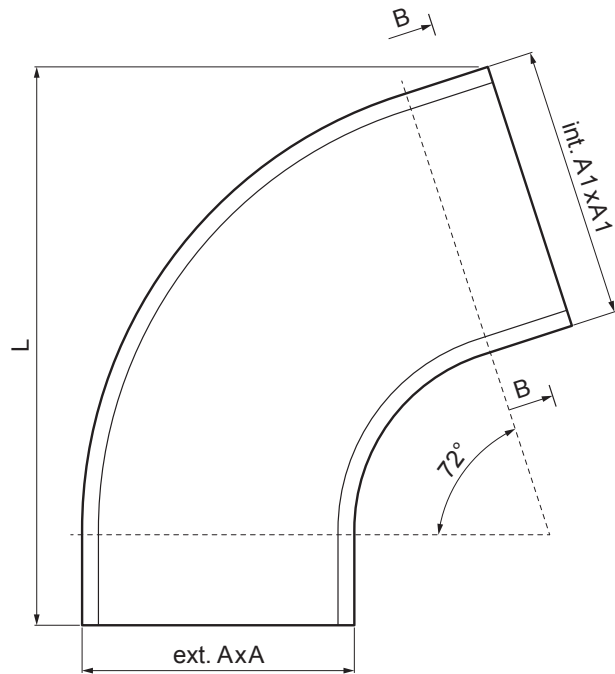
# W.15H-WKH



**BM** Aluminium pre-painted W.15 – Pure white W.15 – RAL 9010

INDEX	ZMENA	DATUM	PODPIS		
ZN. MAT.					
ROZM.–POLOT			T.O.	HMOTNOSŤ kg	MER.
POM. ZAR.				STN	TR.Č.
VYPR.	Ing. Kluska M.			POZN.	Č.POZÍCIE
PRESK.					
TECHNOL.		TECHNOL.		STARÝ V.	Č.V.
NÁZOV	Elbow square 72°			Počet listov	W.15H-WKH List 

Created: 07.06.2026 02:20:56

Technické zmeny vyhradené

Dimensions [mm]			
Nominal size	AxA	A1xA1	L
120/120	118 x 118	123 x 123	300