

TECHNICAL SHEET

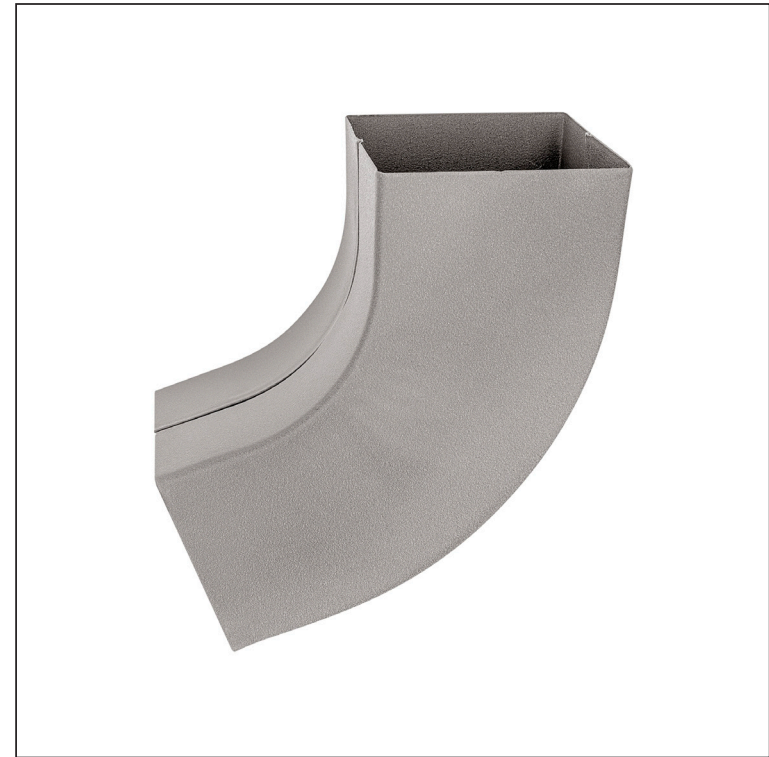

ELBOW SQUARE 72°

W.15H-WKH

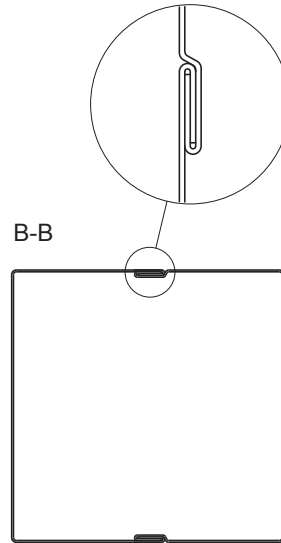
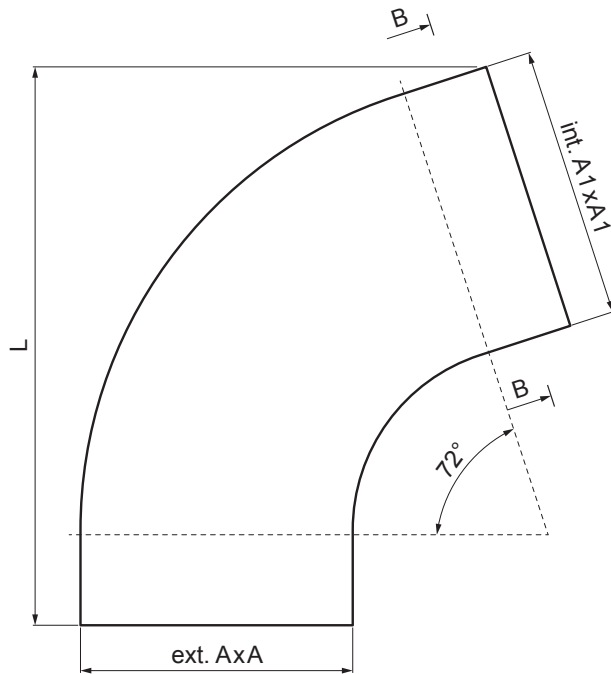

BHTM Aluminium pre-painted W.15 – Grey aluminium W.15 – RAL 9007

Dimensions [mm]			
Nominal size	AxA	A1xA1	L
80/80	78 x 78	83 x 83	210
100/100	98 x 98	103 x 103	270

INDEX	CHANGE	DATE	SIGNATURE	 	
MATERIAL BRAND			W.C.	WEIGHT kg	SCALE
SIZE, SEMI-FINISHED PRODUCTS				STN STANDARD	SORTING NUMBER
AUXILIARY EQUIPMENT				NOTE	POSITION NUMBER
ELABORATED BY Ing. Kluska M.				OLD DRAWING	DRAWING NUMBER
TESTED BY					
TECHNOLOGIST			TECHNOLOGIST		
NAME			Elbow square 72°		
			Number of sheets	W.15H-WKH	Sheet 

Created: 04.06.2026 05:23:42

Technical changes reserved



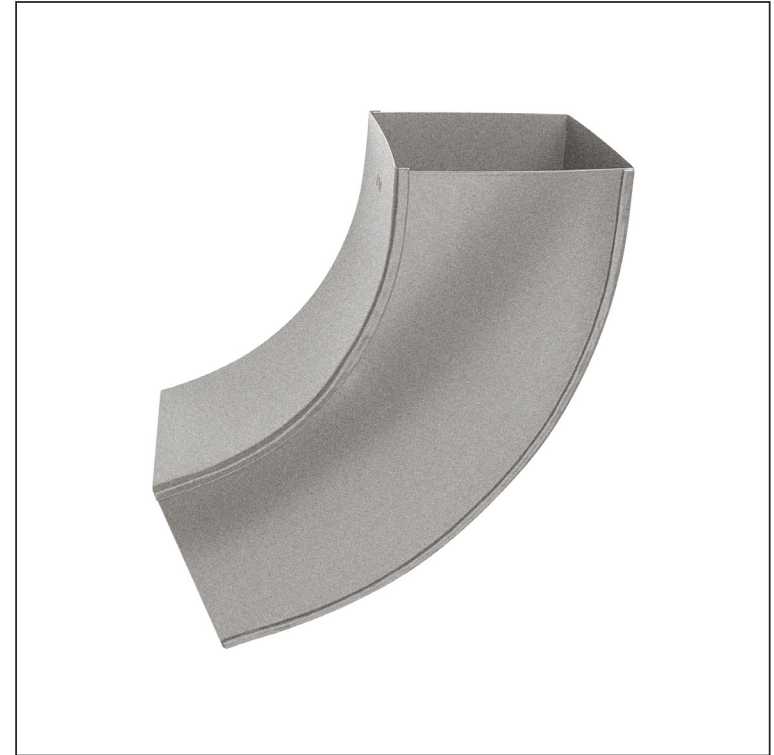
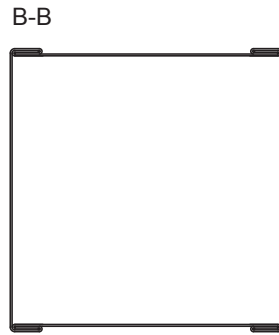

TECHNICAL SHEET

ELBOW SQUARE 72°

W.15H-WKH



BHTM Aluminium pre-painted W.15 – Grey aluminium W.15 – RAL 9007

INDEX	ZMENA	DATUM	PODPIS				
ZN. MAT.							T.O.
ROZM.–POLOT							
POM. ZAR.					STN		TR.Č.
VYPR.	Ing. Kluska M.				POZN.		Č.POZÍCIE
PRESK.							
TECHNOL.		TECHNOL.			STARÝ V.		Č.V.
NÁZOV	Elbow square 72°				Počet listov	W.15H-WKH	List 

Created: 04.06.2026 05:23:42

Technické zmeny vyhradené

Dimensions [mm]			
Nominal size	AxA	A1xA1	L
120/120	118 x 118	123 x 123	300