

TECHNICAL SHEET

RIDGE CAP FOR METAL ROOFING

W-UNI HRE

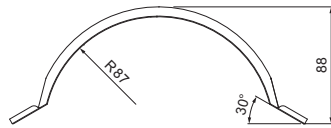

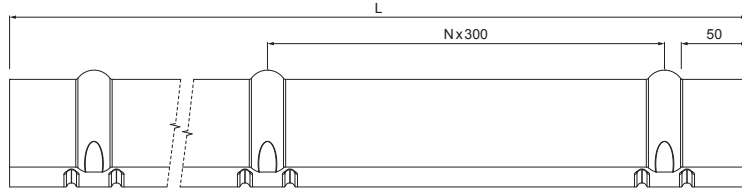

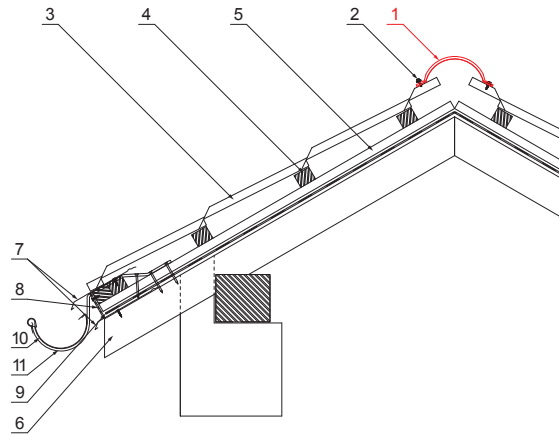

DETAIL:

- 1. ridge cap for metal roofing 2 m or 3 m covering width 1,864 m (2 m) and 2,936 m (3 m)
- 2. farmer screw 4,8x20
- 3. metal roofing
- 4. roof battens
- 5. battens
- 6. rafter
- 7. drip edge
- 8. protective ventilation belt
- 9. foil
- 10. gutter half-round
- 11. hook



BH Aluminium pre-painted – White aluminium – RAL 9006

INDEX	CHANGE	DATE	SIGNATURE			
MATERIAL BRAND			W.C.	WEIGHT kg	SCALE	
SIZE, SEMI-FINISHED PRODUCTS			STN STANDARD		SORTING NUMBER	
AUXILIARY EQUIPMENT			NOTE		POSITION NUMBER	
ELABORATED BY Ing. Kluska M.						
TESTED BY		TECHNOLOGIST		OLD DRAWING	DRAWING NUMBER	
NAME				Number of sheets		W-UNI HRE Sheet 
Ridge cap for metal roofing						

Dimensions [mm]		
Length [m]	L	N
2,0	1925	6

Created: 25.05.2026 03:41:03

Technical changes reserved