

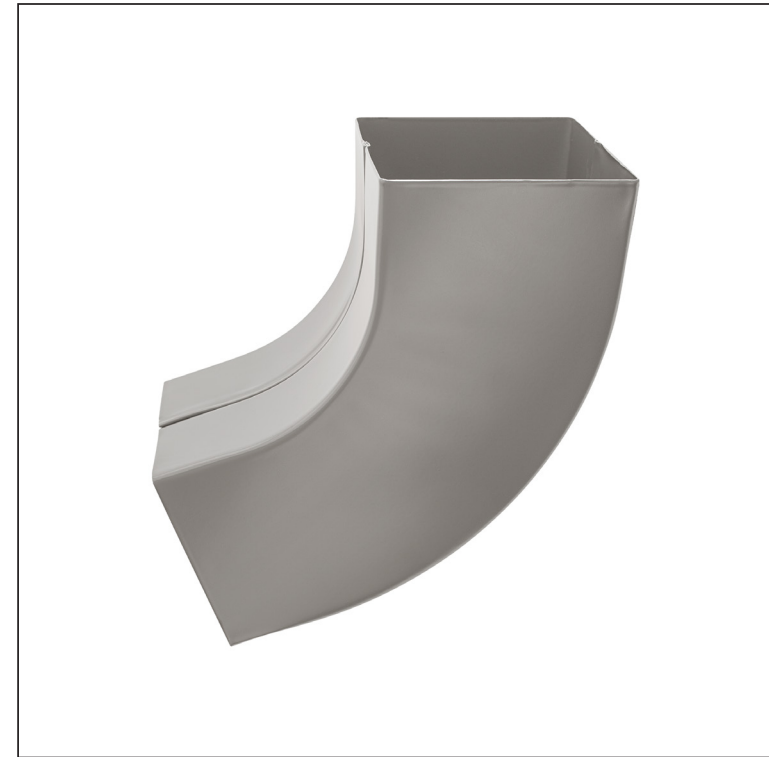

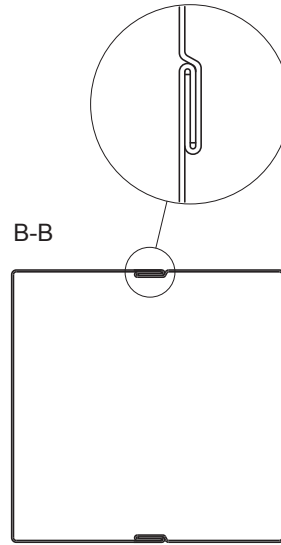

TECHNICAL SHEET

ELBOW SQUARE 72°

WH-WKH



BHT Aluminium pre-painted – Grey aluminum – RAL 9007

INDEX	CHANGE	DATE	SIGNATURE		
MATERIAL BRAND			W.C.	WEIGHT kg	SCALE
SIZE, SEMI-FINISHED PRODUCTS				STN STANDARD	SORTING NUMBER
AUXILIARY EQUIPMENT				NOTE	POSITION NUMBER
ELABORATED BY Ing. Kluska M.				OLD DRAWING	DRAWING NUMBER
TESTED BY					
TECHNOLOGIST			TECHNOLOGIST		
NAME			Elbow square 72°		
			Number of sheets	WH-WKH	Sheet 

Created: 19.04.2026 17:38:20

Technical changes reserved

Dimensions [mm]			
Nominal size	AxA	A1xA1	L
80/80	78 x 78	83 x 83	210
100/100	98 x 98	103 x 103	270



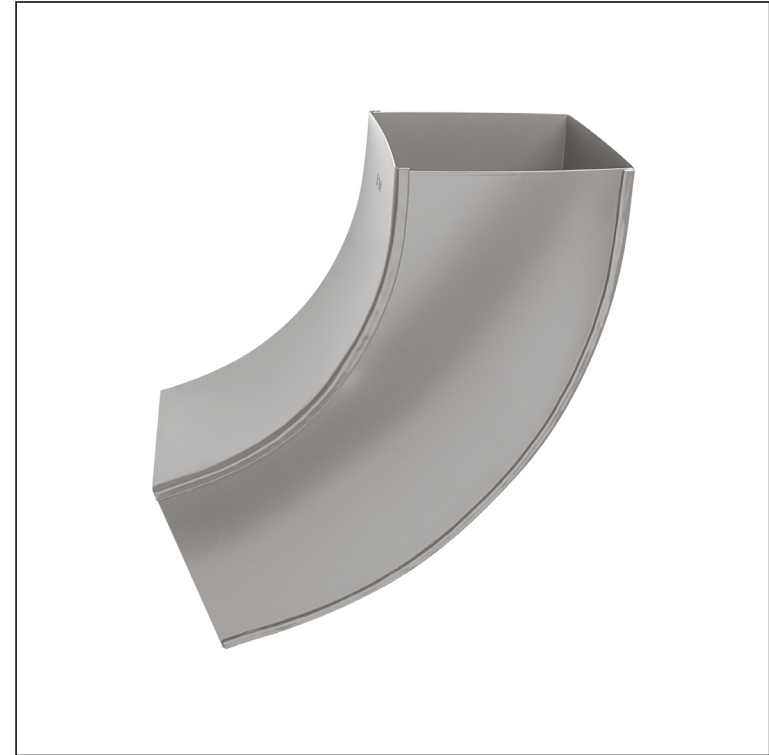

TECHNICAL SHEET

ELBOW SQUARE 72°

WH-WKH



BHT Aluminium pre-painted – Grey aluminum – RAL 9007

INDEX	CHANGE	DATE	SIGNATURE			
MATERIAL BRAND			W.C.	WEIGHT kg	SCALE	
SIZE, SEMI-FINISHED PRODUCTS				STN STANDARD	SORTING NUMBER	
AUXILIARY EQUIPMENT				NOTE	POSITION NUMBER	
ELABORATED BY Ing. Kluska M.				OLD DRAWING	DRAWING NUMBER	
TESTED BY						
TECHNOLOGIST			TECHNOLOGIST			
NAME			Elbow square 72°		Number of sheets	WH-WKH Sheet 

Created: 19.04.2026 17:38:20

Technical changes reserved

Dimensions [mm]			
Nominal size	AxA	A1xA1	L
120/120	118 x 118	123 x 123	300