

TECHNICAL SHEET

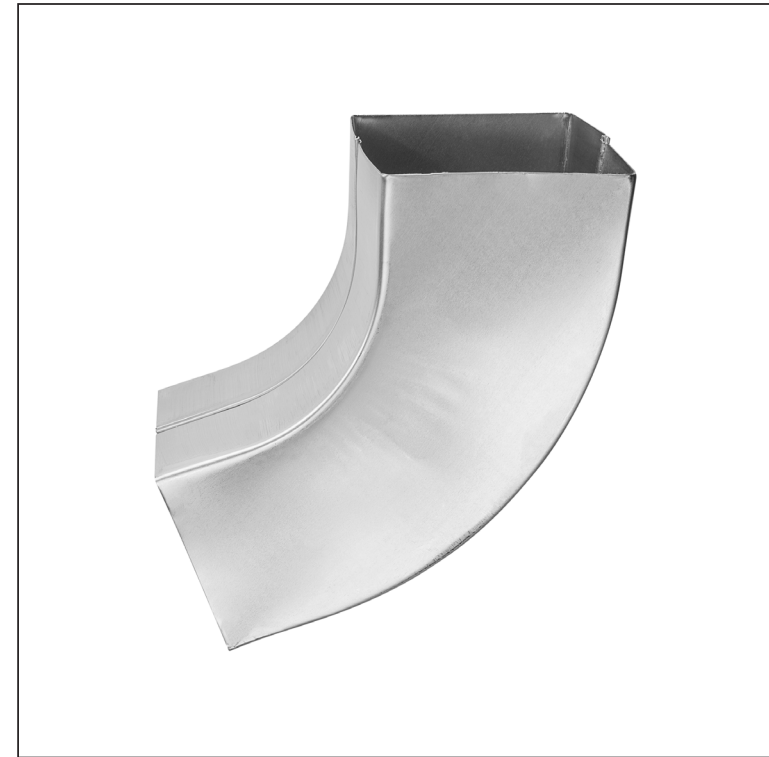

ELBOW SQUARE 72°

TZH-TZKH

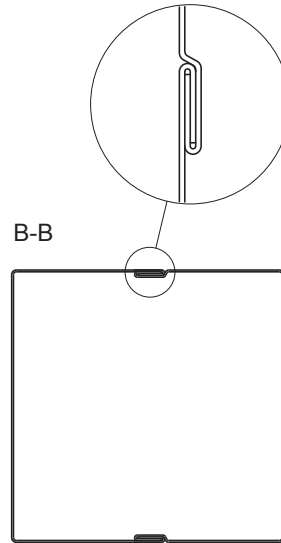
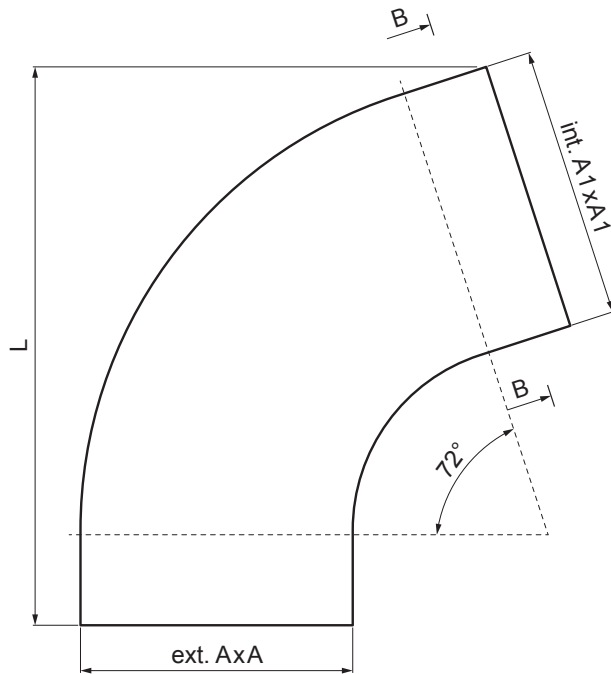

TZ Titanium zinc – Natur

Dimensions [mm]			
Nominal size	AxA	A1xA1	L
80/80	78 x 78	83 x 83	210
100/100	98 x 98	103 x 103	270

INDEX	CHANGE	DATE	SIGNATURE	 	
MATERIAL BRAND			W.C.	WEIGHT kg	SCALE
SIZE, SEMI-FINISHED PRODUCTS				STN STANDARD	SORTING NUMBER
AUXILIARY EQUIPMENT				NOTE	POSITION NUMBER
ELABORATED BY Ing. Kluska M.				OLD DRAWING	DRAWING NUMBER
TESTED BY					
TECHNOLOGIST		TECHNOLOGIST			
NAME			Elbow square 72° TZH-TZKH		
			Number of sheets		Sheet 

Created: 20.04.2026 22:03:17

Technical changes reserved



TECHNICAL SHEET

ELBOW SQUARE 72°

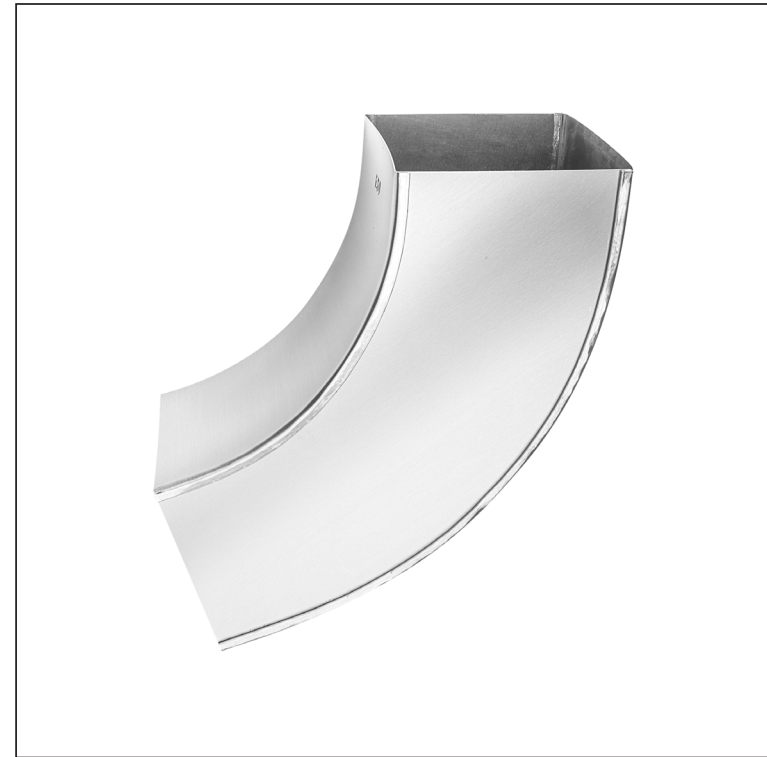
TZH-TZKH



TZ Titanium zinc – Natur

INDEX	CHANGE	DATE	SIGNATURE		
MATERIAL BRAND			W.C.	WEIGHT kg	SCALE
SIZE, SEMI-FINISHED PRODUCTS				STN STANDARD	SORTING NUMBER
AUXILIARY EQUIPMENT				NOTE	POSITION NUMBER
ELABORATED BY Ing. Kluska M.				OLD DRAWING	DRAWING NUMBER
TESTED BY					
TECHNOLOGIST		TECHNOLOGIST			
NAME			Elbow square 72° TZH-TZKH		
			Number of sheets		Sheet 

Created: 20.04.2026 22:03:17

Technical changes reserved

Dimensions [mm]			
Nominal size	AxA	A1xA1	L
120/120	118 x 118	123 x 123	300