

TEHNIČNI LIST

VOGALNIK KVADRATNI NOTRANJI

WH-WRAH

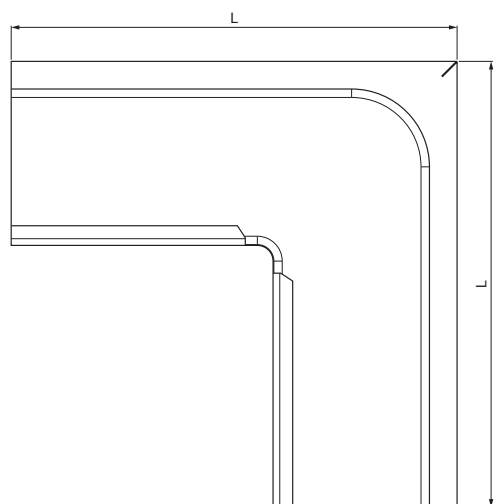
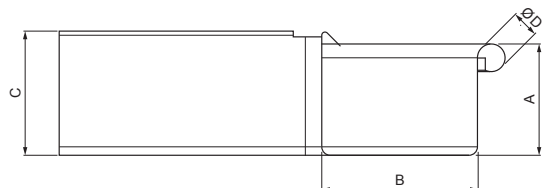

B Aluminij barvni – Bela – RAL 9010

INDEKS			DATUM	PODPIS			
SPREMEMBA							
OZN. MAT.			R.O.	MASA kg	MER.		
DIM.–POLIZD.							
POM. OPR.				STN	RAZVRS.ŠT.		
SEST.	Ing. Kluska M.			OP.	ŠT.POZICIJE		
PREIZK.							
TEHNOL.		TEHNOL.		STARA SK.	ŠT.SK.		
NAZIV	Vogalnik kvadratni notranji			Št. strani	WH-WRAH		Str. 

Kreirano: 06.06.2026 19:06:15

Tehnične spremembe pridržane

Dimenzije [mm]					
Nominalna velikost	A	B	C	ØD	L
250	55	85	65	18	300
333	75	120	85	20	300



TEHNIČNI LIST

VOGALNIK KVADRATNI NOTRANJI

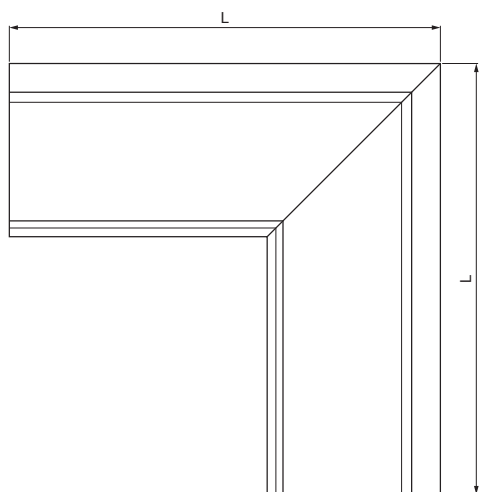
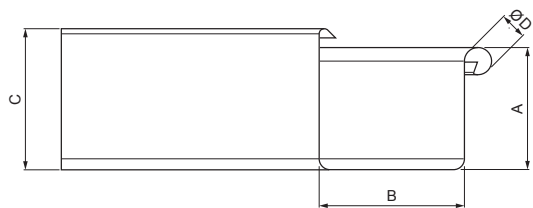
WH-WRAH



B Aluminij barvni – Bela – RAL 9010

INDEKS			DATUM	PODPIS			
SPREMEMBA							
OZN. MAT.			R.O.	MASA kg	MER.		
DIM.–POLIZD.							
POM. OPR.				STN	RAZVRS.ŠT.		
SEST.	Ing. Kluska M.			OP.	ŠT.POZICIJE		
PREIZK.							
TEHNOL.		TEHNOL.		STARA SK.	ŠT.SK.		
NAZIV	Vogalnik kvadratni notranji			Št. strani	WH-WRAH		Str. 

Kreirano: 06.06.2026 19:06:15

Tehnične spremembe pridržane

Dimenzije [mm]					
Nominalna velikost	A	B	C	ØD	L
400	90	150	100	22	400