

TEHNIČNI LIST

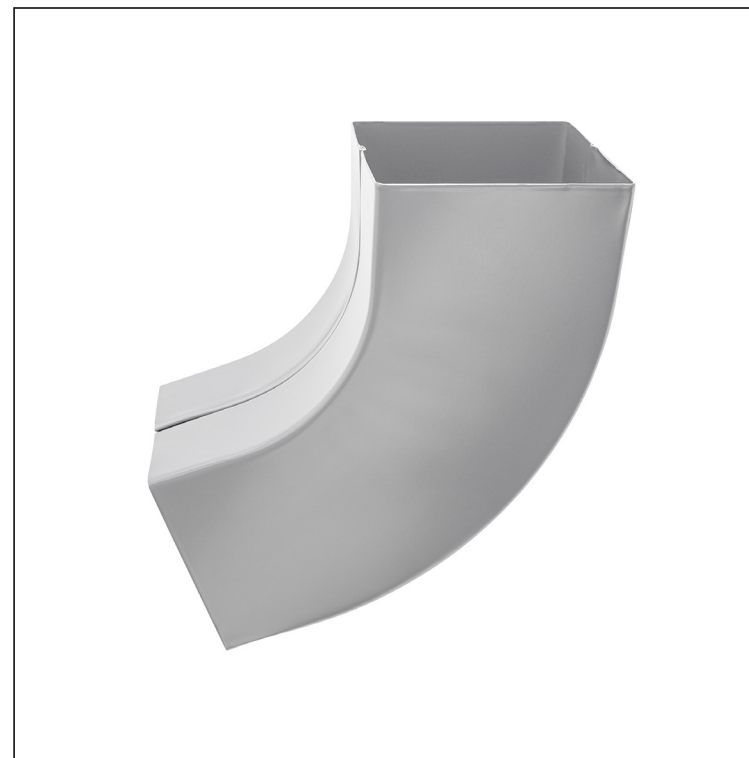



# KOLENO KVADRATNO 72°

# WH-WKH



**BH** Aluminij barvni – Srebrna – RAL 9006

Dimenzije [mm]			
Nominalna velikost	AxA	A1xA1	L
80/80	78 x 78	83 x 83	210
100/100	98 x 98	103 x 103	270

INDEKS		DATUM		PODPIS				
SPREMEMBA								
OZN. MAT.		R.O.		MASA kg		MER.		
DIM.-POLIZD.								
POM. OPR.				STN		RAZVRS.ŠT.		
SEST.	Ing. Kluska M.			OP.		ŠT.POZICIJE		
PREIZK.								
TEHNOL.		TEHNOL.		STARA SK.		ŠT.SK.		
NAZIV	Koleno kvadratno 72°			Št. strani		WH-WKH	Str.	

Kreirano: 07.06.2026 12:18:47

Tehnične spremembe pridržane



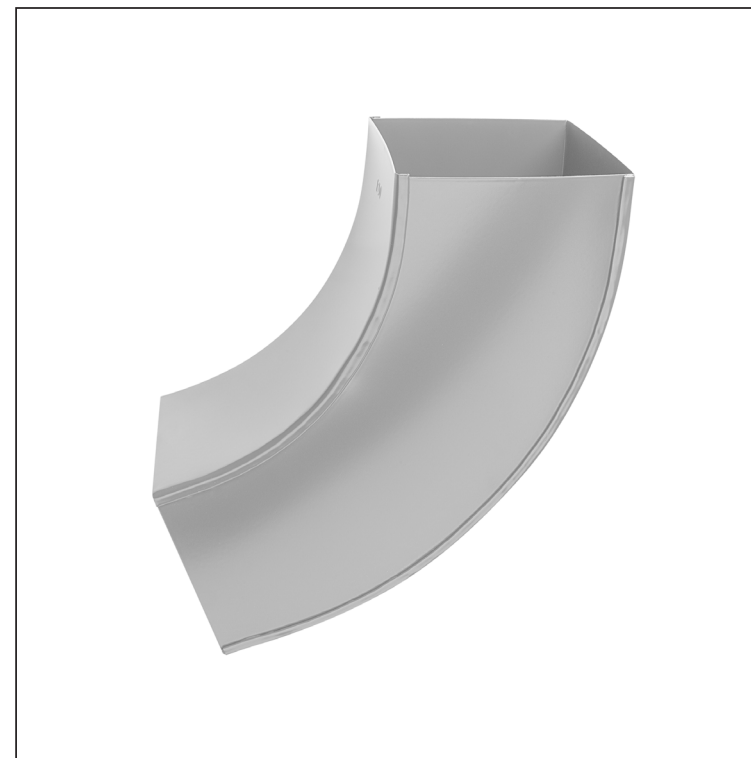

TEHNIČNI LIST

# KOLENO KVADRATNO 72°

WH-WKH



**BH** Aluminij barvni – Srebrna – RAL 9006

INDEKS			DATUM	PODPIS			
SPREMEMBA							
OZN. MAT.			R.O.	MASA kg	MER.		
DIM.-POLIZD.							
POM. OPR.				STN	RAZVRS.ŠT.		
SEST.	Ing. Kluska M.			OP.	ŠT.POZICIJE		
PREIZK.							
TEHNOL.	TEHNOL.			STARA SK.	ŠT.SK.		
NAZIV	Koleno kvadratno 72°			Št. strani	WH-WKH		Str. 

Kreirano: 07.06.2026 12:18:47

Tehnične spremembe pridržane

Dimenzije [mm]			
Nominalna velikost	AxA	A1xA1	L
120/120	118 x 118	123 x 123	300