

TEHNIČNI LIST

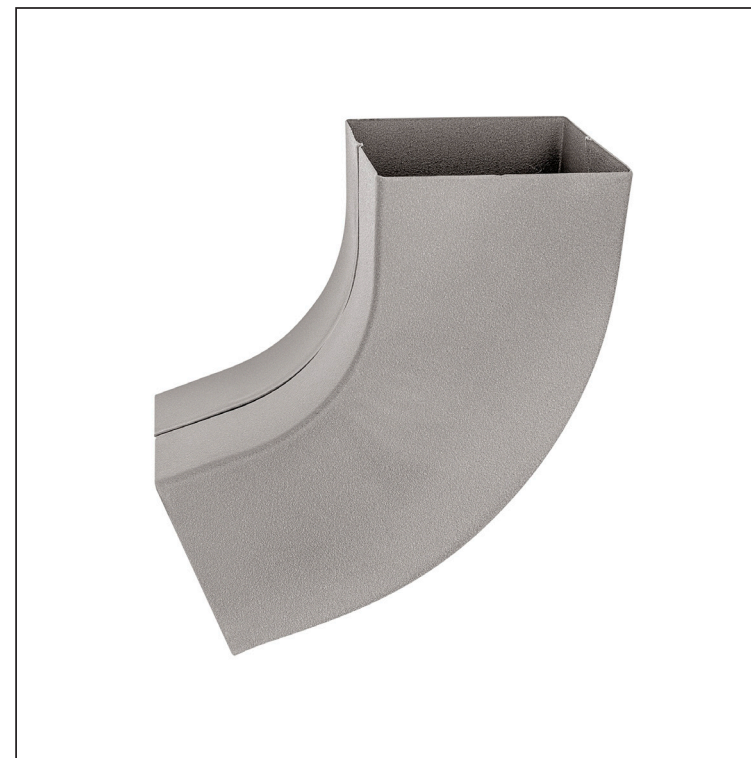

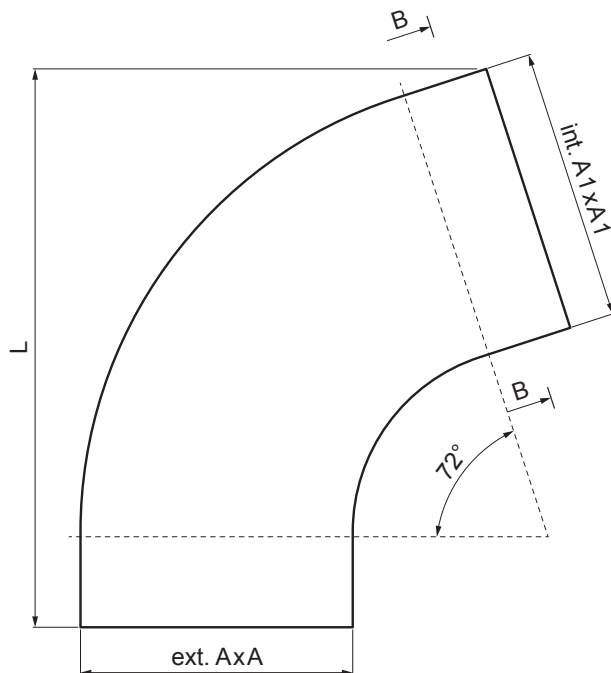

# KOLENO KVADRATNO 72°

## W.15H-WKH



**BHTM** Aluminij barvni W.15 – Temno srebrna W.15 – RAL 9007

Dimenzije [mm]			
Nominalna velikost	AxA	A1xA1	L
80/80	78 x 78	83 x 83	210
100/100	98 x 98	103 x 103	270

INDEKS		DATUM		PODPIS				
SPREMEMBA								
OZN. MAT.		R.O.		MASA kg		MER.		
DIM.-POLIZD.								
POM. OPR.				STN		RAZVRS.ŠT.		
SEST.	Ing. Kluska M.			OP.		ŠT.POZICIJE		
PREIZK.								
TEHNOL.		TEHNOL.		STARA SK.		ŠT.SK.		
NAZIV	Koleno kvadratno 72°			Št. strani		W.15H-WKH	Str.	

Kreirano: 04.06.2026 02:23:34

Tehnične spremembe pridržane

TEHNIČNI LIST



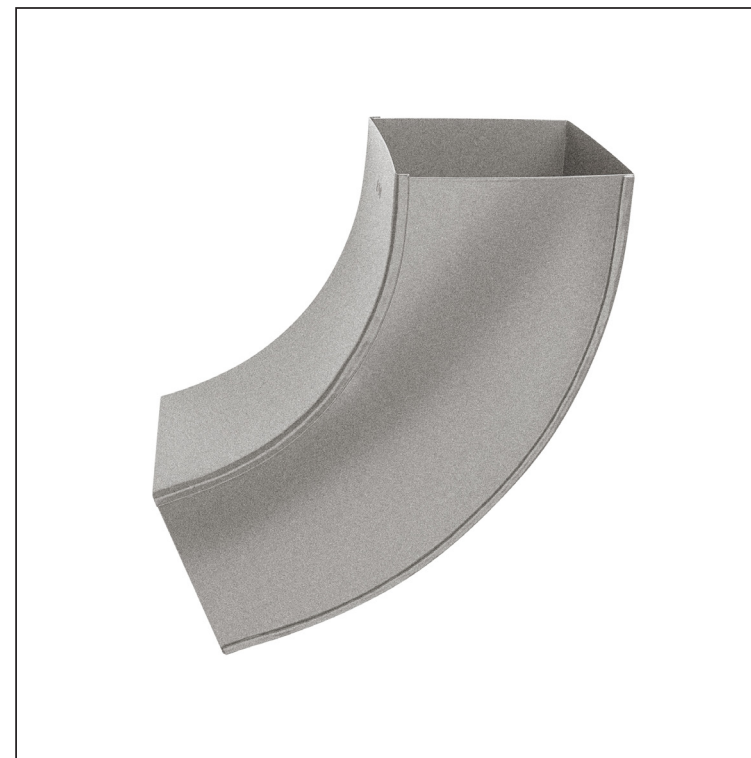

# KOLENO KVADRATNO 72°

## W.15H-WKH



**BHTM** Aluminij barvni W.15 – Temno srebrna W.15 – RAL 9007

Dimenzije [mm]			
Nominalna velikost	AxA	A1xA1	L
120/120	118 x 118	123 x 123	300

INDEKS		DATUM		PODPIS				
SPREMEMBA								
OZN. MAT.		R.O.		MASA kg		MER.		
DIM.-POLIZD.								
POM. OPR.				STN		RAZVRS.ŠT.		
SEST.	Ing. Kluska M.			OP.		ŠT.POZICIJE		
PREIZK.								
TEHNOL.		TEHNOL.		STARA SK.		ŠT.SK.		
NAZIV	Koleno kvadratno 72°			Št. strani		W.15H-WKH	Str.	

Kreirano: 04.06.2026 02:23:34

Tehnične spremembe pridržane