

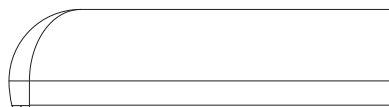



TECHNICKÝ LIST

ŽLABOVÝ ROH VNÚTORNÝ

TZ-TZRI



TZ Titán-zinok – Natur

INDEX	ZMENA	DATUM	PODPIS				
ZN. MAT.							T.O.
ROZM.-POLOT							
POM. ZAR.					STN		TR.Č.
VYPR.	Ing. Kluska M.				POZN.		Č.POZÍCIE
PRESK.							
TECHNOL.		TECHNOL.			STARÝ V.		Č.V.
NÁZOV	Žľabový roh vnútorný				Počet listov	TZ-TZRI	

Rozmery [mm]						
Menovitá veľkosť	A±1	B±1	C min.	ØD±1	ØD1+2/0	L±1
200	5	5	8	16	80	245

Vytvorené: 22.04.2026 10:58:46

Technické zmeny vyhradené

TECHNICKÝ LIST

ŽLABOVÝ ROH VNÚTORNÝ

TZ-TZRI

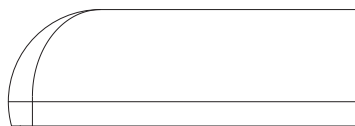
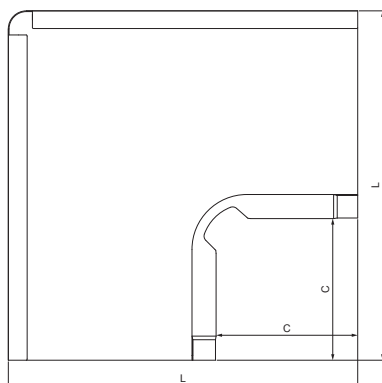
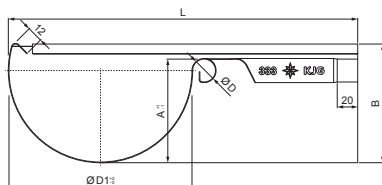

TZ Titán-zinok – Natur

INDEX	ZMENA	DATUM	PODPIS	KJG QUALITY®	Scan code for 3D model	
ZN. MAT.						
ROZM.-POLOT		T.O.		HMOTNOSŤ kg		MER.
POM. ZAR.				STN		TR.Č.
VYPR. Ing. Kluska M.				POZN.		Č.POZÍCIE
PRESK.						
TECHNOL.	TECHNOL.			STARÝ V.		Č.V.
NÁZOV	Žľabový roh vnútorný			Počet listov	TZ-TZRI	
						List

Vytvorené: 22.04.2026 10:58:46

Technické zmeny vyhradené

Rozmery [mm]						
Menovitá veľkosť	A	B	C	ØD	ØD 1	L±1
250	61,5	70,0	137	18	105	260
280	73,0	82,5	130	18	127	275
333	86,5	96,0	117	20	153	290
400	105,0	118,0	106	22	192	340