

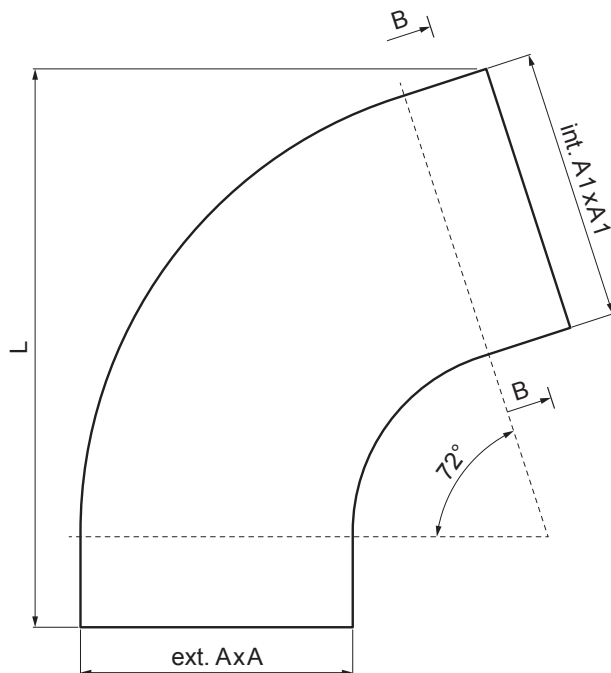



TECHNICKÝ LIST

ZVODOVÉ KOLENO HRANATÉ 72°

PH-PKH



SB Pozink lakovaný – Šedo biela – RAL 9002

INDEX	ZMENA	DATUM	PODPIS				
ZN. MAT.							T.O.
ROZM.-POLOT							
POM. ZAR.					STN		TR.Č.
VYPR.	Ing. Kluska M.				POZN.		Č.POZÍCIE
PRESK.							
TECHNOL.		TECHNOL.			STARÝ V.		Č.V.
NÁZOV	Zvodové koleno hranaté 72°				Počet listov	PH-PKH	List 

Vytvorené: 05.06.2026 21:01:30

Technické zmeny vyhradené

Rozmery [mm]			
Menovitá veľkosť	AxA	A1xA1	L
80/80	78 x 78	83 x 83	210
100/100	98 x 98	103 x 103	270

TECHNICKÝ LIST



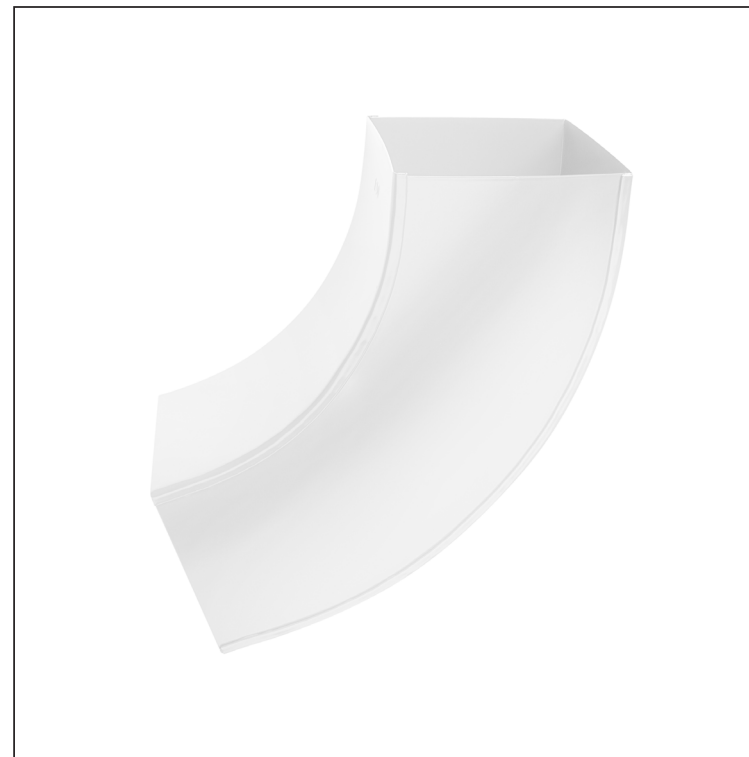

ZVODOVÉ KOLENO HRANATÉ 72°

PH-PKH



SB Pozink lakovaný – Šedo biela – RAL 9002

Rozmery [mm]			
Menovitá veľkosť	AxA	A1xA1	L
120/120	118 x 118	123 x 123	300
150/150	148 x 148	153 x 153	350

INDEX	ZMENA	DATUM	PODPIS	  	
ZN. MAT.					
ROZM.-POLOT			T.O.	HMOTNOSŤ kg	MER.
POM. ZAR.				STN	TR.Č.
VYPR. Ing. Kluska M.				POZN.	Č.POZÍCIE
PRESK.					
TECHNOL.	TECHNOL.			STARÝ V.	Č.V.
NÁZOV	Zvodové koleno hranaté 72°			Počet listov	PH-PKH List 

Vytvorené: 05.06.2026 21:01:30

Technické zmeny vyhradené