

TECHNICKÝ LIST

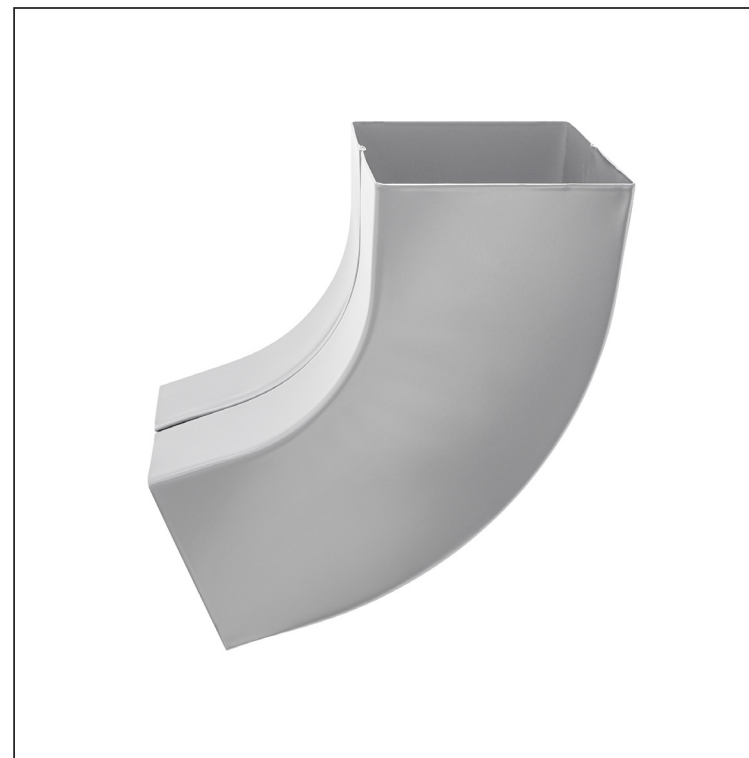

ZVODOVÉ KOLENO HRANATÉ 72°

PH-PKH



BH Pozink lakovaný – Bielo hliníková – RAL 9006

Rozmery [mm]			
Menovitá veľkosť	AxA	A1xA1	L
80/80	78 x 78	83 x 83	210
100/100	98 x 98	103 x 103	270

INDEX	ZMENA	DATUM	PODPIS	  
ZN. MAT.			T.O.	
ROZM.-POLOT				MER.
POM. ZAR.				STN
VYPR. Ing. Kluska M.				TR.Č.
PRESK.				POZN.
TECHNOL.	TECHNOL.			Č.POZÍCIE
NÁZOV	Zvodové koleno hranaté 72°			STARÝ V.
				Č.V.
				Počet listov
				PH-PKH
				List

Vytvorené: 05.06.2026 18:45:15

Technické zmeny vyhradené

TECHNICKÝ LIST



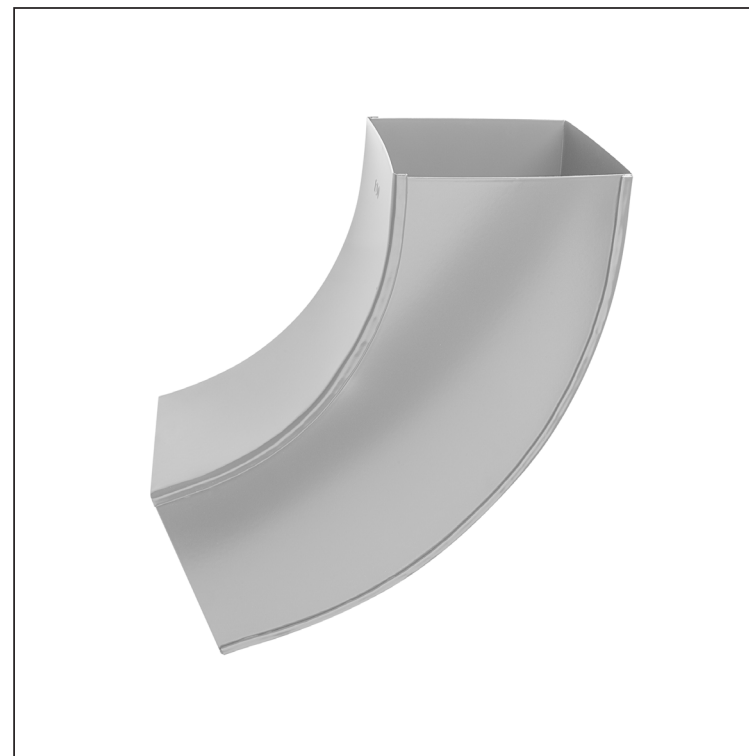

ZVODOVÉ KOLENO HRANATÉ 72°

PH-PKH



BH Pozink lakovaný – Bielo hliníková – RAL 9006

Rozmery [mm]			
Menovitá veľkosť	AxA	A1xA1	L
120/120	118 x 118	123 x 123	300
150/150	148 x 148	153 x 153	350

INDEX	ZMENA	DATUM	PODPIS	  	
ZN. MAT.			T.O.		HMOTNOSŤ kg
ROZM.-POLOT				STN	TR.Č.
POM. ZAR.				POZN.	Č.POZÍCIE
VYPR. Ing. Kluska M.				STARÝ V.	Č.V.
PRESK.					
TECHNOL.	TECHNOL.				
NÁZOV	Zvodové koleno hranaté 72°			Počet listov	PH-PKH
					List 

Vytvorené: 05.06.2026 18:45:15

Technické zmeny vyhradené