

TECHNICKÝ LIST

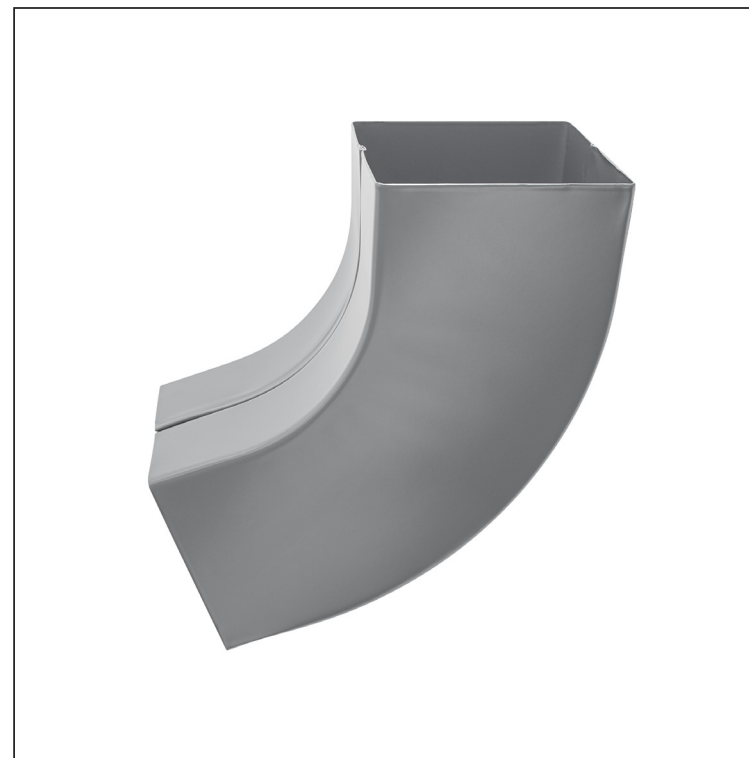



ZVODOVÉ KOLENO HRANATÉ 72°

PH-PKH



PS Pozink lakovaný – Prachovo šedá – RAL 7037

Rozměry [mm]			
Menovitá velikost	AxA	A1xA1	L
80/80	78 x 78	83 x 83	210
100/100	98 x 98	103 x 103	270

INDEX	ZMENA	DATUM	PODPIS	  		
ZN. MAT.			T.O.		HMOTNOST kg	MER.
ROZM.-POLOT				STN	TR.Č.	
POM. ZAR.				POZN.	Č.POZÍCIE	
VYPR. Ing. Kluska M.				STARÝ V.	Č.V.	
PRESK.						
TECHNOL.	TECHNOL.					
NÁZOV	Zvodové koleno hranaté 72°			Počet listov	PH-PKH	List 

Vytvorené: 21.04.2026 20:47:05

Technické zmeny vyhradené

TECHNICKÝ LIST



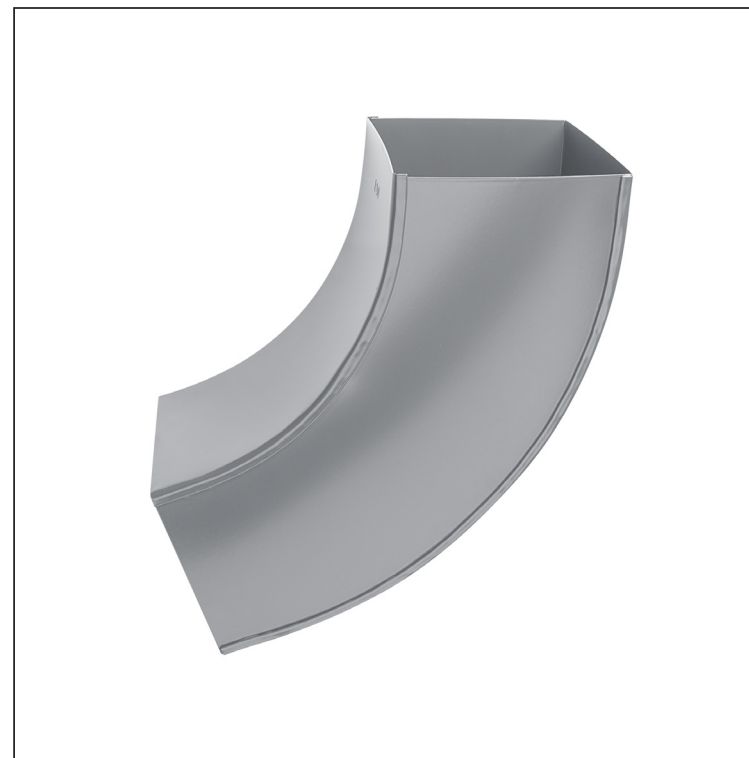

ZVODOVÉ KOLENO HRANATÉ 72°

PH-PKH



PS Pozink lakovaný – Prachovo šedá – RAL 7037

Rozměry [mm]			
Menovitá velikost	AxA	A1xA1	L
120/120	118 x 118	123 x 123	300
150/150	148 x 148	153 x 153	350

INDEX	ZMĚNA	DATUM	PODPIS	  
ZN. MAT.				
ROZM.–POLOT		T.O.	HMOTNOST kg	MER.
POM. ZAR.			STN	TR.Č.
VYPR. Ing. Kluska M.			POZN.	Č.POZÍCIE
PRESK.			STARÝ V.	Č.V.
TECHNOL.	TECHNOL.			
NÁZOV	Zvodové koleno hranaté 72°		Počet listov	PH-PKH List 

Vytvorené: 21.04.2026 20:47:05

Technické zmeny vyhradené