

TECHNICKÝ LIST

EPDM PODLOŽKA POD ZACHYTÁVAČ SNEHU

UNI-ZS PODLOZKA

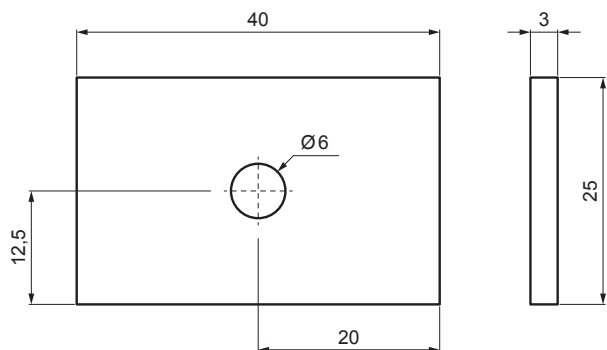



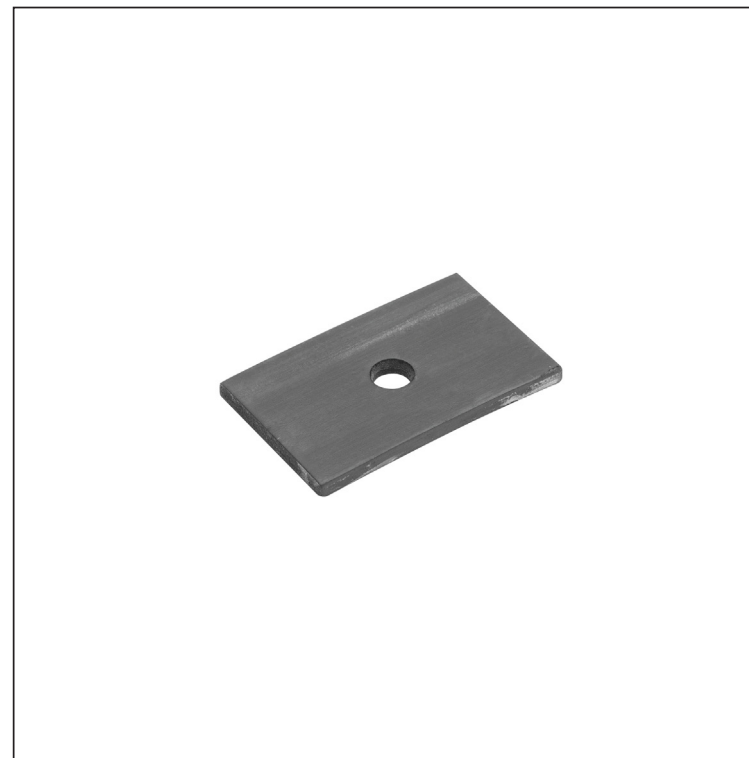

materiál: EPDM čierny  
tvrdosť 65-74 ShA

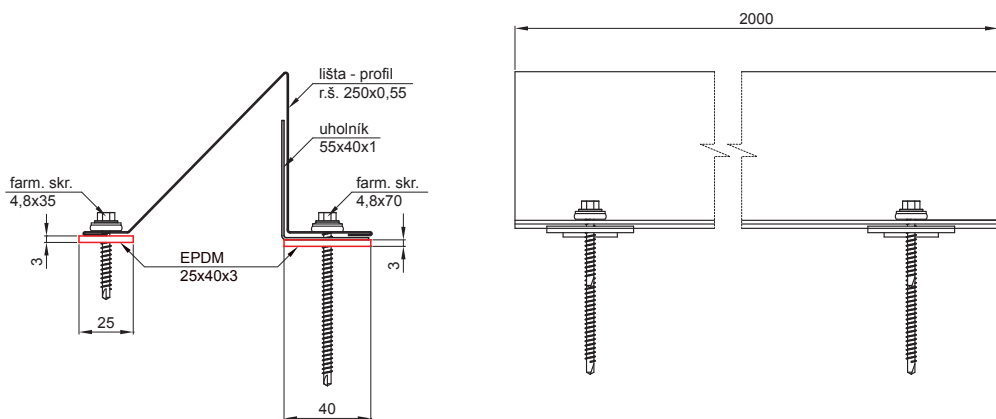

**IC** EPDM – Intenzívna čierna – RAL 9005



INDEX	ZMENA	DATE	PODPIS			
ZN. MAT.	ROZM.-POLOT	T.O.	HMOTNOSŤ kg			
POM. ZAR.	VYPR.	Ing. Kluska M.	POZN.	STN	TR.Č.	
PRESK.	TECHNOL.	TECHNOL.	STARÝ V.	Č.V.		
NÁZOV	EPDM podložka pod zachytávač snehu			Počet listov	UNI-ZS PODLOZKA	List 

Vytvorené: 21.04.2026 03:32:05

Technické zmeny vyhradené