

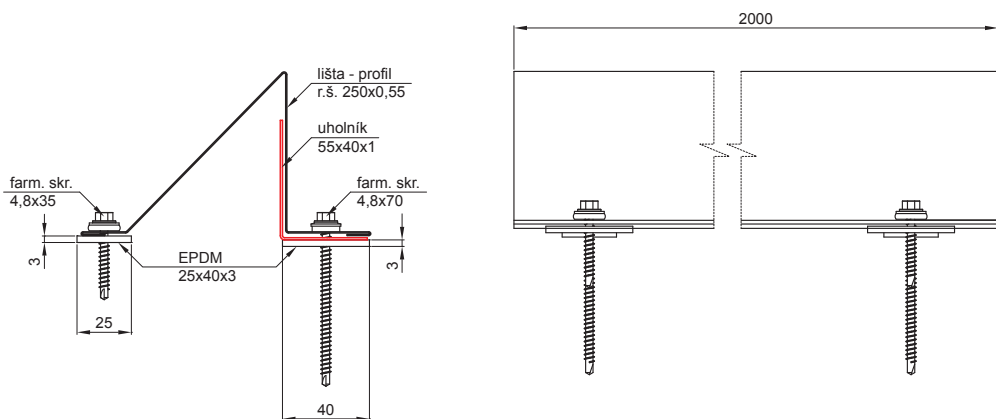

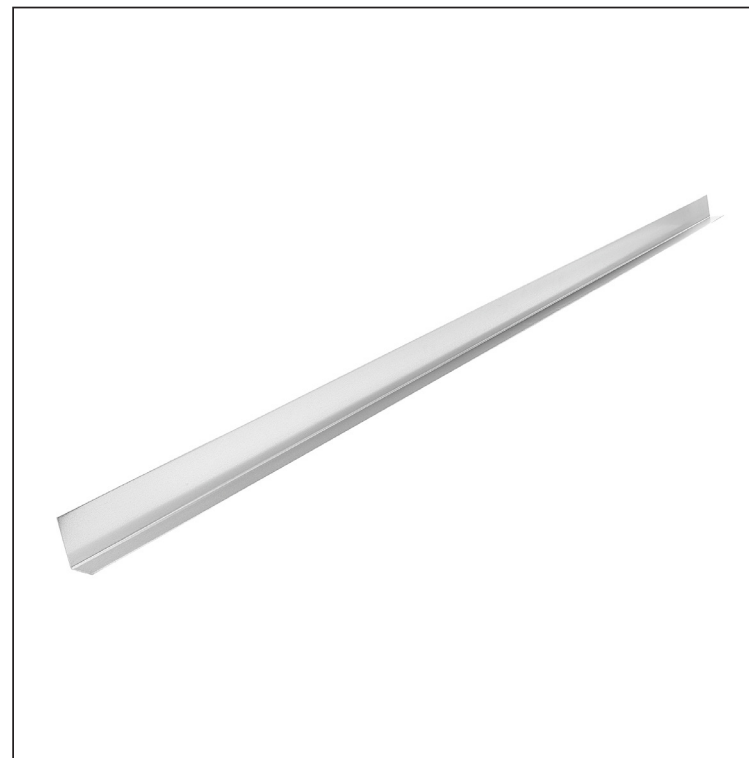
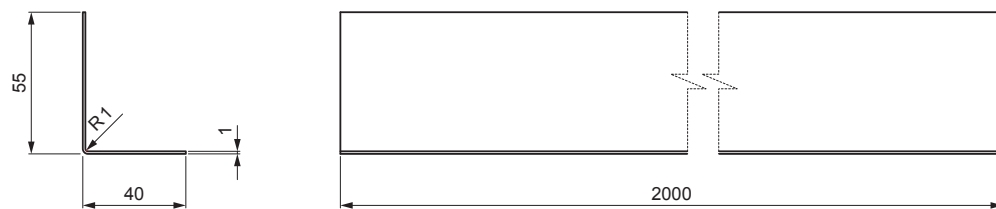

TECHNICKÝ LIST

POZINKOVANÁ VÝSTUŽ ZACHYTÁVAČA SNEHU

UNI-ZS VYSTUZ



P Pozink – Natur

INDEX	ZMENA	DATE	PODPIS			
ZN. MAT.	ROZM.-POLOT	T.O.	HMOTNOSŤ kg			
POM. ZAR.	VYPR.	Ing. Kluska M.	POZN.	STN	TR.Č.	
PRESK.	TECHNOL.		STARÝ V.	Č.V.		
NÁZOV	Pozinkovaná výstuž zachytávača snehu			Počet listov	UNI-ZS VYSTUZ	

Vytvorené: 20.04.2026 14:03:15

Technické zmeny vyhradené