

TECHNICKÝ LIST

STREŠNÝ SCHOD NA KRYTINU UNI

UNI-DACH

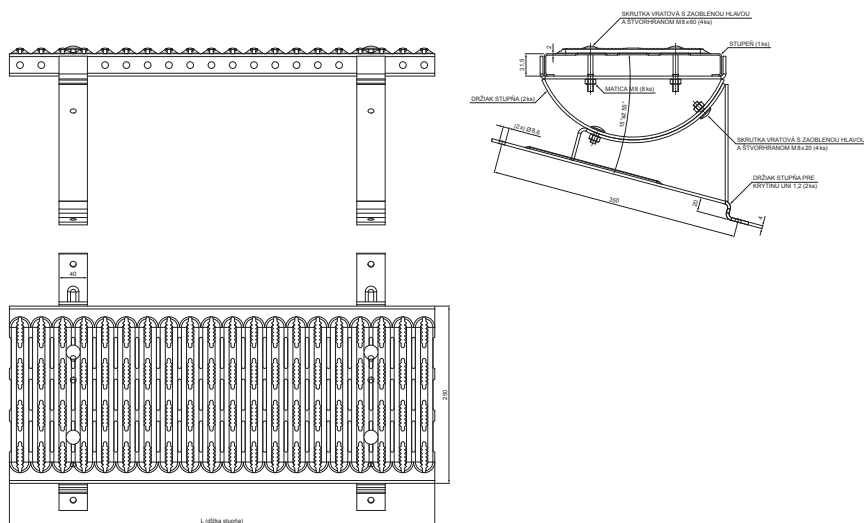



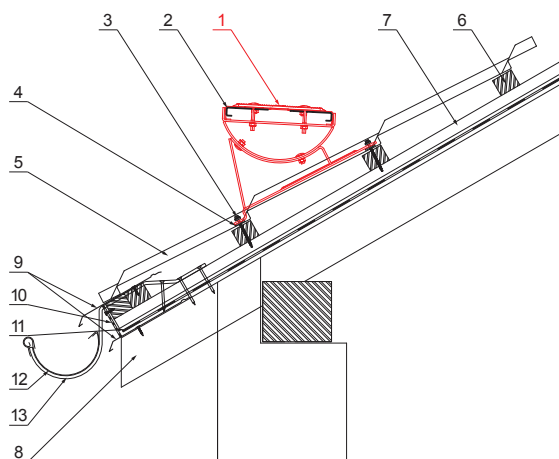

DETAIL:

1. strešný schod na krytinu UNI
2. spojka plošín strešného schodu
3. farmárska skrutka 4,8 x 60
4. EPDM tesnenie 25x40x3
5. strešná plechová krytina
6. strešná lata
7. kontralata
8. krokva
9. odkvapový plech
10. ochranný vetrací pás
11. fólia
12. strešný žľab
13. hák



P Pozink – Natur

INDEX	ZMENA	DATUM	PODPIS	  	
ZN. MAT.			T.O.		HMOTNOSŤ kg
ROZM.–POLOT				STN	TR.Č.
POM. ZAR.				POZN.	Č.POZÍCIE
VYPR. Ing. Kluska M.				STARÝ V.	Č.V.
PRESK.					
TECHNOL.	TECHNOL.				
NÁZOV	Strešný schod na krytinu UNI			Počet listov	UNI-DACH List 

Vytvorené: 21.04.2026 16:22:54

Technické zmeny vyhradené

Rozmery [mm]	
Menovitá veľkosť	L
600	600
800	800

TECHNICKÝ LIST

STREŠNÝ SCHOD NA KRYTINU UNI

UNI-DACH

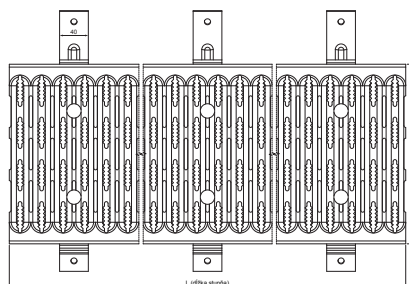
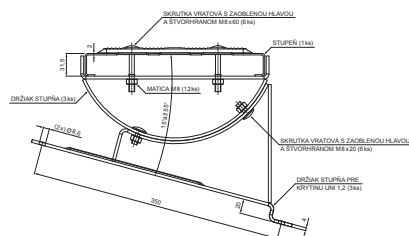
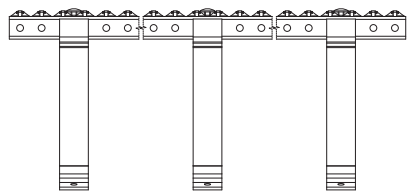



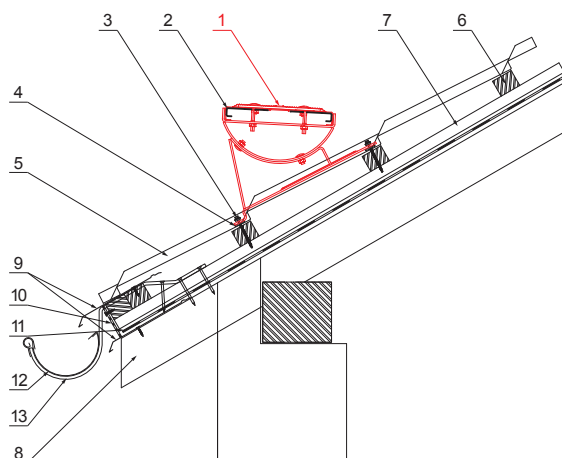

DETAIL:

1. strešný schod na krytinu UNI
2. spojka plošín strešného schodu
3. farmárska skrutka 4,8 x 60
4. EPDM tesnenie 25 x 40 x 3
5. strešná plechová krytina
6. strešná lata
7. kontralata
8. krokva
9. odkvapový plech
10. ochranný vetrací pás
11. fólia
12. strešný žľab
13. hák



P Pozink – Natur

INDEX	ZMENA	DÁTUM	PODPIS	  
ZN. MAT.				
ROZM.–POLOT		T.O.	HMOTNOSŤ kg	MER.
POM. ZAR.			STN	TR.Č.
VYPR. Ing. Kluska M.			POZN.	Č.POZÍCIE
PRESK.				
TECHNOL.	TECHNOL.		STARÝ V.	Č.V.
NÁZOV	Strešný schod na krytinu UNI		Počet listov	UNI-DACH List 

Vytvorené: 21.04.2026 16:22:54

Technické zmeny vyhradené

Rozmery [mm]	
Menovitá veľkosť	L
1200	1200