

# TECHNICKÝ LIST

## STREŠNÝ SCHOD NA KRYTINU UNI

# UNI-DACH

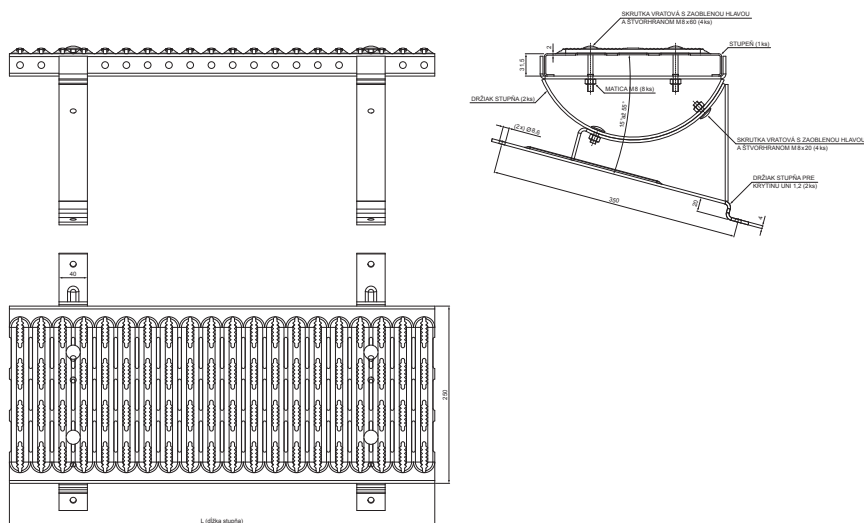



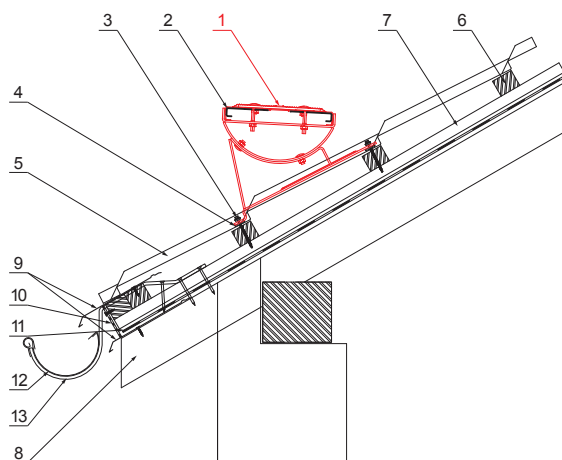

### DETAIL:

1. strešný schod na krytinu UNI
2. spojka plošín strešného schodu
3. farmárska skrutka 4,8 x 60
4. EPDM tesnenie 25x40x3
5. strešná plechová krytina
6. strešná lata
7. kontralata
8. krokva
9. odkvapový plech
10. ochranný vetrací pás
11. fólia
12. strešný žľab
13. hák



**AN** Pozink lakovaný – Antracit – RAL 7016

INDEX	ZMENA	DATUM	PODPIS	  
ZN. MAT.				
ROZM.–POLOT		T.O.	HMOTNOSŤ kg	MER.
POM. ZAR.			STN	TR.Č.
VYPR. Ing. Kluska M.			POZN.	Č.POZÍCIE
PRESK.			STARÝ V.	Č.V.
TECHNOL.	TECHNOL.			
NÁZOV	Strešný schod na krytinu UNI		Počet listov	UNI-DACH List 

Vytvorené: 06.06.2026 03:38:24

Technické zmeny vyhradené

Rozmery [mm]	
Menovitá veľkosť	L
600	600
800	800

# TECHNICKÝ LIST

## STREŠNÝ SCHOD NA KRYTINU UNI

# UNI-DACH

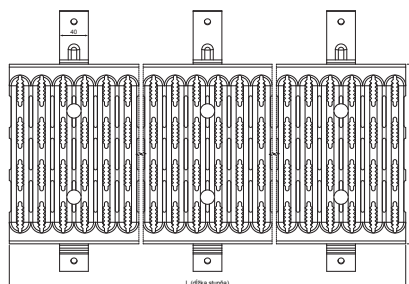
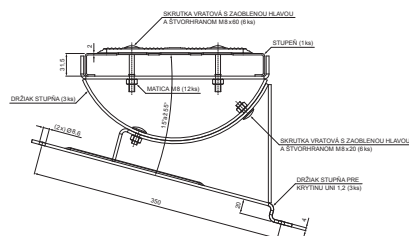
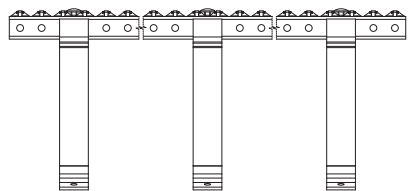



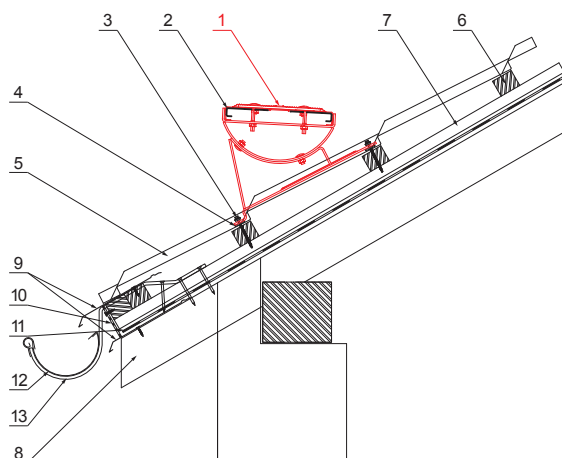

### DETAIL:

1. strešný schod na krytinu UNI
2. spojka plošín strešného schodu
3. farmárska skrutka 4,8 x 60
4. EPDM tesnenie 25 x 40 x 3
5. strešná plechová krytina
6. strešná lata
7. kontralata
8. krokva
9. odkvapový plech
10. ochranný vetrací pás
11. fólia
12. strešný žľab
13. hák



**AN** Pozink lakovaný – Antracit – RAL 7016

INDEX	ZMENA	DATUM	PODPIS	  
ZN. MAT.				
ROZM.–POLOT		T.O.	HMOTNOSŤ kg	MER.
POM. ZAR.			STN	TR.Č.
VYPR. Ing. Kluska M.			POZN.	Č.POZÍCIE
PRESK.				
TECHNOL.	TECHNOL.		STARÝ V.	Č.V.
NÁZOV	Strešný schod na krytinu UNI		Počet listov	UNI-DACH List 

Vytvorené: 06.06.2026 03:38:24

Technické zmeny vyhradené

Rozmery [mm]	
Menovitá veľkosť	L
1200	1200