

TECHNICKÝ LIST

# ZÁVITOVÁ TYČ M10

P-POB-ZT

BOČNÝ POHĽAD

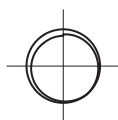



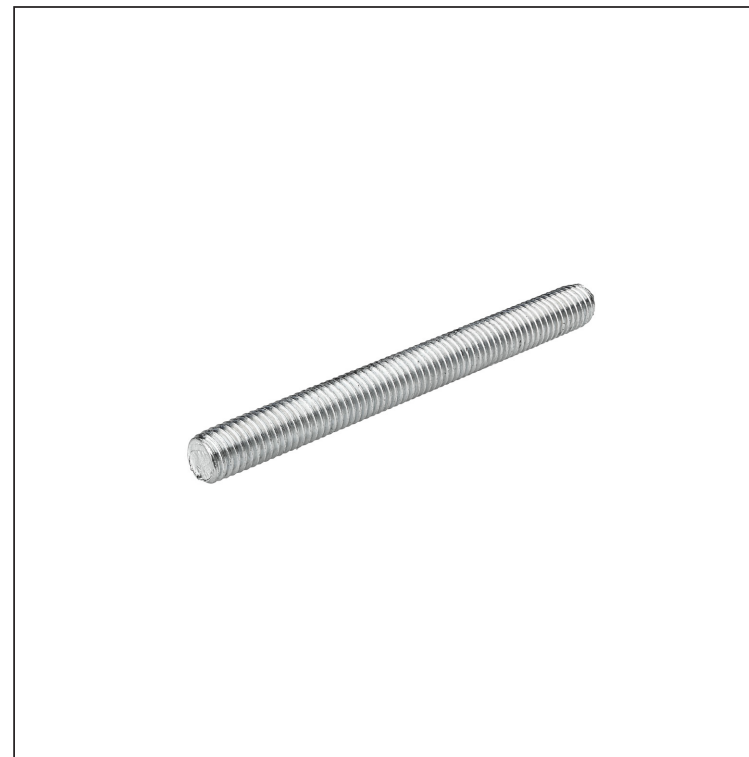
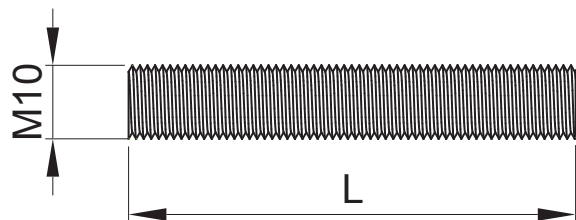

PREDNÝ POHĽAD



**P** Pozink – Natur

Rozmery [mm]	
Menovitá veľkosť	L
60	60
100	100
150	150

INDEX	ZMENA	DATUM	PODPIS			
ZN. MAT.		T.O.				
ROZM.-POLOT				STN	TR.Č.	
POM. ZAR.				POZN.	Č.POZÍCIE	
VYPR. Ing. Kluska M.				STARÝ V.	Č.V.	
PRESK.						
TECHNOL.	TECHNOL.					
NÁZOV	Závitová tyč M10			Počet listov	P-POB-ZT	List 

Vytvorené: 06.06.2026 02:53:47

Technické zmeny vyhradené