

TECHNICKÝ LIST

STREŠNÁ KRYTINA ŠTVOREC

KRS-PKRS

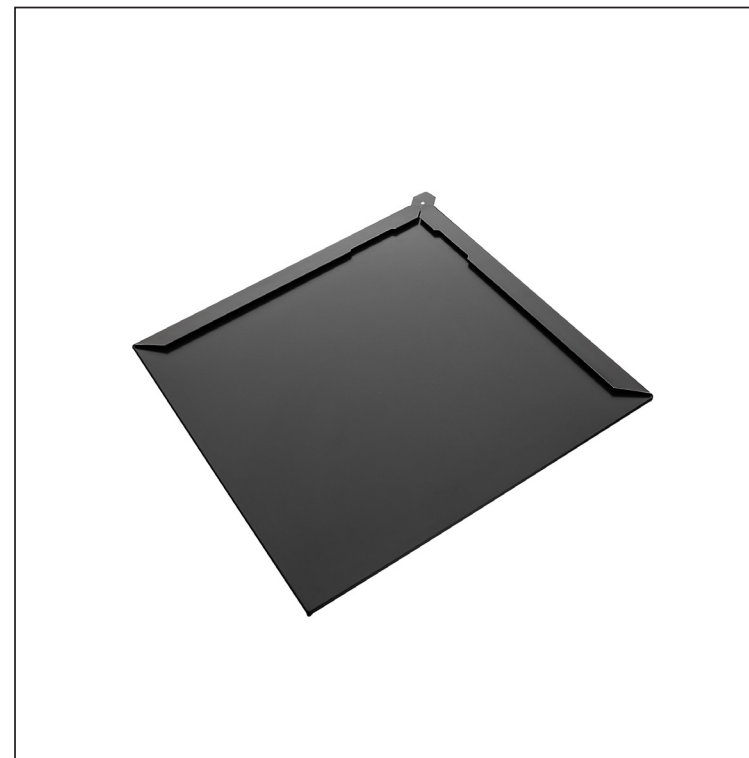

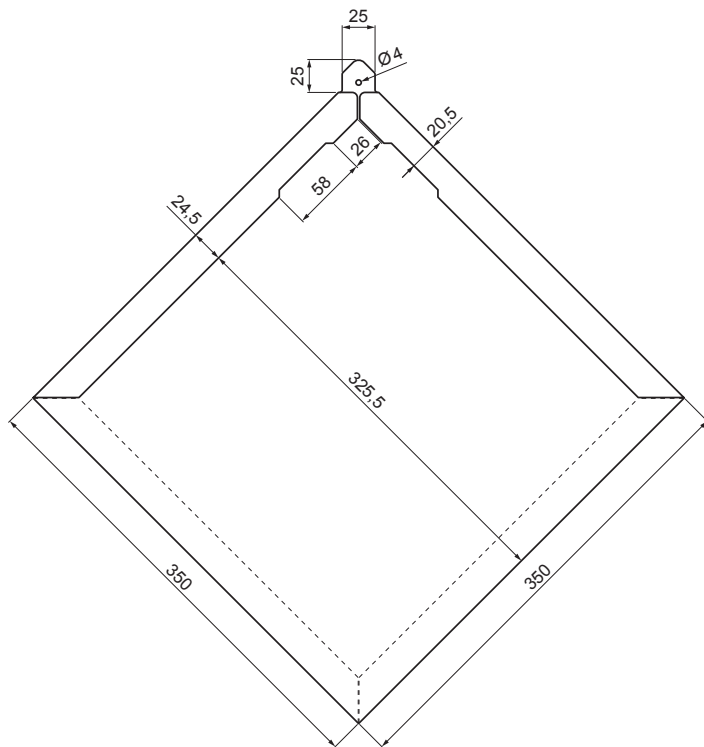

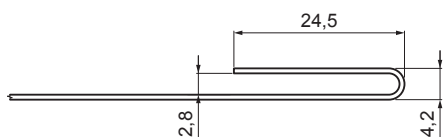

DETAIL OHYBU:



SPOTREBA: 9,47 ks/m²



IC Pozink lakovaný – Intenzívna čierna – RAL 9005

INDEX	ZMENA	DATUM	PODPIS				
ZN. MAT.							T.O.
ROZM.-POLOT							
POM. ZAR.					STN		TR.Č.
VYPR.	Ing. Kluska M.				POZN.		Č.POZÍCIE
PRESK.							
TECHNOL.		TECHNOL.			STARÝ V.		Č.V.
NÁZOV	Strešná krytina štvorec				Počet listov	KRS-PKRS	
						List	

Vytvorené: 22.04.2026 04:51:10

Technické zmeny vyhradené