

TECHNICKÝ LIST

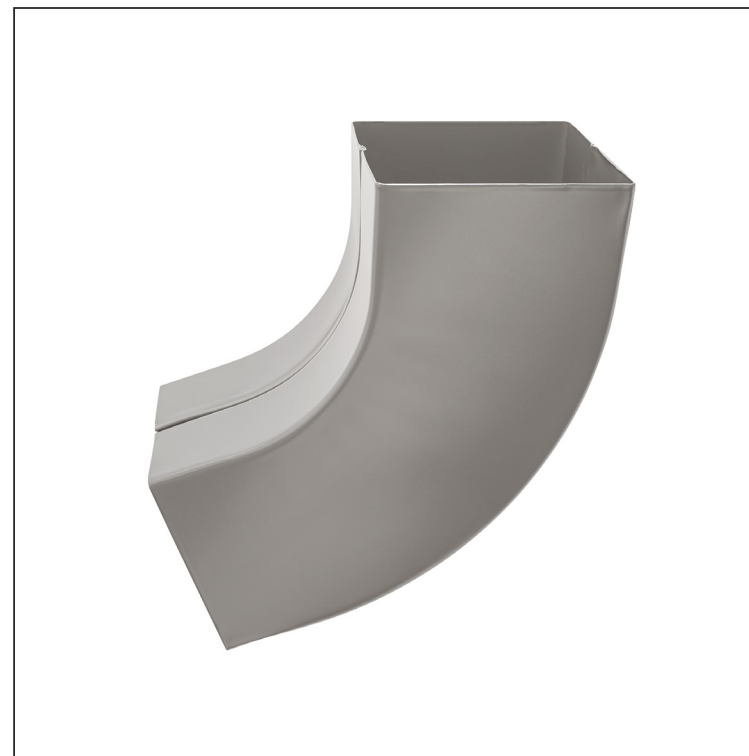



# ZVODOVÉ KOLENO HRANATÉ 72°

## WH-WKH



**BHT** Hliník lakovaný – Bielo hliníková tmavá – RAL 9007

Rozmery [mm]			
Menovitá veľkosť	AxA	A1xA1	L
80/80	78 x 78	83 x 83	210
100/100	98 x 98	103 x 103	270

INDEX	ZMENA	DATUM	PODPIS	  	
ZN. MAT.					
ROZM.-POLOT		T.O.		HMOTNOSŤ kg	MER.
POM. ZAR.				STN	TR.Č.
VYPR. Ing. Kluska M.				POZN.	Č.POZÍCIE
PRESK.					
TECHNOL.	TECHNOL.			STARÝ V.	Č.V.
NÁZOV	Zvodové koleno hranaté 72°			Počet listov	WH-WKH
					List 

Vytvorené: 19.04.2026 17:38:17

Technické zmeny vyhradené



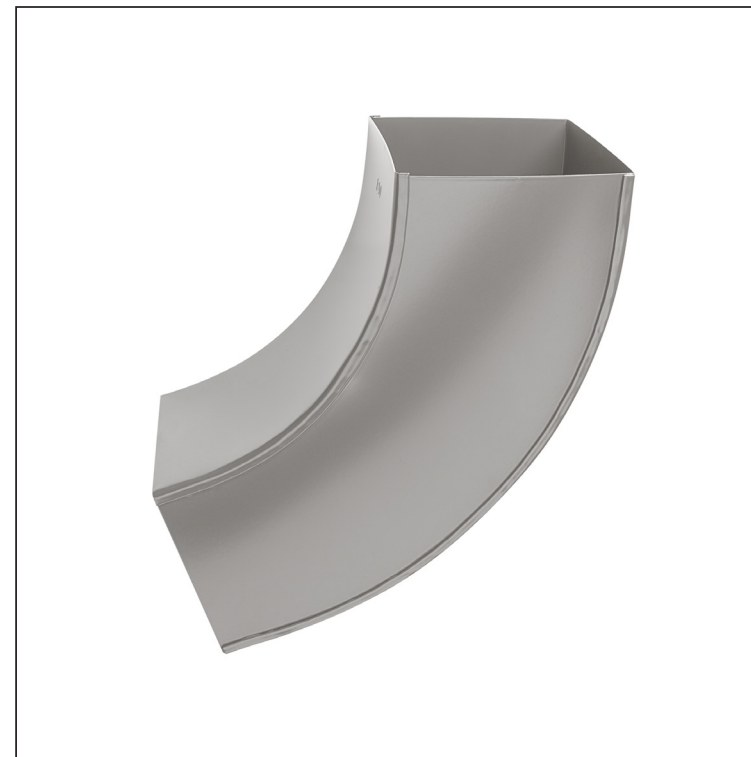

TECHNICKÝ LIST

# ZVODOVÉ KOLENO HRANATÉ 72°

WH-WKH



**BHT** Hliník lakovaný – Bielo hliníková tmavá – RAL 9007

INDEX	ZMENA	DATUM	PODPIS				
ZN. MAT.							T.O.
ROZM.-POLOT							
POM. ZAR.					STN		TR.Č.
VYPR.	Ing. Kluska M.				POZN.		Č.POZÍCIE
PRESK.							
TECHNOL.		TECHNOL.			STARÝ V.		Č.V.
NÁZOV	Zvodové koleno hranaté 72°				Počet listov	WH-WKH	List 

Vytvorené: 19.04.2026 17:38:17

Technické zmeny vyhradené

Rozmery [mm]			
Menovitá veľkosť	AxA	A1xA1	L
120/120	118 x 118	123 x 123	300