

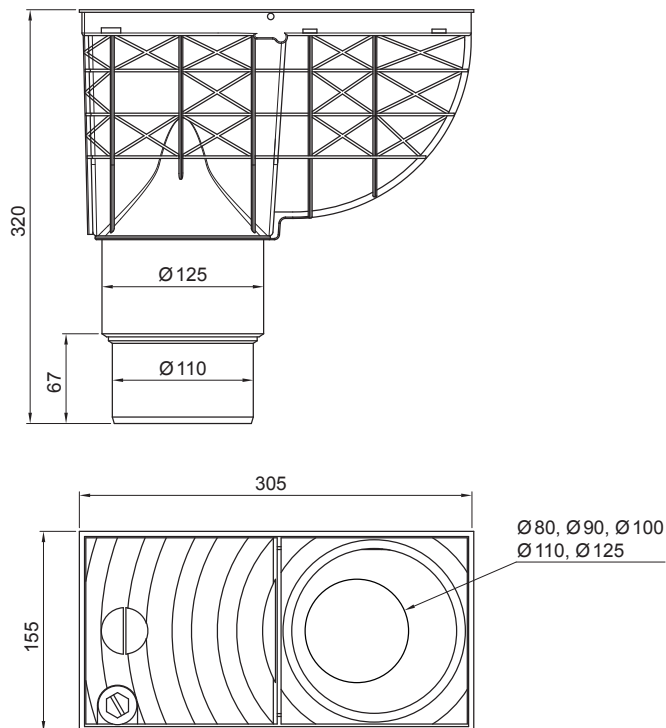



TECHNICKÝ LIST

KANALIZAČNÁ VPUŠŤ PRIAMA

SD-KV AGV4



IC PVC – Intenzívna čierna – RAL 9005

INDEX	ZMENA	DATUM	PODPIS	  			
ZN. MAT.					T.O.	HMOTNOSŤ kg	MER.
ROZM.–POLOT							
POM. ZAR.					STN	TR.Č.	
VYPR.	Ing. Kluska M.				POZN.	Č.POZÍCIE	
PRESK.							
TECHNOL.	TECHNOL.				STARÝ V.	Č.V.	
NÁZOV	Kanalizačná vpusť priama				Počet listov	SD-KV AGV4	List 

Vytvorené: 21.04.2026 16:05:56

Technické zmeny vyhradené



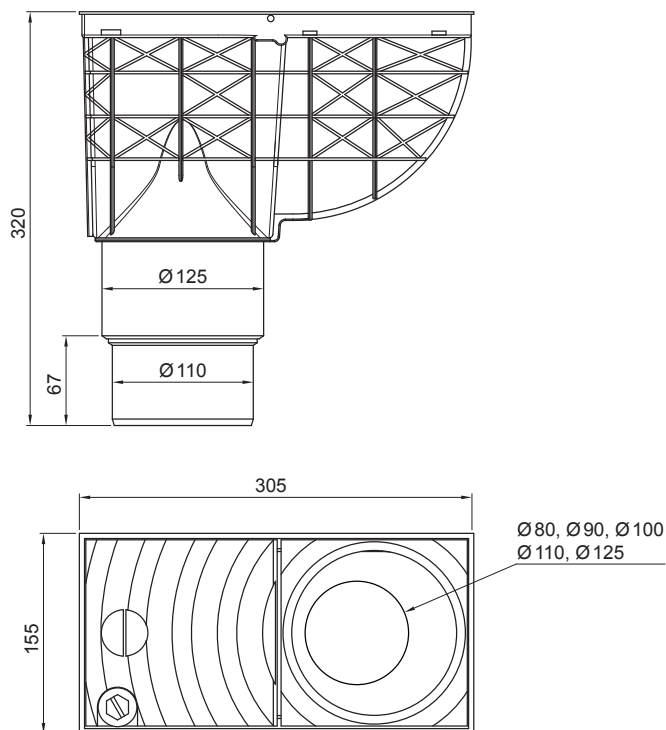

TECHNICKÝ LIST

KANALIZAČNÁ VPUŠŤ PRIAMA

SD-KV AGV4



PS PVC – Prachovo šedá – RAL 7037

INDEX	ZMENA	DATUM	PODPIS			
ZN. MAT.			T.O.			
ROZM.–POLOT						
POM. ZAR.				STN	TR.Č.	
VYPR.	Ing. Kluska M.			POZN.	Č.POZÍCIE	
PRESK.						
TECHNOL.	TECHNOL.			STARÝ V.	Č.V.	
NÁZOV	Kanalizačná vpusť priama			Počet listov	SD-KV AGV4	List 

Vytvorené: 21.04.2026 16:05:56

Technické zmeny vyhradené