



ODVODNI SISTEM POLUOKRUGLI



**CJENIK
2024**



POWERFUL PARTNER FOR YOUR ROOF



Aluminijski materijal | 4



Žlijeb | 6



Dilekacija žlijeba | 9



Žlijeb oprema | 13



Kuka | 15



Kutnik | 18



Čelo žlijeba | 20



Kotlić | 21



Koljeno | 32



Odvodna cijev | 35



Odvodna cijev oprema | 40



Obujmica | 42

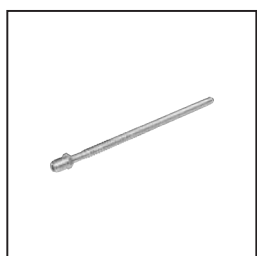

Obujmica oprema | 43



Zadržać vode | 45



Zaštitna cijev | 48

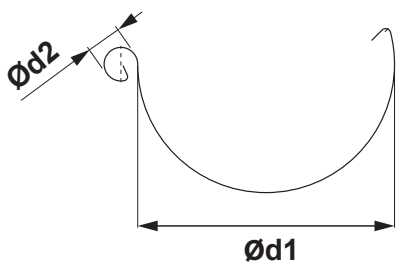

DIMENZIJE KROVNIH ŽLJEBOVA

(dimenzije i mjerne tolerancije po EN 612)

Razvijena širina (mm)	200	250	280	333	400
Ød1	80	105	127	153	192
Ød2	16	18	18	20	22

UNUTARNJI FALZ

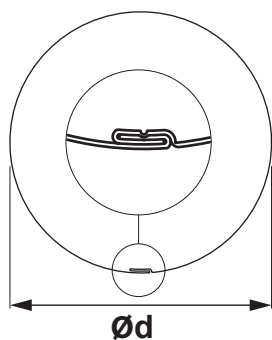

DIMENZIJE KROVNIH CIJEVI

(dimenzije i mjerne tolerancije po EN 612)

Dimenzije	60	80	100	120	150
Nazivna veličina Ød (mm)	60	80	100	120	150

DIMENZIJE KROVNIH KUKA

(dimenzije i mjerne tolerancije po EN 612)

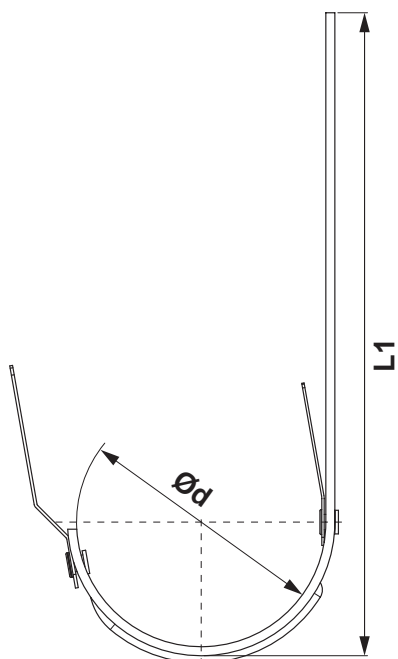

Dimenzije (mm)	L1	Ød
250	310	105
280	337	127
333 – 550	385	153
333 – 650	485	153
400	436	192

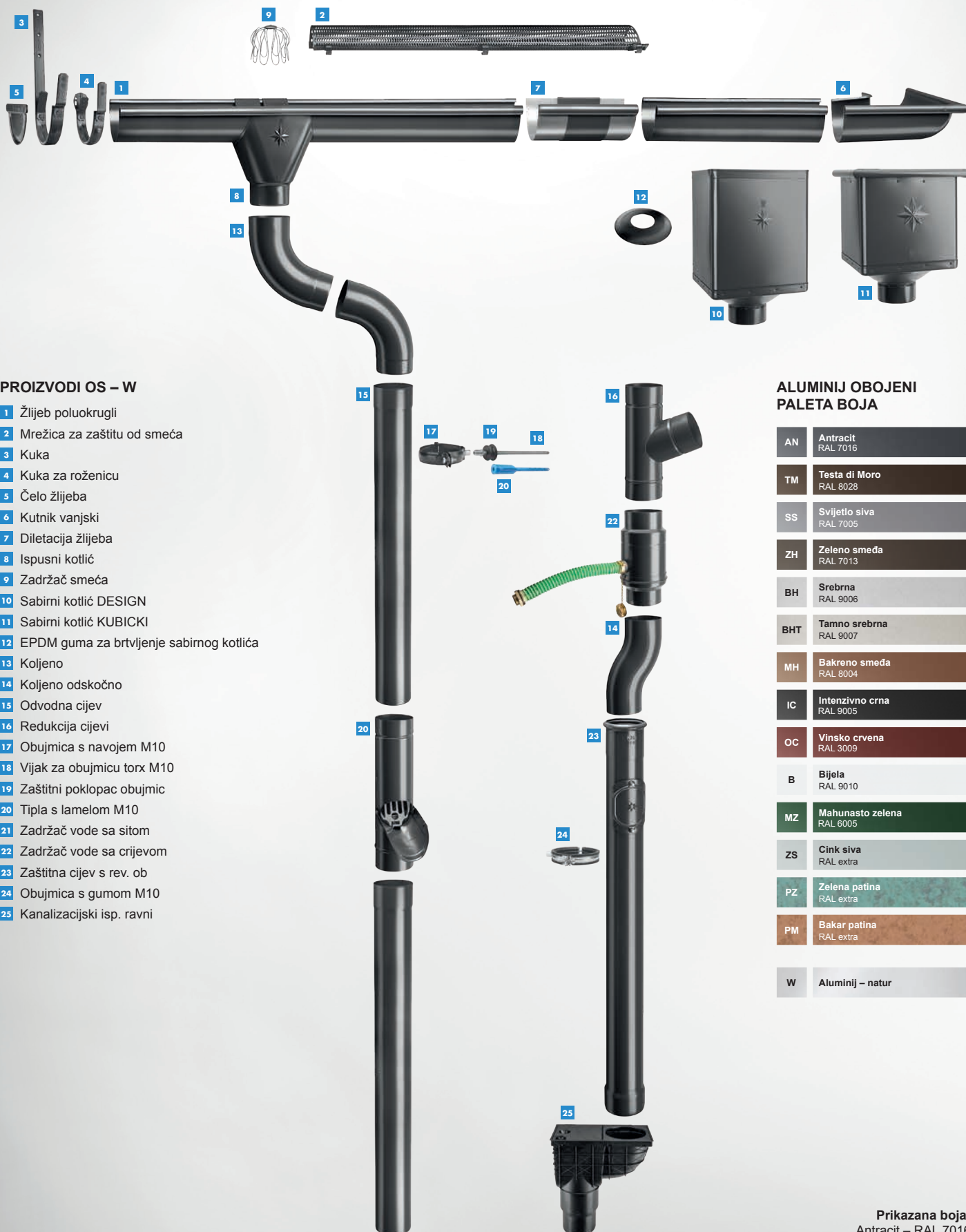

PROIZVODI OS – W

- 1 Žlijeb poluokrugli
- 2 Mrežica za zaštitu od smeća
- 3 Kuka
- 4 Kuka za roženicu
- 5 Čelo žlijeba
- 6 Kutnik vanjski
- 7 Diletacija žlijeba
- 8 Ispusni kotlić
- 9 Zadržlač smeća
- 10 Sabirni kotlić DESIGN
- 11 Sabirni kotlić KUBICKI
- 12 EPDM guma za brtvljenje sabirnog kotlića
- 13 Koljeno
- 14 Koljeno odskočno
- 15 Odvodna cijev
- 16 Redukcija cijevi
- 17 Obujmica s navojem M10
- 18 Vijak za obujmicu torx M10
- 19 Zaštitni poklopac obujmic
- 20 Tipla s lamelom M10
- 21 Zadržlač vode sa sitom
- 22 Zadržlač vode sa crijevom
- 23 Zaštitna cijev s rev. ob
- 24 Obujmica s gumom M10
- 25 Kanalizacijski isp. ravni

**ALUMINIJ OBOJENI
PALETA BOJA**

AN	Antracit RAL 7016
TM	Testa di Moro RAL 8028
SS	Svijetlo siva RAL 7005
ZH	Zeleno smeđa RAL 7013
BH	Srebrna RAL 9006
BHT	Tamno srebrna RAL 9007
MH	Bakreno smeđa RAL 8004
IC	Intenzivno crna RAL 9005
OC	Vinsko crvena RAL 3009
B	Bijela RAL 9010
MZ	Mahunasto zelena RAL 6005
ZS	Cink siva RAL extra
PZ	Zelena patina RAL extra
PM	Bakar patina RAL extra
W	Aluminij – natur



ALUMINIUM POLYESTER + NATUR

NOVELIS

Je američka industrijska aluminijska tvrtka sa sjedištem u Atlanti u državi Georgia u Sjedinjenim državama. Podružnica je indijskog proizvođača aluminija i bakra Hindalco Industries. Novelis je istaknuti proizvođač valjanog aluminija i globalni lider u recikliranju limenki od pića. Društvo pruža svojim klijentima usluge u industrijama kao što su limenke, automobilska industrija, potrošačka elektronika, građevinarstvo, folije i pakiranje.

ADITYA BIRLA



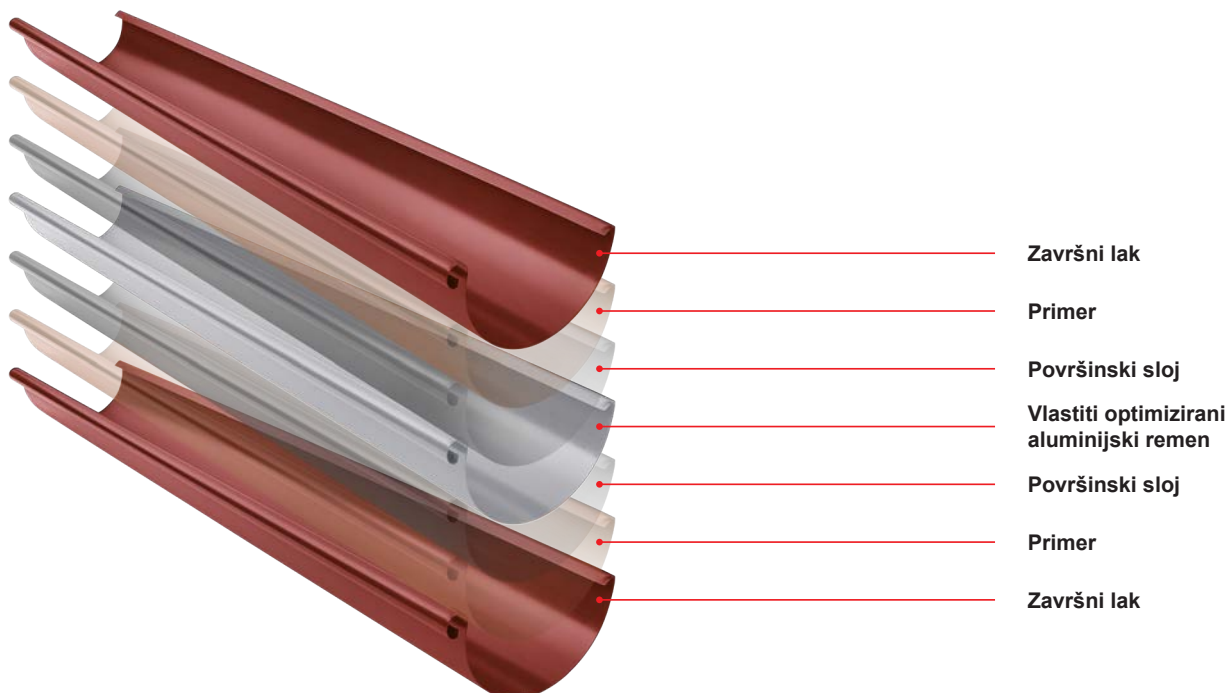

SPEIRA

Speira je globalna tvrtka za valjanje i recikliranje aluminija. Ima sedam tvornica i jedan centar za istraživanje i razvoj, koji se nalaze u Njemačkoj i Norveškoj, uključujući i našu zajedničku tvrtku Alunorf, najveću valjaonu aluminija na svijetu, kao i nekoliko međunarodnih prodajnih kancelarija. Speira zapošljava oko 5 000 ljudi posebice u Njemačkoj i Norveškoj.



ŽLIJEB POLUOKRUGLI [s=0,70]

W-WZ

Nominalna veličina	200		250		250		280		280		
	3,0		4,0		6,0		4,0		6,0		
Dužina u m	3,0		4,0		6,0		4,0		6,0		
Cijena u €/m	Bez PDV	S PDV	Bez PDV	S PDV	Bez PDV	S PDV	Bez PDV	S PDV	Bez PDV	S PDV	
AN Antracit RAL 7016	1	6,05	7,56	4,95	6,19	4,95	6,19	6,30	7,88	6,30	7,88
		051066 *		051073		051080		051097		051103	
TM Testa di Moro RAL 8028	2	6,05	7,56	4,95	6,19	4,95	6,19	6,30	7,88	6,30	7,88
		051707 *		051714		051721		051738		051745	
SS Svijetlo siva RAL 7005	3			4,95	6,19	4,95	6,19	6,30	7,88	6,30	7,88
				051639		051646		051653		051660	
ZH Zeleno smeđa RAL 7013	4			4,95	6,19	4,95	6,19	6,30	7,88	6,30	7,88
				051790		051806		051813		051820	
BH Srebrna RAL 9006	5			4,95	6,19	4,95	6,19	6,30	7,88	6,30	7,88
				051233		051240 *		051257		051264	
BHT Tamno srebrna RAL 9007	6			4,95	6,19	4,95	6,19	6,30	7,88	6,30	7,88
				101891 *		101907 *		101914 *		101921 *	
MH Bakreno smeđa RAL 8004	7			4,95	6,19	4,95	6,19	6,30	7,88	6,30	7,88
				051394		051400		051417		051424	
IC Intenzivno crna RAL 9005	8			4,95	6,19	4,95	6,19	6,30	7,88	6,30	7,88
				051318		051325 *		051332		051349 *	
OC Vinsko crvena RAL 3009	9			4,95	6,19	4,95	6,19	6,30	7,88	6,30	7,88
				051554		051561		051578		051585	
B Bijela RAL 9010	10			4,95	6,19	4,95	6,19	6,30	7,88	6,30	7,88
				051158		051165		051172		051189	
MZ Mahunasto zelena RAL 6005	11			4,95	6,19	4,95	6,19	6,30	7,88	6,30	7,88
				051479		051486		051493		051509	
ZS Cink siva RAL extra	12			4,95	6,19	4,95	6,19	6,30	7,88	6,30	7,88
				051875		051882 *		051899 *		051905 *	
PZ Zelena patina RAL extra	13										
PM Bakar patina RAL extra	14										
Aluminij Natur	15			4,70	5,88	4,70	5,88	5,40	6,75	5,40	6,75
				049957		049964		049971		049988	
Pak. u m 		15		20		30		20		30	
Pak. u m 		1 200		960		1 440		840		1 260	

* Proizvodnja po narudžbi



ŽLIJEB POLUOKRUGLI [s=0,70]

W-WZ



Nominalna veličina	333		333		400	
Dužina u m	4,0		6,0		6,0	
Cijena u €/m	Bez PDV	S PDV	Bez PDV	S PDV	Bez PDV	S PDV
AN 1 Antracit RAL 7016	6,45	8,06	6,45	8,06	9,40	11,75
	051110		051127		051134	
TM 2 Testa di Moro RAL 8028	6,45	8,06	6,45	8,06	9,40	11,75
	051752		051769		051776 *	
SS 3 Svijetlo siva RAL 7005	6,45	8,06	6,45	8,06	9,40	11,75
	051677		051684		051691	
ZH 4 Zeleno smeđa RAL 7013	6,45	8,06	6,45	8,06	9,40	11,75
	051837		051844		051851	
BH 5 Srebrna RAL 9006	6,45	8,06	6,45	8,06	9,40	11,75
	051271		051288		051295	
BHT 6 Tamno srebrna RAL 9007	6,45	8,06	6,45	8,06	9,40	11,75
	101938		101945		070104 *	
MH 7 Bakreno smeđa RAL 8004	6,45	8,06	6,45	8,06	9,40	11,75
	051431		051448		051455 *	
IC 8 Intenzivno crna RAL 9005	6,45	8,06	6,45	8,06	9,40	11,75
	051356		051363		051370 *	
OC 9 Vinsko crvena RAL 3009	6,45	8,06	6,45	8,06	9,40	11,75
	051592		051608		051615 *	
B 10 Bijela RAL 9010	6,45	8,06	6,45	8,06	9,40	11,75
	051196		051202		051219 *	
MZ 11 Mahunasto zelena RAL 6005	6,45	8,06	6,45	8,06	9,40	11,75
	051516		051523		051530	
ZS 12 Cink siva RAL extra	6,45	8,06	6,45	8,06	9,40	11,75
	051912		051929		051936 *	
PZ 13 Zelena patina RAL extra	9,00	11,25	9,00	11,25		
	112781 *		112798			
PM 14 Bakar patina RAL extra	9,00	11,25	9,00	11,25		
	112767 *		112774			
Aluminij 15 Natur	6,05	7,56	6,05	7,56	8,10	10,13
	049995		050007		050014	
Pak. u m 	20		30		30	
Pak. u m 	660		990		810	

* Proizvodnja po narudžbi



ŽLIJEB NATKROVNI [s=0,70]

W-WZS



Nominalna veličina	650		700		700	
Dužina u m	6,0		4,0		6,0	
Cijena u €/m	Bez PDV	S PDV	Bez PDV	S PDV	Bez PDV	S PDV
AN Antracit RAL 7016	1		23,00	28,75	23,00	28,75
			049193		049209	
TM Testa di Moro RAL 8028	2	17,10	21,38			
		049308 *				
SS Svijetlo siva RAL 7005	3		23,00	28,75	23,00	28,75
			049285 *		049292	
ZH Zeleno smeđa RAL 7013	4		23,00	28,75	23,00	28,75
			049315		049322	
BH Srebrna RAL 9006	5	17,10	21,38			
		049223 *				
BHT Tamno srebrna RAL 9007	6	17,10	21,38			
		101990 *				
MH Bakreno smeđa RAL 8004	7	17,10	21,38			
		049247 *				
IC Intenzivno crna RAL 9005	8	17,10	21,38			
		049230 *				
OC Vinsko crvena RAL 3009	9	17,10	21,38			
		049278 *				
B Bijela RAL 9010	10	17,10	21,38			
		049216 *				
MZ Mahunasto zelena RAL 6005	11		23,00	28,75	23,00	28,75
			049254		049261	
ZS Cink siva RAL extra	12	17,10	21,38			
		049339 *				
PZ Zelena patina RAL extra	13					
PM Bakar patina RAL extra	14					
Aluminij Natur	15	15,50	19,38			
		049186 *				
Pak. u m 		6		4		6
Pak. u m 		300		200		300

* Proizvodnja po narudžbi



STREŠNÝ DILATAČNÝ ŽLAB POLKRUHOVÝ

W-WZDI

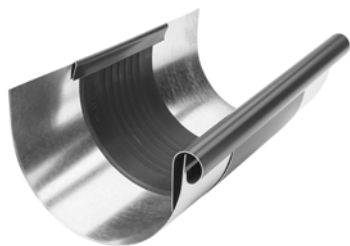

Nominalna veličina	250/260		285/260		333/260		400/260	
	Bez PDV	S PDV	Bez PDV	S PDV	Bez PDV	S PDV	Bez PDV	S PDV
AN 1 Antracit RAL 7016	20,50	25,63	21,50	26,88	21,50	26,88	27,00	33,75
	028341 *		028358 *		028365		028372	
TM 2 Testa di Moro RAL 8028	20,50	25,63	21,50	26,88	21,50	26,88	27,00	33,75
	028662 *		028679 *		028686		028693 *	
SS 3 Svijetlo siva RAL 7005	20,50	25,63	21,50	26,88	21,50	26,88	27,00	33,75
	028624 *		028631 *		028648 *		028655 *	
ZH 4 Zeleno smeđa RAL 7013	20,50	25,63	21,50	26,88	21,50	26,88	27,00	33,75
	028709 *		028716 *		028723 *		028730 *	
BH 5 Srebrna RAL 9006	20,50	25,63	21,50	26,88	21,50	26,88	27,00	33,75
	028426 *		028433 *		028440		028457	
BHT 6 Tamno srebrna RAL 9007	20,50	25,63	21,50	26,88	21,50	26,88	27,00	33,75
	101440 *		101457 *		101464 *		070135 *	
MH 7 Bakreno smeđa RAL 8004	20,50	25,63	21,50	26,88	21,50	26,88	27,00	33,75
	028501 *		028518 *		028525 *		028532 *	
IC 8 Intenzivno crna RAL 9005	20,50	25,63	21,50	26,88	21,50	26,88	27,00	33,75
	028464 *		028471 *		028488 *		028495 *	
OC 9 Vinsko crvena RAL 3009	20,50	25,63	21,50	26,88	21,50	26,88	27,00	33,75
	028587 *		028594 *		028600 *		028617 *	
B 10 Bijela RAL 9010	20,50	25,63	21,50	26,88	21,50	26,88	27,00	33,75
	028389 *		028396 *		028402 *		028419 *	
MZ 11 Mahunasto zelena RAL 6005	20,50	25,63	21,50	26,88	21,50	26,88	27,00	33,75
	028549 *		028556 *		028563 *		028570 *	
ZS 12 Cink siva RAL extra	20,50	25,63	21,50	26,88	21,50	26,88	27,00	33,75
	028747 *		028754 *		028761 *		028778 *	
PZ 13 Zelena patina RAL extra					32,50	40,63		
					112590 *			
PM 14 Bakar patina RAL extra					32,50	40,63		
					112583 *			
Aluminij 15 Natur	22,70	28,38	23,60	29,50	25,50	31,88	31,70	39,63
	028303 *		028310 *		028327 *		028334 *	
Pak. u kom 	3		3		5		5	
Pak. u kom 	360		360		200		200	

* Proizvodnja po narudžbi



DILETACIJA ZA LEŽEĆI ŽLIJEB

W-WZSDI

Nominalna veličina	670/260	
Cijena u €/kom	Bez PDV	S PDV
AN 1 Antracit RAL 7016	65,00	81,25
		029157 *
TM 2 Testa di Moro RAL 8028	65,00	81,25
		029232 *
SS 3 Svijetlo siva RAL 7005	65,00	81,25
		029225 *
ZH 4 Zeleno smeđa RAL 7013	65,00	81,25
		029249 *
BH 5 Srebrna RAL 9006	65,00	81,25
		029171 *
BHT 6 Tamno srebrna RAL 9007	65,00	81,25
		101471 *
MH 7 Bakreno smeđa RAL 8004	65,00	81,25
		029195 *
IC 8 Intenzivno crna RAL 9005	65,00	81,25
		029188 *
OC 9 Vinsko crvena RAL 3009	65,00	81,25
		029218 *
B 10 Bijela RAL 9010	65,00	81,25
		029164 *
MZ 11 Mahunasto zelena RAL 6005	65,00	81,25
		029201 *
ZS 12 Cink siva RAL extra	65,00	81,25
		029256 *
PZ 13 Zelena patina RAL extra		
PM 14 Bakar patina RAL extra		
Aluminij 15 Natur	58,50	73,13
		029140 *
Pak. u kom 		1
Pak. u kom 		40



* Proizvodnja po narudžbi





DILETACIJSKA TRAKA

W-WZDIP

Nominalna veličina	Dužina u m	EAN broj narudžbe	Pakiranje u m		Cijena [€/m]	
					Bez PDV	S PDV
260	3,0	028181	3	120	40,00	50,00

KORIŠTENJE SPOJKE ŽLIJEBA I SPOJNE TRAKE

SPOJKA ŽLIJEBA

Primjer montaže: Podkorvni žlijeb razvijene širine do 500 mm. Spojka žlijeba mora biti montirana u međusobnoj udaljenosti 15 m. Za vanjski kutnik i početak žlijeba važi polovica standardne vrijednosti: maksimalno 7,5 m. Za unutarnji kutnik važi četvrtina standardne vrijednosti: maksimalno 3,75 m. Za ostale materijale i dimenzije: vidi tabelica dolje. Kutnici se uvijek smatraju čvrstim točkama.

KROVNI POLUOKRUGLI ŽLJEBOVI

Razvijena širina žlijeba	Aluminij	Pocink, Cinkotit, Bakar, Inox
< 500	12	15
> 500	8	10

SPAJANJE TRAKOM

Unutarnja instalacija: za četvrtaste žljebove pričvršćene za podlogu bez lijepljenja, za krovove s nestandardnim profilom, i oplatu zida limom

KROVNO SPAJANJE TRAKOM

Razvijena širina žlijeba	Aluminij	Pocink, Cinkotit, Bakar, Inox
< 500	8	10
> 500	6	8

Za vanjski kutnik ili početak žlijeba važi polovica standardne vrijednosti. Za unutarnji kutnik važi četvrtina standardne vrijednosti.

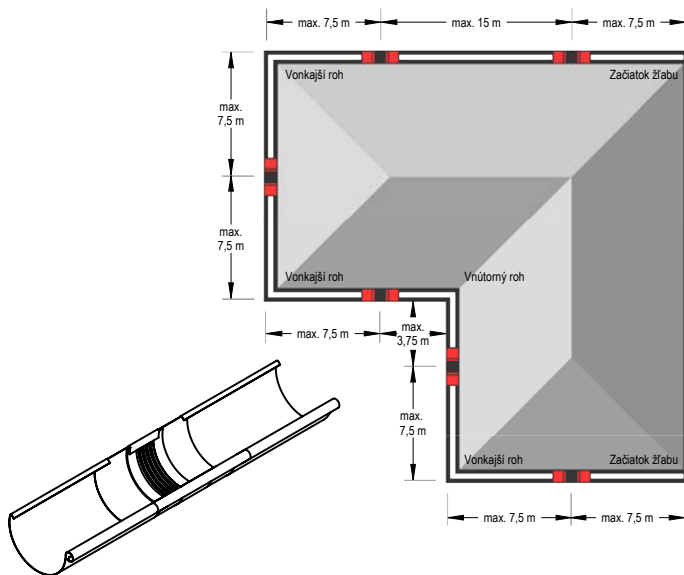

Napomena uz montažu spojne trake.

Za vrijeme montaže uz pomoć mekog lemljenja prvo pokrite dio mokrom krpom (kako ne bi došlo do prelaska topline u središnji gumeni dio). Mora se održavati minimalna udaljenost 6 cm od središnjeg gumenog dijela. U svakom slučaju treba izbjegavati kontakt gume s plamenom.

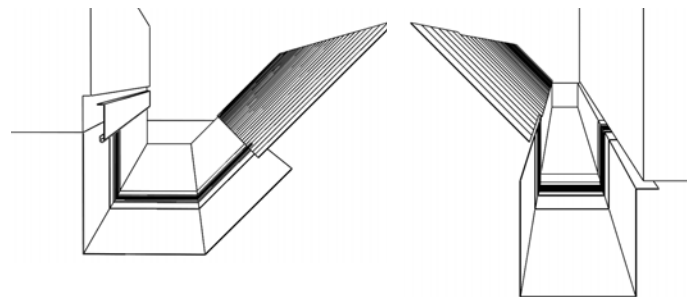



Napomena uz montažu spojne trake.

Kada se savija i montira spojna traka, provjerite sljedeće:

- Kliješta za savijanje imaju radijus minimalno 2 mm.
- Za debljinu lima 1 mm se mora održati polumjer savijanja minimalno 5 mm.
- Kliješta za savijanje moraju za vrijeme savijanja biti podešena za debljinu 3 do 4 mm, kako bi se spriječio efekt sječenja – oštećenja gume.
- Središnji gumeni dio za vrijeme savijanja ne smije biti pritisnut ili oštećen. Treba zbog toga koristiti aluminijsku limenu traku debljine 2 do 5 mm, i saviti je tako, da se može pričvrstiti kao zaštita za kliješta za savijanje. Time ćemo dobiti veći polumjer savijanja, i spriječiti da se ošteti središnji gumeni dio.

MRIEŽKA ZACHYTÁVAČA NEČISTÔT

W-WZNLM

Nominalna veličina	333	
Dužina u m	2,0	
Cijena u €/kom	Bez PDV	S PDV
AN 1 Antracit RAL 7016	26,50	33,13
	064950	
TM 2 Testa di Moro RAL 8028	26,50	33,13
	064981 *	
SS 3 Svijetlo siva RAL 7005	26,50	33,13
	064974	
ZH 4 Zeleno smeđa RAL 7013	26,50	33,13
	118127 *	
BH 5 Srebrna RAL 9006	26,50	33,13
	118080 *	
BHT 6 Tamno srebrna RAL 9007	26,50	33,13
	118097 *	
MH 7 Bakreno smeđa RAL 8004	26,50	33,13
	118103 *	
IC 8 Intenzivno crna RAL 9005	26,50	33,13
	118059	
OC 9 Vinsko crvena RAL 3009	26,50	33,13
	118066 *	
B 10 Bijela RAL 9010	26,50	33,13
	118134 *	
MZ 11 Mahunasto zelena RAL 6005	26,50	33,13
	118110 *	
ZS 12 Cink siva RAL extra	26,50	33,13
	118073 *	
PZ 13 Zelena patina RAL extra		
PM 14 Bakar patina RAL extra		
Aluminij 15 Natur	25,50	31,88
	064905	
Pak. u kom 	15	
Pak. u kom 	120	

* Proizvodnja po narudžbi

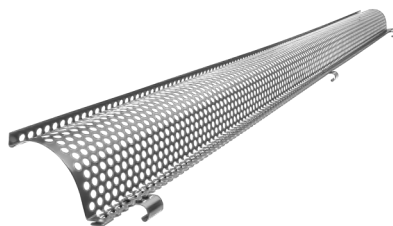



ALUMINIUM POLYESTER + NATUR

PVC ŽLIJEJNI ZADRŽAČ SMEĆA

SD-ZNL MRIEZKA

Nominalna veličina	Dužina u m	EAN broj narudžbe	Pakiranje u kom		Cijena [€/kom]	
					Bez PDV	S PDV
PS 171	1,0	008473	30	450	4,50	5,63
TM 171	1,0	008466	30	450	4,50	5,63

PVC ŽLIJEJNI ZADRŽAČ SMEĆA

SD-ZNL N

Nominalna veličina	Dužina u m	EAN broj narudžbe	Pakiranje u kom		Cijena [€/kom]	
					Bez PDV	S PDV
250	3,0	008480	10	400	23,90	29,88
280-333	3,0	008497	10	400	24,00	30,00

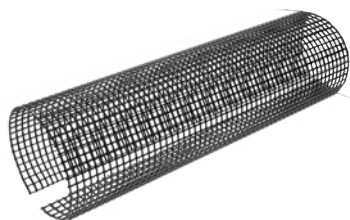
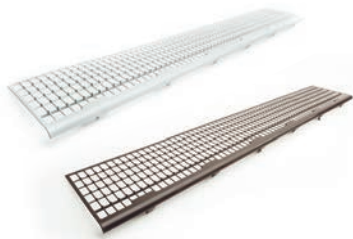

STREŠNÝ KUKA S PRELISOM
W-WHP

Nominalna veličina	250/430		280/480		333/550		333/650		400/650		
Materijal	23/7		28/7		28/7		28/7		30/7		
Cijena u €/kom	Bez PDV	S PDV	Bez PDV	S PDV	Bez PDV	S PDV	Bez PDV	S PDV	Bez PDV	S PDV	
AN Antracit RAL 7016	1	3,40	4,25	3,90	4,88	4,30	5,38	4,90	6,13	5,20	6,50
		077615		077622		077639		077646		077653	
TM Testa di Moro RAL 8028	2	3,40	4,25	3,90	4,88	4,30	5,38	4,90	6,13	5,20	6,50
		078018		078025		078032		078049		078056	
SS Svijetlo siva RAL 7005	3	3,40	4,25	3,90	4,88	4,30	5,38	4,90	6,13	5,20	6,50
		077967		077974		077981		077998		078001	
ZH Zeleno smeđa RAL 7013	4	3,40	4,25	3,90	4,88	4,30	5,38	4,90	6,13	5,20	6,50
		078063		078070		078117		078087		078094	
BH Srebrna RAL 9006	5	3,40	4,25	3,90	4,88	4,30	5,38	4,90	6,13	5,20	6,50
		077714		077738		077721		077745 *		077752	
BHT Tamno srebrna RAL 9007	6	3,40	4,25	3,90	4,88	4,30	5,38	4,90	6,13	5,20	6,50
		101488 *		101495 *		101501		101518 *		080264 *	
MH Bakreno smeđa RAL 8004	7	3,40	4,25	3,90	4,88	4,30	5,38	4,90	6,13	5,20	6,50
		077813		077820		077837		077844 *		077851	
IC Intenzivno crna RAL 9005	8	3,40	4,25	3,90	4,88	4,30	5,38	4,90	6,13	5,20	6,50
		077769		077776		077783		077790 *		077806	
OC Vinsko crvena RAL 3009	9	3,40	4,25	3,90	4,88	4,30	5,38	4,90	6,13	5,20	6,50
		077912		077929		077936		077943 *		077950	
B Bijela RAL 9010	10	3,40	4,25	3,90	4,88	4,30	5,38	4,90	6,13	5,20	6,50
		077660		077677		077684		077691 *		077707	
MZ Mahunasto zelena RAL 6005	11	3,40	4,25	3,90	4,88	4,30	5,38	4,90	6,13	5,20	6,50
		077868		077899		077875		077882		077905	
ZS Cink siva RAL extra	12	3,40	4,25	3,90	4,88	4,30	5,38	4,90	6,13	5,20	6,50
		078124		078100		078131		078148 *		078155 *	
PZ Zelena patina RAL extra	13					9,00	11,25				
						112613					
PM Bakar patina RAL extra	14					9,00	11,25				
						112606					
Aluminij Natur	15	3,05	3,81	3,50	4,38	3,85	4,81	4,40	5,50	4,70	5,88
		011930		011947		077585		077592		077608	
Pak. u kom		25		25		25		15		20	
Pak. u kom		1 000		1 000		1 000		600		800	

* Proizvodnja po narudžbi



STREŠNÝ KUKA KROKVA

W-WHPK



Nominalna veličina	250		280		333	
Materjal	28/7		28/7		28/7	
Cijena u €/kom	Bez PDV	S PDV	Bez PDV	S PDV	Bez PDV	S PDV
AN 1 Antracit RAL 7016	3,85	4,81	3,90	4,88	3,95	4,94
	011596		011602		011619	
TM 2 Testa di Moro RAL 8028	3,85	4,81	3,90	4,88	3,95	4,94
	011831		011848		011855	
SS 3 Svijetlo siva RAL 7005	3,85	4,81	3,90	4,88	3,95	4,94
	011800		011817 *		011824	
ZH 4 Zeleno smeđa RAL 7013	3,85	4,81	3,90	4,88	3,95	4,94
	011862		011879		011886	
BH 5 Srebrna RAL 9006	3,85	4,81	3,90	4,88	3,95	4,94
	011657		011664		011671	
BHT 6 Tamno srebrna RAL 9007	3,85	4,81	3,90	4,88	3,95	4,94
	101402 *		101396 *		101389 *	
MH 7 Bakreno smeđa RAL 8004	3,85	4,81	3,90	4,88	3,95	4,94
	011718		011725 *		011732	
IC 8 Intenzivno crna RAL 9005	3,85	4,81	3,90	4,88	3,95	4,94
	011688		011695 *		011701	
OC 9 Vinsko crvena RAL 3009	3,85	4,81	3,90	4,88	3,95	4,94
	011770 *		011787 *		011794	
B 10 Bijela RAL 9010	3,85	4,81	3,90	4,88	3,95	4,94
	011626		011633		011640	
MZ 11 Mahunasto zelena RAL 6005	3,85	4,81	3,90	4,88	3,95	4,94
	011749		011756		011763	
ZS 12 Cink siva RAL extra	3,85	4,81	3,90	4,88	3,95	4,94
	011893 *		011909 *		011916 *	
PZ 13 Zelena patina RAL extra						
PM 14 Bakar patina RAL extra						
Aluminij 15 Natur	3,45	4,31	3,50	4,38	3,55	4,44
	011565		011572		011589	
Pak. u kom	25		25		25	
Pak. u kom	1 000		1 000		1 000	

* Proizvodnja po narudžbi



KUKA ZA NATKROVNI ŽLIJEBSPEVNENÝ

W-WHSG



Nominalna veličina	4	
Materjal	28/7	
Cijena u €/kom	Bez PDV	S PDV
AN 1 Antracit RAL 7016	8,95	11,19
		034113
TM 2 Testa di Moro RAL 8028	8,95	11,19
		034199 *
SS 3 Svijetlo siva RAL 7005	8,95	11,19
		034182
ZH 4 Zeleno smeđa RAL 7013	8,95	11,19
		034205
BH 5 Srebrna RAL 9006	8,95	11,19
		034137
BHT 6 Tamno srebrna RAL 9007	8,95	11,19
		101525 *
MH 7 Bakreno smeđa RAL 8004	8,95	11,19
		034151
IC 8 Intenzivno crna RAL 9005	8,95	11,19
		034144 *
OC 9 Vinsko crvena RAL 3009	8,95	11,19
		034175 *
B 10 Bijela RAL 9010	8,95	11,19
		034120 *
MZ 11 Mahunasto zelena RAL 6005	8,95	11,19
		034168
ZS 12 Cink siva RAL extra	8,95	11,19
		034212 *
PZ 13 Zelena patina RAL extra		
PM 14 Bakar patina RAL extra		
Aluminij 15 Natur	8,05	10,06
		034229 *
Pak. u kom 	15	
Pak. u kom 	600	

* Proizvodnja po narudžbi



KUTNIK VANJSKI

W-WRA



Nominalna veličina	200		250		280		333		400	
	Bez PDV	S PDV	Bez PDV	S PDV	Bez PDV	S PDV	Bez PDV	S PDV	Bez PDV	S PDV
AN 1 Antracit RAL 7016			14,80	18,50	15,50	19,38	16,20	20,25	29,00	36,25
				082220		082237		082244		082251
TM 2 Testa di Moro RAL 8028			14,80	18,50	15,50	19,38	16,20	20,25	29,00	36,25
				082541		082558		082565		082572 *
SS 3 Svijetlo siva RAL 7005			14,80	18,50	15,50	19,38	16,20	20,25	29,00	36,25
				082503		082510		082527		082534
ZH 4 Zeleno smeđa RAL 7013			14,80	18,50	15,50	19,38	16,20	20,25	29,00	36,25
				082589		082596		082602		082619 *
BH 5 Srebrna RAL 9006			14,80	18,50	15,50	19,38	16,20	20,25	29,00	36,25
				082305		082312 *		082329		082336 *
BHT 6 Tamno srebrna RAL 9007			14,80	18,50	15,50	19,38	16,20	20,25	29,00	36,25
				101839 *		101846 *		101853		080295 *
MH 7 Bakreno smeđa RAL 8004			14,80	18,50	15,50	19,38	16,20	20,25	29,00	36,25
				082381		082398		082404		082411 *
IC 8 Intenzivno crna RAL 9005			14,80	18,50	15,50	19,38	16,20	20,25	29,00	36,25
				082343		082350		082367		082374 *
OC 9 Vinsko crvena RAL 3009			14,80	18,50	15,50	19,38	16,20	20,25	29,00	36,25
				082466		082473		082480		082497 *
B 10 Bijela RAL 9010			14,80	18,50	15,50	19,38	16,20	20,25	29,00	36,25
				082268		082275		082282		082299 *
MZ 11 Mahunasto zelena RAL 6005			14,80	18,50	15,50	19,38	16,20	20,25	29,00	36,25
				082428		082435		082442		082459 *
ZS 12 Cink siva RAL extra			14,80	18,50	15,50	19,38	16,20	20,25	29,00	36,25
				082626		082633		082640		082657 *
PZ 13 Zelena patina RAL extra							17,70	22,13		
								112736		
PM 14 Bakar patina RAL extra							17,70	22,13		
								112729		
Aluminij 15 Natur	13,30	16,63	13,30	16,63	13,95	17,44	14,60	18,25	26,10	32,63
				000514 *		000521		000538		000545
								000545		000552 *
Pak. u kom 	5		5		5		5		5	
Pak. u kom 	150		150		150		150		150	

* Proizvodnja po narudžbi



KUTNIK UNUTARNJI

W-WRI

Nominalna veličina	200		250		280		333		400	
	Bez PDV	S PDV	Bez PDV	S PDV	Bez PDV	S PDV	Bez PDV	S PDV	Bez PDV	S PDV
AN 1 Antracit RAL 7016			14,80	18,50	15,50	19,38	16,20	20,25	29,00	36,25
			081780		081797		081803		081810	
TM 2 Testa di Moro RAL 8028			14,80	18,50	15,50	19,38	16,20	20,25	29,00	36,25
			082107		082114		082121		082138	
SS 3 Svijetlo siva RAL 7005			14,80	18,50	15,50	19,38	16,20	20,25	29,00	36,25
			082060		082077		082084		082091 *	
ZH 4 Zeleno smeđa RAL 7013			14,80	18,50	15,50	19,38	16,20	20,25	29,00	36,25
			082145		082152		082169		082176 *	
BH 5 Srebrna RAL 9006			14,80	18,50	15,50	19,38	16,20	20,25	29,00	36,25
			081865 *		081872 *		081889		081896 *	
BHT 6 Tamno srebrna RAL 9007			14,80	18,50	15,50	19,38	16,20	20,25	29,00	36,25
			101860 *		101877 *		101884		069221 *	
MH 7 Bakreno smeđa RAL 8004			14,80	18,50	15,50	19,38	16,20	20,25	29,00	36,25
			081940		081957		081964		081971 *	
IC 8 Intenzivno crna RAL 9005			14,80	18,50	15,50	19,38	16,20	20,25	29,00	36,25
			081902		081919		081926		081933 *	
OC 9 Vinsko crvena RAL 3009			14,80	18,50	15,50	19,38	16,20	20,25	29,00	36,25
			082022		082039		082046		082053 *	
B 10 Bijela RAL 9010			14,80	18,50	15,50	19,38	16,20	20,25	29,00	36,25
			081827		081834		081841		081858 *	
MZ 11 Mahunasto zelena RAL 6005			14,80	18,50	15,50	19,38	16,20	20,25	29,00	36,25
			081988		081995		082008		082015 *	
ZS 12 Cink siva RAL extra			14,80	18,50	15,50	19,38	16,20	20,25	29,00	36,25
			082183		082190		082206		082213 *	
PZ 13 Zelena patina RAL extra							17,70	22,13		
							112750			
PM 14 Bakar patina RAL extra							17,70	22,13		
							112743			
Aluminij 15 Natur	13,30	16,63	13,30	16,63	13,95	17,44	14,60	18,25	26,10	32,63
	000569 *		000576 *		000583 *		000590 *		000606 *	
Pak. u kom 	5		5		5		5		5	
Pak. u kom 	150		150		150		150		150	

* Proizvodnja po narudžbi



ČELO ŽLIJEBA

W-WCL



Nominalna veličina	200		250		280		333		400	
	Bez PDV	S PDV	Bez PDV	S PDV	Bez PDV	S PDV	Bez PDV	S PDV	Bez PDV	S PDV
AN 1 Antracit RAL 7016	1,50	1,88	1,50	1,88	1,55	1,94	1,60	2,00	2,40	3,00
	085856 *		085863		085870		085887		085894	
TM 2 Testa di Moro RAL 8028	1,50	1,88	1,50	1,88	1,55	1,94	1,60	2,00	2,40	3,00
	086228 *		086235		086242		086259		086266	
SS 3 Svijetlo siva RAL 7005			1,50	1,88	1,55	1,94	1,60	2,00	2,40	3,00
			086181		086198		086204		086211	
ZH 4 Zeleno smeđa RAL 7013			1,50	1,88	1,55	1,94	1,60	2,00	2,40	3,00
			086273		086280		086297		086303	
BH 5 Srebrna RAL 9006			1,50	1,88	1,55	1,94	1,60	2,00	2,40	3,00
			085948		085955		085962		085979	
BHT 6 Tamno srebrna RAL 9007			1,50	1,88	1,55	1,94	1,60	2,00	2,40	3,00
			101419 *		101426 *		101433		080257 *	
MH 7 Bakreno smeđa RAL 8004			1,50	1,88	1,55	1,94	1,60	2,00	2,40	3,00
			086020		086037		086044		086051	
IC 8 Intenzivno crna RAL 9005			1,50	1,88	1,55	1,94	1,60	2,00	2,40	3,00
			085986		085993		086006		086013 *	
OC 9 Vinsko crvena RAL 3009			1,50	1,88	1,55	1,94	1,60	2,00	2,40	3,00
			086105		086112		086129		086136	
B 10 Bijela RAL 9010			1,50	1,88	1,55	1,94	1,60	2,00	2,40	3,00
			085900		085917		085924		085931 *	
MZ 11 Mahunasto zelena RAL 6005			1,50	1,88	1,55	1,94	1,60	2,00	2,40	3,00
			086068		086075		086082		086099 *	
ZS 12 Cink siva RAL extra			1,50	1,88	1,55	1,94	1,60	2,00	2,40	3,00
			086310		086327 *		086334		086341 *	
PZ 13 Zelena patina RAL extra							4,00	5,00		
							086174			
PM 14 Bakar patina RAL extra							4,00	5,00		
							086150			
Aluminij 15 Natur			1,35	1,69	1,40	1,75	1,45	1,81	2,15	2,69
			085818		085825		085832		085849	
Pak. u kom 	6/60		6/60		6/60		6/60		4/40	
Pak. u kom 	1 440		1 440		1 440		1 440		960	

* Proizvodnja po narudžbi



ŽLABOVÝ KOTLÍK

W-WKL



Nominalna veličina	200/60		250/60		250/80		280/80		280/100	
	Bez PDV	S PDV	Bez PDV	S PDV	Bez PDV	S PDV	Bez PDV	S PDV	Bez PDV	S PDV
AN 1 Antracit RAL 7016	10,00	12,50	10,60	13,25	11,30	14,13	13,00	16,25	12,50	15,63
	078278		078285		078292		078308		078315	
TM 2 Testa di Moro RAL 8028	10,00	12,50	10,60	13,25	11,30	14,13	13,00	16,25	12,50	15,63
	079152		079169		079176		079183		079190	
SS 3 Svijetlo siva RAL 7005	10,00	12,50	10,60	13,25	11,30	14,13	13,00	16,25	12,50	15,63
	079046 *		079053 *		079060		079077		079084	
ZH 4 Zeleno smeđa RAL 7013	10,00	12,50	10,60	13,25	11,30	14,13	13,00	16,25	12,50	15,63
	079268 *		079275		079282		079299		079305	
BH 5 Srebrna RAL 9006	10,00	12,50	10,60	13,25	11,30	14,13	13,00	16,25	12,50	15,63
	078490 *		078506 *		078513		078520		078537	
BHT 6 Tamno srebrna RAL 9007					11,30	14,13	13,00	16,25	12,50	15,63
					101594		101600 *		101617 *	
MH 7 Bakreno smeđa RAL 8004	10,00	12,50	10,60	13,25	11,30	14,13	13,00	16,25	12,50	15,63
	078711 *		078728 *		078735		078742		078759	
IC 8 Intenzivno crna RAL 9005	10,00	12,50	10,60	13,25	11,30	14,13	13,00	16,25	12,50	15,63
	078605 *		078612 *		078629		078636		078643	
OC 9 Vinsko crvena RAL 3009	10,00	12,50	10,60	13,25	11,30	14,13	13,00	16,25	12,50	15,63
	078964 *		078933 *		078940		078957		078971	
B 10 Bijela RAL 9010	10,00	12,50	10,60	13,25	11,30	14,13	13,00	16,25	12,50	15,63
	078384 *		078391 *		078407		078414		078421	
MZ 11 Mahunasto zelena RAL 6005	10,00	12,50	10,60	13,25	11,30	14,13	13,00	16,25	12,50	15,63
	078827 *		078834 *		078841		078858		078865	
ZS 12 Cink siva RAL extra	10,00	12,50	10,60	13,25	11,30	14,13	13,00	16,25	12,50	15,63
	079374 *		079381 *		079398		079404		079411	
PZ 13 Zelena patina RAL extra										
PM 14 Bakar patina RAL extra										
Aluminij 15 Natur	9,00	11,25	9,55	11,94	10,20	12,75	11,70	14,63	11,25	14,06
	078162 *		078179 *		078186		078193		078223	
Pak. u kom 	20		20		20		20		20	
Pak. u kom 	600		600		600		600		600	

* Proizvodnja po narudžbi



ŽLABOVÝ KOTLÍK

W-WKL



Nominalna veličina	333/80		333/100		333/120	
	Bez PDV	S PDV	Bez PDV	S PDV	Bez PDV	S PDV
AN 1 Antracit RAL 7016	13,40	16,75	13,70	17,13	18,00	22,50
	078322		078339		078346	
TM 2 Testa di Moro RAL 8028	13,40	16,75	13,70	17,13	18,00	22,50
	079206		079213		079220	
SS 3 Svijetlo siva RAL 7005	13,40	16,75	13,70	17,13	18,00	22,50
	079091 *		079107		079114	
ZH 4 Zeleno smeđa RAL 7013	13,40	16,75	13,70	17,13	18,00	22,50
	079312 *		079336		079329	
BH 5 Srebrna RAL 9006	13,40	16,75	13,70	17,13	18,00	22,50
	078544		078551		078568	
BHT 6 Tamno srebrna RAL 9007	13,40	16,75	13,70	17,13	18,00	22,50
	101624 *		101631		101648 *	
MH 7 Bakreno smeđa RAL 8004	13,40	16,75	13,70	17,13	18,00	22,50
	078766 *		078773		078780	
IC 8 Intenzivno crna RAL 9005	13,40	16,75	13,70	17,13	18,00	22,50
	078650 *		078667		078674	
OC 9 Vinsko crvena RAL 3009	13,40	16,75	13,70	17,13	18,00	22,50
	078988 *		078995		079015	
B 10 Bijela RAL 9010	13,40	16,75	13,70	17,13	18,00	22,50
	078438		078445		078452	
MZ 11 Mahunasto zelena RAL 6005	13,40	16,75	13,70	17,13	18,00	22,50
	078872 *		078889		078896	
ZS 12 Cink siva RAL extra	13,40	16,75	13,70	17,13	18,00	22,50
	079428 *		079435		079442	
PZ 13 Zelena patina RAL extra			19,20	24,00		
			112675			
PM 14 Bakar patina RAL extra			19,20	24,00		
			112668			
Aluminij 15 Natur	12,05	15,06	12,35	15,44	16,20	20,25
	078209		078230		078216	
Pak. u kom 	20		20		15	
Pak. u kom 	600		600		300	

* Proizvodnja po narudžbi



ŽLABOVÝ KOTLÍK

W-WKL

Nominalna veličina	400/100		400/120		400/150	
	Bez PDV	S PDV	Bez PDV	S PDV	Bez PDV	S PDV
AN 1 Antracit RAL 7016	18,70	23,38	20,00	25,00	35,00	43,75
	078353 *		078360		078377 *	
TM 2 Testa di Moro RAL 8028	18,70	23,38	20,00	25,00	35,00	43,75
	079237 *		079244		079251 *	
SS 3 Svijetlo siva RAL 7005	18,70	23,38	20,00	25,00	35,00	43,75
	079121 *		079138		079145 *	
ZH 4 Zeleno smeđa RAL 7013	18,70	23,38	20,00	25,00	35,00	43,75
	079343 *		079350		079367	
BH 5 Srebrna RAL 9006	18,70	23,38	20,00	25,00	35,00	43,75
	078575 *		078582		078599 *	
BHT 6 Tamno srebrna RAL 9007			20,00	25,00		
			080288 *			
MH 7 Bakreno smeđa RAL 8004	18,70	23,38	20,00	25,00	35,00	43,75
	078797 *		078803		078810 *	
IC 8 Intenzivno crna RAL 9005	18,70	23,38	20,00	25,00	35,00	43,75
	078681 *		078698		078704 *	
OC 9 Vinsko crvena RAL 3009	18,70	23,38	20,00	25,00	35,00	43,75
	079008 *		079022 *		079039 *	
B 10 Bijela RAL 9010	18,70	23,38	20,00	25,00	35,00	43,75
	078469 *		078476		078483 *	
MZ 11 Mahunasto zelena RAL 6005	18,70	23,38	20,00	25,00	35,00	43,75
	078902 *		078919		078926 *	
ZS 12 Cink siva RAL extra	18,70	23,38	20,00	25,00	35,00	43,75
	079459 *		079466		079473 *	
PZ 13 Zelena patina RAL extra						
PM 14 Bakar patina RAL extra						
Aluminij 15 Natur	16,85	21,06	18,00	22,50	31,50	39,38
	078247 *		078254		078261 *	
Pak. u kom 	15		15		15	
Pak. u kom 	300		300		300	

* Proizvodnja po narudžbi



NOVI PRIČVRŠNI
SISTEM FEDER OMOGUĆUJE
LAGANO OKRETANJE KOLJENA
DO TRAJENOG SMJERA
TE JE POUZDANO U SVAKOJ
POZICIJI. LAGANA MONTAŽA NA
BILO KAKVO KOLJENO
BEZ NITANJA.



1



2



3





ALUMINIUM POLYESTER + NATUR

INOX ZADRŽAČ SMEĆA

N-NZN





Nominalna veličina	EAN broj narudžbe	Pakiranje u kom		Cijena [€/kom]	
				Bez PDV	S PDV
60	001153	30	2 160	5,55	6,94
80	001160	20	1 440	5,60	7,00
100	001177	15	1 080	5,70	7,13
120	001184	10	720	6,20	7,75
150	001191	5	360	9,80	12,25



SABIRNI KOTLIĆ DESIGN

W-WKLZ DE

Nominalna veličina	80		100		120	
	Bez PDV	S PDV	Bez PDV	S PDV	Bez PDV	S PDV
AN 1 Antracit RAL 7016	99,90	124,88	99,90	124,88	105,00	131,25
	031044 *		031068		031082 *	
TM 2 Testa di Moro RAL 8028	99,90	124,88	99,90	124,88	105,00	131,25
	032249 *		032263		032287 *	
SS 3 Svijetlo siva RAL 7005	99,90	124,88	99,90	124,88	105,00	131,25
	032096 *		032119		032133 *	
ZH 4 Zeleno smeđa RAL 7013	99,90	124,88	99,90	124,88	105,00	131,25
	032393 *		032416		032430 *	
BH 5 Srebrna RAL 9006	99,90	124,88	99,90	124,88	105,00	131,25
	031341 *		031365		031389 *	
BHT 6 Tamno srebrna RAL 9007						
MH 7 Bakreno smeđa RAL 8004	99,90	124,88	99,90	124,88	105,00	131,25
	031648 *		031662 *		031686 *	
IC 8 Intenzivno crna RAL 9005	99,90	124,88	99,90	124,88	105,00	131,25
	031495 *		031518		031532 *	
OC 9 Vinsko crvena RAL 3009	99,90	124,88	99,90	124,88	105,00	131,25
	031945 *		031969 *		031983 *	
B 10 Bijela RAL 9010	99,90	124,88	99,90	124,88	105,00	131,25
	031198 *		031211		031235 *	
MZ 11 Mahunasto zelena RAL 6005	99,90	124,88	99,90	124,88	105,00	131,25
	031792 *		031815 *		031839 *	
ZS 12 Cink siva RAL extra	99,90	124,88	99,90	124,88	105,00	131,25
	032546 *		032560 *		032584 *	
PZ 13 Zelena patina RAL extra						
PM 14 Bakar patina RAL extra						
Aluminij 15 Natur	89,90	112,38	89,90	112,38	94,50	118,13
	030894 *		030917 *		030931 *	
Pak. u kom 		2		2		2
Pak. u kom 		36		36		36



* Proizvodnja po narudžbi



SABIRNI KOTLIĆ DESIGN EKSCENTRIČNI

W-WKLZ DX



Nominalna veličina	80		100		120	
	Bez PDV	S PDV	Bez PDV	S PDV	Bez PDV	S PDV
AN 1 Antracit RAL 7016	115,00	143,75	115,00	143,75	125,00	156,25
	031105 *		031136		031167	
TM 2 Testa di Moro RAL 8028	115,00	143,75	115,00	143,75	125,00	156,25
	032300 *		032331 *		032362 *	
SS 3 Svijetlo siva RAL 7005	115,00	143,75	115,00	143,75	125,00	156,25
	032157		032188		032218 *	
ZH 4 Zeleno smeđa RAL 7013	115,00	143,75	115,00	143,75	125,00	156,25
	032454 *		032485 *		032515 *	
BH 5 Srebrna RAL 9006	115,00	143,75	115,00	143,75	125,00	156,25
	031402 *		031433 *		031464 *	
BHT 6 Tamno srebrna RAL 9007	115,00	143,75	115,00	143,75	125,00	156,25
	101655 *		101679 *		101693 *	
MH 7 Bakreno smeđa RAL 8004	115,00	143,75	115,00	143,75	125,00	156,25
	031709 *		031730 *		031761 *	
IC 8 Intenzivno crna RAL 9005	115,00	143,75	115,00	143,75	125,00	156,25
	031556 *		031587 *		031617 *	
OC 9 Vinsko crvena RAL 3009	115,00	143,75	115,00	143,75	125,00	156,25
	032003 *		032034 *		032065 *	
B 10 Bijela RAL 9010	115,00	143,75	115,00	143,75	125,00	156,25
	031259 *		031280 *		031310 *	
MZ 11 Mahunasto zelena RAL 6005	115,00	143,75	115,00	143,75	125,00	156,25
	031853 *		031884 *		031914 *	
ZS 12 Cink siva RAL extra	115,00	143,75	115,00	143,75	125,00	156,25
	032607 *		032638 *		032669 *	
PZ 13 Zelena patina RAL extra						
PM 14 Bakar patina RAL extra						
Aluminij 15 Natur	103,50	129,38	110,00	137,50	112,50	140,63
	030955 *		030986 *		031013 *	
Pak. u kom 	2		2		2	
Pak. u kom 	36		36		36	

* Proizvodnja po narudžbi

SABIRNI KOTLIĆ KUBICKI

W-WKLZ KU

Nominalna veličina	80		100		120	
	Bez PDV	S PDV	Bez PDV	S PDV	Bez PDV	S PDV
AN 1 Antracit RAL 7016	128,00	160,00	128,00	160,00	145,00	181,25
	031051 *		031075		031099 *	
TM 2 Testa di Moro RAL 8028	128,00	160,00	128,00	160,00	145,00	181,25
	032256 *		032270 *		032294 *	
SS 3 Svijetlo siva RAL 7005	128,00	160,00	128,00	160,00	145,00	181,25
	032102 *		032126 *		032140 *	
ZH 4 Zeleno smeđa RAL 7013	128,00	160,00	128,00	160,00	145,00	181,25
	032409 *		032423 *		032447 *	
BH 5 Srebrna RAL 9006	128,00	160,00	128,00	160,00	145,00	181,25
	031358 *		031372 *		031396 *	
BHT 6 Tamno srebrna RAL 9007						
MH 7 Bakreno smeđa RAL 8004	128,00	160,00	128,00	160,00	145,00	181,25
	031655 *		031679 *		031693 *	
IC 8 Intenzivno crna RAL 9005	128,00	160,00	128,00	160,00	145,00	181,25
	031501 *		031525 *		031549 *	
OC 9 Vinsko crvena RAL 3009	128,00	160,00	128,00	160,00	145,00	181,25
	031952 *		031976 *		031990 *	
B 10 Bijela RAL 9010	128,00	160,00	128,00	160,00	145,00	181,25
	031204 *		031228 *		031242 *	
MZ 11 Mahunasto zelena RAL 6005	128,00	160,00	128,00	160,00	145,00	181,25
	031808 *		031822 *		031846 *	
ZS 12 Cink siva RAL extra	128,00	160,00	128,00	160,00	145,00	181,25
	032553 *		032577 *		032591 *	
PZ 13 Zelena patina RAL extra						
PM 14 Bakar patina RAL extra						
Aluminij 15 Natur	115,20	144,00	115,20	144,00	130,50	163,13
	030900 *		030924 *		030948 *	
Pak. u kom	2		2		2	
Pak. u kom	36		36		36	



* Proizvodnja po narudžbi

ALUMINIUM
POLYESTER + NATUR



SABIRNI KOTLIĆ KUBICKI EKSCENTRIČAN

W-WKLZ KX

Nominalna veličina	80		100		120	
	Bez PDV	S PDV	Bez PDV	S PDV	Bez PDV	S PDV
AN 1 Antracit RAL 7016	135,00	168,75	135,00	168,75	145,00	181,25
	031112 *		031143		031174 *	
TM 2 Testa di Moro RAL 8028	135,00	168,75	135,00	168,75	145,00	181,25
	032317 *		032348 *		032379 *	
SS 3 Svijetlo siva RAL 7005	135,00	168,75	135,00	168,75	145,00	181,25
	032164 *		032195 *		032225 *	
ZH 4 Zeleno smeđa RAL 7013	135,00	168,75	135,00	168,75	145,00	181,25
	032461 *		032492 *		032522 *	
BH 5 Srebrna RAL 9006	135,00	168,75	135,00	168,75	145,00	181,25
	031419 *		031440 *		031471 *	
BHT 6 Tamno srebrna RAL 9007	135,00	168,75	135,00	168,75	145,00	181,25
	101662 *		101686 *		101709 *	
MH 7 Bakreno smeđa RAL 8004	135,00	168,75	135,00	168,75	145,00	181,25
	031716 *		031747 *		031778 *	
IC 8 Intenzivno crna RAL 9005	135,00	168,75	135,00	168,75	145,00	181,25
	031563 *		031594 *		031624 *	
OC 9 Vinsko crvena RAL 3009	135,00	168,75	135,00	168,75	145,00	181,25
	032010 *		032041 *		032072 *	
B 10 Bijela RAL 9010	135,00	168,75	135,00	168,75	145,00	181,25
	031266 *		031297 *		031327 *	
MZ 11 Mahunasto zelena RAL 6005	135,00	168,75	135,00	168,75	145,00	181,25
	031860 *		031891 *		031921 *	
ZS 12 Cink siva RAL extra	135,00	168,75	135,00	168,75	145,00	181,25
	032614 *		032645 *		032676 *	
PZ 13 Zelena patina RAL extra						
PM 14 Bakar patina RAL extra						
Aluminij 15 Natur	121,50	151,88	121,50	151,88	130,50	163,13
	030962 *		030993 *		031020 *	
Pak. u kom 	2		2		2	
Pak. u kom 	36		36		36	



* Proizvodnja po narudžbi



ALUMINIUM POLYESTER + NATUR

SABIRNI KOTLIĆ KUBICKI EKSCENTRIČNI S OTVOROM

W-WKLZ KXV

Nominalna veličina	80		100		120	
	Bez PDV	S PDV	Bez PDV	S PDV	Bez PDV	S PDV
AN 1 Antracit RAL 7016	160,00	200,00	160,00	200,00	170,00	212,50
	031129 *		031150 *		031181 *	
TM 2 Testa di Moro RAL 8028	160,00	200,00	160,00	200,00	170,00	212,50
	032324 *		032355 *		032386 *	
SS 3 Svijetlo siva RAL 7005	160,00	200,00	160,00	200,00	170,00	212,50
	032171 *		032201 *		032232 *	
ZH 4 Zeleno smeđa RAL 7013	160,00	200,00	160,00	200,00	170,00	212,50
	032478 *		032508 *		032539 *	
BH 5 Srebrna RAL 9006	160,00	200,00	160,00	200,00	170,00	212,50
	031426 *		031457 *		031488 *	
BHT 6 Tamno srebrna RAL 9007						
MH 7 Bakreno smeđa RAL 8004	160,00	200,00	160,00	200,00	170,00	212,50
	031723 *		031754 *		031785 *	
IC 8 Intenzivno crna RAL 9005	160,00	200,00	160,00	200,00	170,00	212,50
	031570 *		031600 *		031631 *	
OC 9 Vinsko crvena RAL 3009	160,00	200,00	160,00	200,00	170,00	212,50
	032027 *		032058 *		032089 *	
B 10 Bijela RAL 9010	160,00	200,00	160,00	200,00	170,00	212,50
	031273 *		031303 *		031334 *	
MZ 11 Mahunasto zelena RAL 6005	160,00	200,00	160,00	200,00	170,00	212,50
	031877 *		031907 *		031938 *	
ZS 12 Cink siva RAL extra	160,00	200,00	160,00	200,00	170,00	212,50
	032621 *		032652 *		032683 *	
PZ 13 Zelena patina RAL extra						
PM 14 Bakar patina RAL extra						
Aluminij 15 Natur	144,00	180,00	144,00	180,00	153,00	191,25
	030979 *		031006 *		031037 *	
Pak. u kom 		2		2		2
Pak. u kom 		36		36		36

* Proizvodnja po narudžbi









ALUMINIUM
POLYESTER + NATUR



GUMA ZA BRTVLJENJE SABIRNOG KOTLIĆA

P-PKLZ T



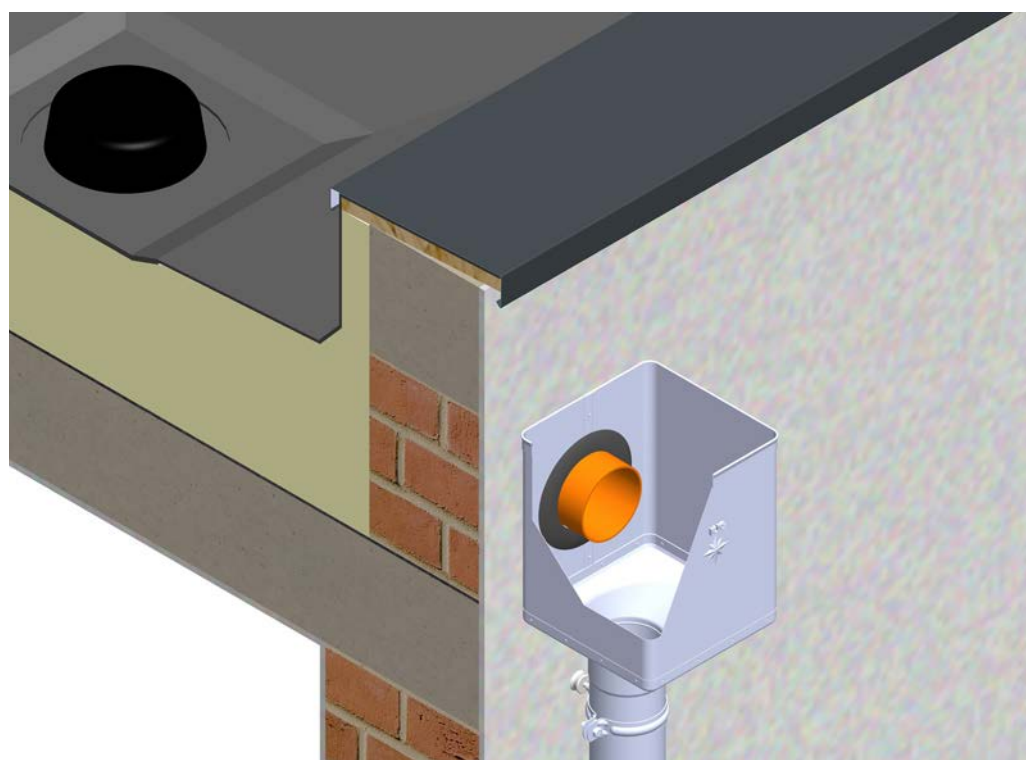

Nominalna veličina	EAN broj narudžbe	Pakiranje u kom		Cijena [€/kom]	
				Bez PDV	S PDV
 70-85	077103	5	600	4,00	5,00
 100-110	077110	5	600	4,10	5,13
 110-125	077097	5	600	4,20	5,25
 70-85	077134	5	600	4,50	5,63
 100-110	077141	5	600	4,90	6,13
 110-125	077127	5	600	5,00	6,25



VARENO KOLJENO 72°

W-WK

Nominalna veličina	60		80		100		120		150	
	Bez PDV	S PDV	Bez PDV	S PDV	Bez PDV	S PDV	Bez PDV	S PDV	Bez PDV	S PDV
AN 1 Antracit RAL 7016	9,20	11,50	9,00	11,25	9,60	12,00	14,60	18,25	32,50	40,63
	074294		074300		074324		074348		074362	
TM 2 Testa di Moro RAL 8028	9,20	11,50	9,00	11,25	9,60	12,00	14,60	18,25	32,50	40,63
	074935		074942		074966		074980		075000 *	
SS 3 Svijetlo siva RAL 7005	9,20	11,50	9,00	11,25	9,60	12,00	14,60	18,25	32,50	40,63
	074850 *		074867		074881		074904		074928 *	
ZH 4 Zeleno smeđa RAL 7013	9,20	11,50	9,00	11,25	9,60	12,00	14,60	18,25	32,50	40,63
	075017 *		075024		075048		075062		075086	
BH 5 Srebrna RAL 9006	9,20	11,50	9,00	11,25	9,60	12,00	14,60	18,25	32,50	40,63
	074461		074454		074485		074508		074522 *	
BHT 6 Tamno srebrna RAL 9007			9,00	11,25	9,60	12,00	14,60	18,25		
			101587		101563		101549 *			
MH 7 Bakreno smeđa RAL 8004	9,20	11,50	9,00	11,25	9,60	12,00	14,60	18,25	32,50	40,63
	074614		074621		074645		074669		074683 *	
IC 8 Intenzivno crna RAL 9005	9,20	11,50	9,00	11,25	9,60	12,00	14,60	18,25	32,50	40,63
	074539 *		074546		074560		074584		074607 *	
OC 9 Vinsko crvena RAL 3009	9,20	11,50	9,00	11,25	9,60	12,00	14,60	18,25	32,50	40,63
	074775 *		074782		074805		074829		074843 *	
B 10 Bijela RAL 9010	9,20	11,50	9,00	11,25	9,60	12,00	14,60	18,25	32,50	40,63
	074379		074386		074409		074423		074447 *	
MZ 11 Mahunasto zelena RAL 6005	9,20	11,50	9,00	11,25	9,60	12,00	14,60	18,25	32,50	40,63
	074690 *		074706		074720		074744		074768 *	
ZS 12 Cink siva RAL extra	9,20	11,50	9,00	11,25	9,60	12,00	14,60	18,25	32,50	40,63
	075093 *		075109		075123		075147		075161 *	
PZ 13 Zelena patina RAL extra					9,20	11,50				
					112644					
PM 14 Bakar patina RAL extra					9,20	11,50				
					112620					
Aluminij 15 Natur	8,10	10,13	8,10	10,13	8,90	11,13	14,50	18,13	29,00	36,25
	074218		074225		074249		074263		074287 *	
Pak. u kom 	25		25		25		15		5	
Pak. u kom 	600		400		300		180		60	



* Proizvodnja po narudžbi



VARENO KOLJENO 85°

W-WKR





Nominalna veličina	80		100		120	
	Bez PDV	S PDV	Bez PDV	S PDV	Bez PDV	S PDV
AN 1 Antracit RAL 7016	11,20	14,00	14,00	17,50	18,00	22,50
	074317		074331		074355 *	
TM 2 Testa di Moro RAL 8028	11,20	14,00	14,00	17,50	18,00	22,50
	074959		074973		074997 *	
SS 3 Svijetlo siva RAL 7005	11,20	14,00	14,00	17,50	18,00	22,50
	074874 *		074898		074911 *	
ZH 4 Zeleno smeđa RAL 7013	11,20	14,00	14,00	17,50	18,00	22,50
	075031 *		075055		075079 *	
BH 5 Srebrna RAL 9006	11,20	14,00	14,00	17,50	18,00	22,50
	074478 *		074492		074515 *	
BHT 6 Tamno srebrna RAL 9007	11,20	14,00	14,00	17,50	18,00	22,50
	101570 *		101556 *		101532 *	
MH 7 Bakreno smeđa RAL 8004	11,20	14,00	14,00	17,50	18,00	22,50
	074638 *		074652		074676 *	
IC 8 Intenzivno crna RAL 9005	11,20	14,00	14,00	17,50	18,00	22,50
	074553 *		074577 *		074591 *	
OC 9 Vinsko crvena RAL 3009	11,20	14,00	14,00	17,50	18,00	22,50
	074799 *		074812 *		074836 *	
B 10 Bijela RAL 9010	11,20	14,00	14,00	17,50	18,00	22,50
	074393		074416		074430 *	
MZ 11 Mahunasto zelena RAL 6005	11,20	14,00	14,00	17,50	18,00	22,50
	074713 *		074737 *		074751 *	
ZS 12 Cink siva RAL extra	11,20	14,00	14,00	17,50	18,00	22,50
	075116 *		075130 *		075154 *	
PZ 13 Zelena patina RAL extra			9,80	12,25		
				112651		
PM 14 Bakar patina RAL extra			9,80	12,25		
				112637		
Aluminij 15 Natur	10,10	12,63	12,60	15,75	16,20	20,25
	074232 *		074256		074270 *	
Pak. u kom 		25		25		15
Pak. u kom 		400		300		180

* Proizvodnja po narudžbi

VARENO KOLJENO 40°

W-WKT

Nominalna veličina	80		100		120	
	Bez PDV	S PDV	Bez PDV	S PDV	Bez PDV	S PDV
AN 1 Antracit RAL 7016	8,90	11,13	11,00	13,75	14,90	18,63
	081414		081421		081438	
TM 2 Testa di Moro RAL 8028	8,90	11,13	11,00	13,75	14,90	18,63
	081650		081667		081674 *	
SS 3 Svijetlo siva RAL 7005	8,90	11,13	11,00	13,75	14,90	18,63
	081629		081636		081643	
ZH 4 Zeleno smeđa RAL 7013	8,90	11,13	11,00	13,75	14,90	18,63
	081681		081698		081704	
BH 5 Srebrna RAL 9006	8,90	11,13	11,00	13,75	14,90	18,63
	081476		081483		081490 *	
BHT 6 Tamno srebrna RAL 9007	8,90	11,13	11,00	13,75	14,90	18,63
	101778 *		101785 *		101792 *	
MH 7 Bakreno smeđa RAL 8004	8,90	11,13	11,00	13,75	14,90	18,63
	081537		081544		081551 *	
IC 8 Intenzivno crna RAL 9005	8,90	11,13	11,00	13,75	14,90	18,63
	081506 *		081513 *		081520 *	
OC 9 Vinsko crvena RAL 3009	8,90	11,13	11,00	13,75	14,90	18,63
	081599 *		081605		081612 *	
B 10 Bijela RAL 9010	8,90	11,13	11,00	13,75	14,90	18,63
	081445		081452		081469	
MZ 11 Mahunasto zelena RAL 6005	8,90	11,13	11,00	13,75	14,90	18,63
	081568		081575		081582	
ZS 12 Cink siva RAL extra	8,90	11,13	11,00	13,75	14,90	18,63
	081711		081728		081735	
PZ 13 Zelena patina RAL extra						
PM 14 Bakar patina RAL extra						
Aluminij 15 Natur	8,00	10,00	9,90	12,38	13,95	17,44
	081384		081391		081407	
Pak. u kom 	25		25		15	
Pak. u kom 	400		300		240	

* Proizvodnja po narudžbi



ODVODNA CIJEV [s=0,70]

W-WZR



Nominalna veličina	60		80		80		80		
Dužina u m	2,0		3,0		4,0		6,0		
Cijena u €/m	Bez PDV	S PDV	Bez PDV	S PDV	Bez PDV	S PDV	Bez PDV	S PDV	
AN Antracit RAL 7016	1	7,50	9,38	6,35	7,94	6,35	7,94	6,35	7,94
		050106	050113	050120	050137 *				
TM Testa di Moro RAL 8028	2	7,50	9,38	6,35	7,94	6,35	7,94	6,35	7,94
		050762	050779	050786	050793 *				
SS Svijetlo siva RAL 7005	3	7,50	9,38	6,35	7,94	6,35	7,94	6,35	7,94
		050687	050694	050700	052032 *				
ZH Zeleno smeđa RAL 7013	4	7,50	9,38	6,35	7,94	6,35	7,94	6,35	7,94
		050861	050878	051059	050892 *				
BH Srebrna RAL 9006	5	7,50	9,38	6,35	7,94	6,35	7,94	6,35	7,94
		050281	050298	050304	098283 *				
BHT Tamno srebrna RAL 9007	6			6,35	7,94				
				101952 *					
MH Bakreno smeđa RAL 8004	7	7,50	9,38	6,35	7,94	6,35	7,94		
		050441 *	050458	050465					
IC Intenzivno crna RAL 9005	8	7,50	9,38	6,35	7,94	6,35	7,94		
		050366 *	050373	050380					
OC Vinsko crvena RAL 3009	9	7,50	9,38	6,35	7,94	6,35	7,94		
		050601	050618	050625 *					
B Bijela RAL 9010	10	7,50	9,38	6,35	7,94	6,35	7,94		
		050205	050212	050229					
MZ Mahunasto zelena RAL 6005	11	7,50	9,38	6,35	7,94	6,35	7,94		
		050526	050533	050540					
ZS Cink siva RAL extra	12	7,50	9,38	6,35	7,94	6,35	7,94		
		050960 *	050977	050984 *					
PZ Zelena patina RAL extra	13								
PM Bakar patina RAL extra	14								
Aluminij Natur	15	6,30	7,88	5,65	7,06	5,65	7,06	5,65	7,06
		050021	050038	050045	052070 *				
Pak. u m 		10		18		24		30	
Pak. u m 		490		216		288		750	

* Proizvodnja po narudžbi



ODVODNA CIJEV [s=0,70]

W-WZR

Nominalna veličina	100		100		100	
	3,0		4,0		6,0	
Dužina u m	3,0		4,0		6,0	
Cijena u €/m	Bez PDV	S PDV	Bez PDV	S PDV	Bez PDV	S PDV
	AN 1 Antracit RAL 7016	7,05	8,81	7,05	8,81	6,95
050144		050151		050168 *		
TM 2 Testa di Moro RAL 8028	7,05	8,81	7,05	8,81	6,95	8,69
	050809		050816		050823 *	
SS 3 Svijetlo siva RAL 7005	7,05	8,81	7,05	8,81	6,95	8,69
	050717		050724		052049 *	
ZH 4 Zeleno smeđa RAL 7013	7,05	8,81	7,05	8,81	6,95	8,69
	050908		050915		050922 *	
BH 5 Srebrna RAL 9006	7,05	8,81	7,05	8,81	6,95	8,69
	050311		050328		052056 *	
BHT 6 Tamno srebrna RAL 9007	7,05	8,81	7,05	8,81		
	101969		101976			
MH 7 Bakreno smeđa RAL 8004	7,05	8,81	7,05	8,81		
	050472		050489			
IC 8 Intenzivno crna RAL 9005	7,05	8,81	7,05	8,81		
	050397		050403			
OC 9 Vinsko crvena RAL 3009	7,05	8,81	7,05	8,81		
	050632		050649			
B 10 Bijela RAL 9010	7,05	8,81	7,05	8,81		
	050236		050243			
MZ 11 Mahunasto zelena RAL 6005	7,05	8,81	7,05	8,81		
	050557		050564			
ZS 12 Cink siva RAL extra	7,05	8,81	7,05	8,81		
	050991		051004			
PZ 13 Zelena patina RAL extra	9,95	12,44	9,95	12,44		
	112828		112835 *			
PM 14 Bakar patina RAL extra	9,95	12,44	9,95	12,44		
	112804		112811 *			
Aluminij 15 Natur	6,70	8,38	6,70	8,38	6,55	8,19
	050052		050069		052025 *	
Pak. u m 	18		24		30	
Pak. u m 	180		240		480	

* Proizvodnja po narudžbi



ODVODNA CIJEV [s=0,70]

W-WZR

Nominalna veličina	120		120		120		150	
Dužina u m	3,0		4,0		6,0		3,0	
Cijena u €/m	Bez PDV	S PDV	Bez PDV	S PDV	Bez PDV	S PDV	Bez PDV	S PDV
AN 1 Antracit RAL 7016	9,50	11,88	9,50	11,88			14,75	18,44
	050175		050182				050199 *	
TM 2 Testa di Moro RAL 8028	9,50	11,88	9,50	11,88	9,50	11,88	14,75	18,44
	050830		050847		052063 *		050854 *	
SS 3 Svijetlo siva RAL 7005	9,50	11,88	9,50	11,88			14,75	18,44
	050731		050748				050755 *	
ZH 4 Zeleno smeđa RAL 7013	9,50	11,88	9,50	11,88			14,75	18,44
	050939		050946				050953 *	
BH 5 Srebrna RAL 9006	9,50	11,88	9,50	11,88			14,75	18,44
	050335		050342				050359 *	
BHT 6 Tamno srebrna RAL 9007	9,50	11,88						
	101983							
MH 7 Bakreno smeđa RAL 8004	9,50	11,88	9,50	11,88			14,75	18,44
	050496		050502				050519 *	
IC 8 Intenzivno crna RAL 9005	9,50	11,88	9,50	11,88			14,75	18,44
	050410		050427				050434 *	
OC 9 Vinsko crvena RAL 3009	9,50	11,88	9,50	11,88			14,75	18,44
	050656		050663				050670 *	
B 10 Bijela RAL 9010	9,50	11,88	9,50	11,88			14,75	18,44
	050250		050267				050274 *	
MZ 11 Mahunasto zelena RAL 6005	9,50	11,88	9,50	11,88			14,75	18,44
	050571		050588				050595 *	
ZS 12 Cink siva RAL extra	9,50	11,88	9,50	11,88			14,75	18,44
	051011 *		051028				051035 *	
PZ 13 Zelena patina RAL extra								
PM 14 Bakar patina RAL extra								
Aluminij 15 Natur	8,30	10,38	8,30	10,38			13,00	16,25
	050076		050083				050090 *	
Pak. u m 	18		24		30		3	
Pak. u m 	144		192		-		84	

* Proizvodnja po narudžbi





ALUMINIUM POLYESTER + NATUR



PVC IZLJEVNI RUKAV

SD-ZR FOLIA KJG

Nominalna veličina	Dužina u m	EAN broj narudžbe	Pakiranje u m		Cijena [€/m]	
					Bez PDV	S PDV
60-150	100,0	139726	100	6 000	0,38	0,48

KOLJENO ODSKOČNO

W-WKO





Nominalna veličina	80		100		120	
	Bez PDV	S PDV	Bez PDV	S PDV	Bez PDV	S PDV
AN 1 Antracit RAL 7016	11,00	13,75	13,50	16,88	16,00	20,00
	063328		008411		011985	
TM 2 Testa di Moro RAL 8028	11,00	13,75	13,50	16,88	16,00	20,00
	023353		023377		023421	
SS 3 Svijetlo siva RAL 7005	11,00	13,75	13,50	16,88	16,00	20,00
	023230		023285		023919	
ZH 4 Zeleno smeđa RAL 7013	11,00	13,75	13,50	16,88	16,00	20,00
	023476		023513		023537	
BH 5 Srebrna RAL 9006	11,00	13,75	13,50	16,88	16,00	20,00
	064837		057877		057884	
BHT 6 Tamno srebrna RAL 9007	11,00	13,75	13,50	16,88	16,00	20,00
	101716		101723		101730 *	
MH 7 Bakreno smeđa RAL 8004	11,00	13,75	13,50	16,88	16,00	20,00
	000316		000330		048738	
IC 8 Intenzivno crna RAL 9005	11,00	13,75	13,50	16,88	16,00	20,00
	057891		057907		048226 *	
OC 9 Vinsko crvena RAL 3009	11,00	13,75	13,50	16,88	16,00	20,00
	000507		068712		023209	
B 10 Bijela RAL 9010	11,00	13,75	13,50	16,88	16,00	20,00
	012029		013804		013811	
MZ 11 Mahunasto zelena RAL 6005	11,00	13,75	13,50	16,88	16,00	20,00
	011923		000453		000477	
ZS 12 Cink siva RAL extra	11,00	13,75	13,50	16,88	16,00	20,00
	023582		023629		023650	
PZ 13 Zelena patina RAL extra			16,90	21,13		
			112699			
PM 14 Bakar patina RAL extra			16,90	21,13		
			112682			
Aluminij 15 Natur	9,90	12,38	12,15	15,19	14,40	18,00
	077165		077172		077189	
Pak. u kom 	20		20		15	
Pak. u kom 	320		240		180	

* Proizvodnja po narudžbi

REDUKCIJA CIJEVI 72°

W-WZO



Nominalna veličina	80/80		100/80		100/100	
	Bez PDV	S PDV	Bez PDV	S PDV	Bez PDV	S PDV
AN 1 Antracit RAL 7016	38,50	48,13	39,50	49,38	39,90	49,88
	096630 *		096647 *		096654	
TM 2 Testa di Moro RAL 8028	38,50	48,13	39,50	49,38	39,90	49,88
	110473 *		110480 *		110497	
SS 3 Svijetlo siva RAL 7005	38,50	48,13	39,50	49,38	39,90	49,88
	110404 *		110411 *		110428 *	
ZH 4 Zeleno smeđa RAL 7013	38,50	48,13	39,50	49,38	39,90	49,88
	110541 *		110558 *		110565	
BH 5 Srebrna RAL 9006	38,50	48,13	39,50	49,38	39,90	49,88
	110053 *		110060 *		110077 *	
BHT 6 Tamno srebrna RAL 9007	38,50	48,13	39,50	49,38	39,90	49,88
	110053 *		110060 *		110077 *	
MH 7 Bakreno smeđa RAL 8004	38,50	48,13	39,50	49,38	39,90	49,88
	110190 *		110206 *		110213 *	
IC 8 Intenzivno crna RAL 9005	38,50	48,13	39,50	49,38	39,90	49,88
	110121 *		110138 *		110145 *	
OC 9 Vinsko crvena RAL 3009	38,50	48,13	39,50	49,38	39,90	49,88
	110336 *		110343 *		110350 *	
B 10 Bijela RAL 9010	38,50	48,13	39,50	49,38	39,90	49,88
	109989 *		109996 *		110008 *	
MZ 11 Mahunasto zelena RAL 6005	38,50	48,13	39,50	49,38	39,90	49,88
	110268 *		110275 *		110282	
ZS 12 Cink siva RAL extra	38,50	48,13	39,50	49,38	39,90	49,88
	110619 *		110626 *		110633 *	
PZ 13 Zelena patina RAL extra						
PM 14 Bakar patina RAL extra						
Aluminij 15 Natur	34,60	43,25	35,50	44,38	35,90	44,88
	096562 *		096579 *		096586 *	
Pak. u kom 	4		4		4	
Pak. u kom 	90		120		120	

* Proizvodnja po narudžbi

REDUKCIJA CIJEVI 72°

W-WZO





Nominalna veličina	120/80		120/100		120/120	
	Bez PDV	S PDV	Bez PDV	S PDV	Bez PDV	S PDV
AN 1 Antracit RAL 7016	43,00	53,75	43,60	54,50	43,90	54,88
	096661 *		096678 *		096685 *	
TM 2 Testa di Moro RAL 8028	43,00	53,75	43,60	54,50	43,90	54,88
	110503 *		110510 *		110527 *	
SS 3 Svijetlo siva RAL 7005	43,00	53,75	43,60	54,50	43,90	54,88
	110435 *		110442 *		110459 *	
ZH 4 Zeleno smeđa RAL 7013	43,00	53,75	43,60	54,50	43,90	54,88
	110572 *		110589 *		110596 *	
BH 5 Srebrna RAL 9006	43,00	53,75	43,60	54,50	43,90	54,88
	110084 *		110091 *		110107 *	
BHT 6 Tamno srebrna RAL 9007	43,00	53,75	43,60	54,50	43,90	54,88
	110084 *		110091 *		110107 *	
MH 7 Bakreno smeđa RAL 8004	43,00	53,75	43,60	54,50	43,90	54,88
	110220 *		110237 *		110244 *	
IC 8 Intenzivno crna RAL 9005	43,00	53,75	43,60	54,50	43,90	54,88
	110152 *		110169 *		110176 *	
OC 9 Vinsko crvena RAL 3009	43,00	53,75	43,60	54,50	43,90	54,88
	110367 *		110374 *		110381 *	
B 10 Bijela RAL 9010	43,00	53,75	43,60	54,50	43,90	54,88
	110015 *		110022 *		110039 *	
MZ 11 Mahunasto zelena RAL 6005	43,00	53,75	43,60	54,50	43,90	54,88
	110299 *		110305 *		110312 *	
ZS 12 Cink siva RAL extra	43,00	53,75	43,60	54,50	43,90	54,88
	110640 *		110657 *		110664 *	
PZ 13 Zelena patina RAL extra						
PM 14 Bakar patina RAL extra						
Aluminij 15 Natur	38,70	48,38	39,30	49,13	39,50	49,38
	096593 *		096609 *		096616 *	
Pak. u kom 	3		3		3	
Pak. u kom 	90		90		90	

* Proizvodnja po narudžbi

ZVODOVÁ OBJÍMKA M10

W-WOB

Nominalna veličina	60		80		100		120		150	
	Bez PDV	S PDV	Bez PDV	S PDV	Bez PDV	S PDV	Bez PDV	S PDV	Bez PDV	S PDV
AN 1 Antracit RAL 7016	3,55	4,44	3,35	4,19	3,40	4,25	3,90	4,88	5,85	7,31
	054982		054999		055002		055019		055026	
TM 2 Testa di Moro RAL 8028	3,55	4,44	3,35	4,19	3,40	4,25	3,90	4,88	5,85	7,31
	055439		055446		055453		055460		055477 *	
SS 3 Svijetlo siva RAL 7005	3,55	4,44	3,35	4,19	3,40	4,25	3,90	4,88	5,85	7,31
	055330 *		055347		055354		055361		055378 *	
ZH 4 Zeleno smeđa RAL 7013	3,55	4,44	3,35	4,19	3,40	4,25	3,90	4,88	5,85	7,31
	055514		055521		055538		055545		055552 *	
BH 5 Srebrna RAL 9006	3,55	4,44	3,35	4,19	3,40	4,25	3,90	4,88	5,85	7,31
	055088		055095		055101		055118		055125 *	
BHT 6 Tamno srebrna RAL 9007			3,35	4,19	3,40	4,25	3,90	4,88		
			101808		101815		101822 *			
MH 7 Bakreno smeđa RAL 8004	3,55	4,44	3,35	4,19	3,40	4,25	3,90	4,88	5,85	7,31
	055187 *		055194		055200		055217		055224 *	
IC 8 Intenzivno crna RAL 9005	3,55	4,44	3,35	4,19	3,40	4,25	3,90	4,88	5,85	7,31
	055132 *		055149		055156		055163		055170 *	
OC 9 Vinsko crvena RAL 3009	3,55	4,44	3,35	4,19	3,40	4,25	3,90	4,88	5,85	7,31
	055286 *		055293		055309		055316		055323 *	
B 10 Bijela RAL 9010	3,55	4,44	3,35	4,19	3,40	4,25	3,90	4,88	5,85	7,31
	055033		055040		055057		055064		055071 *	
MZ 11 Mahunasto zelena RAL 6005	3,55	4,44	3,35	4,19	3,40	4,25	3,90	4,88	5,85	7,31
	055231 *		055248		055255		055262		055279 *	
ZS 12 Cink siva RAL extra	3,55	4,44	3,35	4,19	3,40	4,25	3,90	4,88	5,85	7,31
	055569 *		055576		055583		055590		055606 *	
PZ 13 Zelena patina RAL extra					8,30	10,38				
					112712					
PM 14 Bakar patina RAL extra					8,30	10,38				
					112705					
Aluminij 15 Natur	2,80	3,50	2,60	3,25	2,70	3,38	3,00	3,75	4,65	5,81
	054906 *		054913		054920		054937		054944 *	
Pak. u kom 	25		25		25		25		20	
Pak. u kom 	3 000		3 000		3 000		3 000		2 400	



* Proizvodnja po narudžbi



INOX VIJAK ZA OBUJMICU M8x30

P-POB-NSK





Nominalna veličina	EAN broj narudžbe	Pakiranje u kom		Cijena [€/kom]	
				Bez PDV	S PDV
M8 x 30 *	139658	1	–	0,25	0,31

* Proizvodnja po narudžbi

VIJAK ZA OBUJMICU TORX M10

P-POB-HT





Nominalna veličina	EAN broj narudžbe	Pakiranje u kom		Cijena [€/kom]	
				Bez PDV	S PDV
80	002464	100	40 000	1,00	1,25
140	002471	100	28 000	1,25	1,56
200	002488	100	20 000	1,55	1,94
250	002495	100	16 000	1,70	2,13
300	002501	100	11 200	1,70	2,13

ALUMINIUM
POLYESTER + NATUR

TIPLA M10

P-POB-HN DB





Nominalna veličina	EAN broj narudžbe	Pakiranje u kom		Cijena [€/kom]	
				Bez PDV	S PDV
120	002426	100	25 000	0,40	0,50

TIPLA S LAMELOM M10

P-POB-HN DB





Nominalna veličina	EAN broj narudžbe	Pakiranje u kom		Cijena [€/kom]	
				Bez PDV	S PDV
180	002433	100	12 000	0,42	0,53
240	002440	100	12 000	0,50	0,63
280	002457	100	12 000	0,53	0,66

KOMBINIRANI VIJAK TORX M10

P-POB-ZT/SZ





Nominalna veličina	EAN broj narudžbe	Pakiranje u kom		Cijena [€/kom]	
				Bez PDV	S PDV
140	002587	50	10 400	0,45	0,56
180	002594	50	10 400	0,55	0,69

TIPLA ZA IZOLACIJU M10

P-POB-HN IZOL





Nominalna veličina	EAN broj narudžbe	Pakiranje u kom		Cijena [€/kom]	
				Bez PDV	S PDV
M10 x 96	001207	25	2 625	2,70	3,38

KLIN SA PVC TIPLOM ZA OPEKU BEZ IZOLACIJE

P-POB-HN WDVS140 M10





Nominalna veličina	EAN broj narudžbe	Pakiranje u kom		Cijena [€/kom]	
				Bez PDV	S PDV
140	144843	1/5	750	4,80	6,00

KLIN SA PVC TIPLOM ZA OPEKU SA IZOLACIJOM

P-POB-HN WDVS300 M10





Nominalna veličina	EAN broj narudžbe	Pakiranje u kom		Cijena [€/kom]	
				Bez PDV	S PDV
300	144850	1/5	500	7,80	9,75

UNI NASTAVAK OD NEHRĐAJUĆEG ČELIKA ZA PRIČVRŠČIVANJE OB M10

P-POB-HN PLAT M10





Nominalna veličina	EAN broj narudžbe	Pakiranje u kom		Cijena [€/kom]	
				Bez PDV	S PDV
M10	144836	25/500	5 000	3,35	4,19

NAVOJNA ŠIPKA M10

P-POB-ZT





Nominalna veličina	EAN broj narudžbe	Pakiranje u kom		Cijena [€/kom]	
				Bez PDV	S PDV
60	002556	100	20 800	0,20	0,25
100	002563	100	15 600	0,30	0,38
150	002570	50	10 400	0,55	0,69

MONTAŽNA PLOČICA M10

P-POB-ZT MP





Nominalna veličina	EAN broj narudžbe	Pakiranje u kom		Cijena [€/kom]	
				Bez PDV	S PDV
80 x 30	002518	25	5 200	1,15	1,44

ZAŠTITNI POKLOPAC OBUJMIC

P-POB-HT AKG





Nominalna veličina	EAN broj narudžbe	Pakiranje u kom		Cijena [€/kom]	
				Bez PDV	S PDV
TM 29 x 13	002280	50	16 800	0,25	0,31
AN 29 x 13	002211	50	16 800	0,25	0,31
IC 29 x 13	002235	50	16 800	0,25	0,31
OC 29 x 13	002266	50	16 800	0,25	0,31
MH 29 x 13	002242	50	16 800	0,25	0,31
B SB 29 x 13	002228	50	16 800	0,25	0,31
PS BH BHT 29 x 13	002273	50	16 800	0,25	0,31
MZ 29 x 13	002259	50	16 800	0,25	0,31
ZH 29 x 13	002297	50	16 800	0,25	0,31

ZADRŽAČ VODE



W-WZV



Nominalna veličina	80		100		120	
Cijena u €/kom	Bez PDV		Bez PDV		Bez PDV	
AN 1 Antracit RAL 7016	21,00	26,25	22,00	27,50	30,00	37,50
	035073		035080		035097	
TM 2 Testa di Moro RAL 8028	21,00	26,25	22,00	27,50	30,00	37,50
	035103		035110		035127	
ZH 4 Zeleno smeđa RAL 7013	21,00	26,25	22,00	27,50	30,00	37,50
	035134		035141		035158	
Pak. u kom 	6		5		3	
Pak. u kom 	180		150		90	

ZADRŽAČ VODE+SÍTKO

W-WZVS

Nominalna veličina	80		100		120	
	Bez PDV	S PDV	Bez PDV	S PDV	Bez PDV	S PDV
AN 1 Antracit RAL 7016	25,50	31,88	28,00	35,00	42,00	52,50
	035226		035233		035240	
TM 2 Testa di Moro RAL 8028	25,50	31,88	28,00	35,00	42,00	52,50
	035462		035479		035486	
SS 3 Svijetlo siva RAL 7005	25,50	31,88	28,00	35,00	42,00	52,50
	035431		035448		035455	
ZH 4 Zeleno smeđa RAL 7013	25,50	31,88	28,00	35,00	42,00	52,50
	035493		035509		035516	
BH 5 Srebrna RAL 9006	25,50	31,88	28,00	35,00	42,00	52,50
	035288		035295		035301	
BHT 6 Tamno srebrna RAL 9007	25,50	31,88	28,00	35,00	42,00	52,50
	102034 *		102041 *		102058 *	
MH 7 Bakreno smeđa RAL 8004	25,50	31,88	28,00	35,00	42,00	52,50
	035349		035356		035363	
IC 8 Intenzivno crna RAL 9005	25,50	31,88	28,00	35,00	42,00	52,50
	035318		035325		035332 *	
OC 9 Vinsko crvena RAL 3009	25,50	31,88	28,00	35,00	42,00	52,50
	035400		035417		035424	
B 10 Bijela RAL 9010	25,50	31,88	28,00	35,00	42,00	52,50
	035257		035264		035271	
MZ 11 Mahunasto zelena RAL 6005	25,50	31,88	28,00	35,00	42,00	52,50
	035370		035387		035394	
ZS 12 Cink siva RAL extra	25,50	31,88	28,00	35,00	42,00	52,50
	035523		035530		035547	
PZ 13 Zelena patina RAL extra						
PM 14 Bakar patina RAL extra						
Aluminij 15 Natur	20,40	25,50	22,40	28,00	33,60	42,00
	035196 *		035202		035219 *	
Pak. u kom 	6		5		3	
Pak. u kom 	180		150		90	

* Proizvodnja po narudžbi



ZADRŽAČ VODE+HADICA



W-WZVHA



Dimenzija: 80, 120



Dimenzija: 100

Nominalna veličina	80		100		120	
	Bez PDV	S PDV	Bez PDV	S PDV	Bez PDV	S PDV
AN 1 Antracit RAL 7016	65,00	81,25	60,00	75,00	125,00	156,25
	018854		018861		018878 *	
TM 2 Testa di Moro RAL 8028	65,00	81,25	60,00	75,00	125,00	156,25
	019097		019103		019110	
SS 3 Svijetlo siva RAL 7005	65,00	81,25	60,00	75,00	125,00	156,25
	019066 *		019073		019080 *	
ZH 4 Zeleno smeđa RAL 7013	65,00	81,25	60,00	75,00	125,00	156,25
	019127 *		019134		019141 *	
BH 5 Srebrna RAL 9006	65,00	81,25	60,00	75,00	125,00	156,25
	018915 *		018922		018939 *	
BHT 6 Tamno srebrna RAL 9007	65,00	81,25	60,00	75,00	125,00	156,25
	102003 *		102010 *		102027 *	
MH 7 Bakreno smeđa RAL 8004	65,00	81,25	60,00	75,00	125,00	156,25
	018977 *		018984 *		018991 *	
IC 8 Intenzivno crna RAL 9005	65,00	81,25	60,00	75,00	125,00	156,25
	018946 *		018953		018960	
OC 9 Vinsko crvena RAL 3009	65,00	81,25	60,00	75,00	125,00	156,25
	019035 *		019042 *		019059 *	
B 10 Bijela RAL 9010	65,00	81,25	60,00	75,00	125,00	156,25
	018885 *		018892		018908 *	
MZ 11 Mahunasto zelena RAL 6005	65,00	81,25	60,00	75,00	125,00	156,25
	019004		019011		019028 *	
ZS 12 Cink siva RAL extra	65,00	81,25	60,00	75,00	125,00	156,25
	019158 *		019165 *		019172 *	
PZ 13 Zelena patina RAL extra						
PM 14 Bakar patina RAL extra						
Aluminij 15 Natur	58,50	73,13	54,00	67,50	112,50	140,63
	001481		001498		001504	
Pak. u kom 	1		1		1	
Pak. u kom 	60		60		60	

* Proizvodnja po narudžbi

POCINČANA OBOJENA ZAŠTITNA CIJEV S REV. OB

W-WOZR



Nominalna veličina	80		100		100	
Dužina u m	1,0		1,0		1,5	
Cijena u €/kom	Bez PDV	S PDV	Bez PDV	S PDV	Bez PDV	S PDV
AN 1 Antracit RAL 7016	64,00	80,00	49,00	61,25	97,00	121,25
	030344 *		030351 *		030368 *	
TM 2 Testa di Moro RAL 8028	64,00	80,00	49,00	61,25	97,00	121,25
	030641 *		030658 *		030665 *	
SS 3 Svijetlo siva RAL 7005	64,00	80,00	49,00	61,25	97,00	121,25
	030597 *		030603 *		030610 *	
ZH 4 Zeleno smeđa RAL 7013	64,00	80,00	49,00	61,25	97,00	121,25
	030696 *		030702 *		030719 *	
BH 5 Srebrna RAL 9006	64,00	80,00	49,00	61,25	97,00	121,25
	030795 *		030801 *		030818 *	
BHT 6 Tamno srebrna RAL 9007	64,00	80,00	49,00	61,25	97,00	121,25
	102065 *		102072 *		102096 *	
MH 7 Bakreno smeđa RAL 8004	64,00	80,00	49,00	61,25	97,00	121,25
	030443 *		030450 *		030467 *	
IC 8 Intenzivno crna RAL 9005	64,00	80,00	49,00	61,25	97,00	121,25
	030849 *		030856 *		030863 *	
OC 9 Vinsko crvena RAL 3009	64,00	80,00	49,00	61,25	97,00	121,25
	030542 *		030559 *		030566 *	
B 10 Bijela RAL 9010	64,00	80,00	49,00	61,25	97,00	121,25
	030399 *		030405 *		030412 *	
MZ 11 Mahunasto zelena RAL 6005	64,00	80,00	49,00	61,25	97,00	121,25
	030498 *		030504 *		030511 *	
ZS 12 Cink siva RAL extra	64,00	80,00	49,00	61,25	97,00	121,25
	030740 *		030757 *		030764 *	
PZ 13 Zelena patina RAL extra						
PM 14 Bakar patina RAL extra						
Pocink Natur	60,00	75,00	45,00	56,25	89,00	111,25
	009708		009715		009722	
Pak. u kom 	1		1		1	
Pak. u kom 	70		60		60	

* Proizvodnja po narudžbi



POCINČANA OBOJENA ZAŠTITNA CIJEV S REV. OB

W-WOZR

Nominalna veličina	120		120	
Dužina u m	1,0		1,5	
Cijena u €/kom	Bez PDV	S PDV	Bez PDV	S PDV
AN Antracit RAL 7016	115,00	143,75	165,00	206,25
		030375 *		030382 *
TM Testa di Moro RAL 8028	115,00	143,75	165,00	206,25
		030672 *		030689 *
SS Svijetlo siva RAL 7005	115,00	143,75	165,00	206,25
		030627 *		030634 *
ZH Zeleno smeđa RAL 7013	115,00	143,75	165,00	206,25
		030726 *		030733 *
BH Srebrna RAL 9006	115,00	143,75	165,00	206,25
		030825 *		030832 *
BHT Tamno srebrna RAL 9007	115,00	143,75	165,00	206,25
		102102 *		102089 *
MH Bakreno smeđa RAL 8004	115,00	143,75	165,00	206,25
		030474 *		030481 *
IC Intenzivno crna RAL 9005	115,00	143,75	165,00	206,25
		030870 *		030887 *
OC Vinsko crvena RAL 3009	115,00	143,75	165,00	206,25
		030573 *		030580 *
B Bijela RAL 9010	115,00	143,75	165,00	206,25
		030429 *		030436 *
MZ Mahunasto zelena RAL 6005	115,00	143,75	165,00	206,25
		030528 *		030535 *
ZS Cink siva RAL extra	115,00	143,75	165,00	206,25
		030771 *		030788 *
PZ Zelena patina RAL extra				
PM Bakar patina RAL extra				
Pocink Natur	105,00	131,25	143,00	178,75
		009739		009746
Pak. u kom 	1		1	
Pak. u kom 	40		40	

* Proizvodnja po narudžbi





ALUMINIUM

POLYESTER + NATUR

OBUJMICA S GUMOM M10

P-POB-OZR



Nominalna veličina	EAN broj narudžbe	Pakiranje u kom		Cijena [€/kom]	
				Bez PDV	S PDV
80	002525	25	1 250	1,55	1,94
100	002532	25	1 250	2,00	2,50
120	002549	20	1 000	2,25	2,81

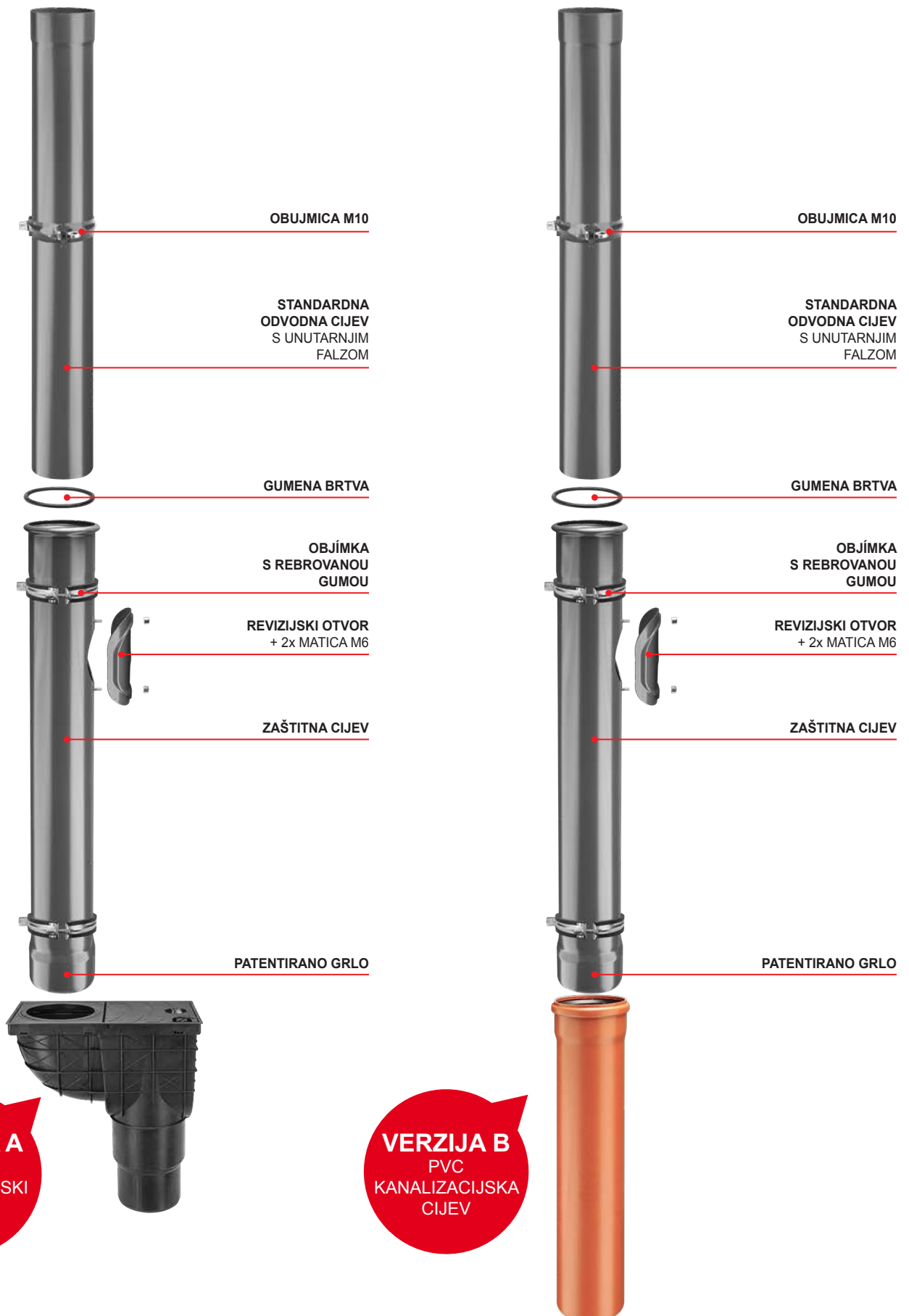

I. OPĆE ODREDBE

- 1.1. Trgovačko društvo sa sjedištem u Donjem Knežincu (Općina Gornji Knežinec), Ulica Kralja Andrije II 4, OIB: 73220465365, zastupano po direktoru Eduardu Kollaru ml. (dalje u tekstu: Prodavatelj) objavljuje ove Opće uvjete poslovanja koji se odnose na kupoprodaju odvodnih sistema kao i lakih krovnih pokriva, trapeza, limova krovne opreme, alata, strojeva i ostale robe vezane za krovne sisteme te drugu robu iz prodajno proizvodnog asortimana Prodavatelja (dalje u tekstu: Roba).
- 1.2. Opći uvjeti čine sastavni dio ugovora o kupoprodaji između pojedinog kupca i društva KJG d.o.o. sa sjedištem u Donjem Knežincu (Općina Gornji Knežinec), Ulica Kralja Andrije II 4, OIB: 73220465365, zastupano po direktoru Eduardu Kollaru ml. kao prodavatelja nastao ugovorenim kupnjom pojedinog proizvoda iz proizvodno-prodajnog asortimana Prodavatelja.
- 1.3. Ovim općim uvjetima reguliraju se međusobna prava i obveze u svrhu neometenog i brzog poslovanja između Kupca i Prodavatelja, a koje će nastati s osnovu kupoprodaje proizvoda iz asortimana Prodavatelja.
- 1.4. Prodavatelj prodaje i isporučuje robu samo u skladu s ovim Općim uvjetima.
- 1.5. U slučajevima naručivanja specifičnih, nestandardnih proizvoda s Kupcem se ugovaraju posebni uvjeti prodaje i plaćanja. Svaka izmjena mora biti sastavljena u pisanoj formi i potpisana od odgovornih osoba ugovornih strana.
- 1.6. Ovi opći uvjeti zajedno s pisanom prihvatom ponude Kupca čine ugovor.

II. PONUDE, NARUŽBA I CIJENE I SKLAPANJE UGOVORA

- 2.1. Ponuda Prodavatelja zasniva se na važećim cjenicima i katalogima proizvoda Prodavatelja. Kupac je isključivo odgovoran za ispravan odabir vrste proizvoda i njihove količine.
- 2.2. Ponuda Prodavatelja može biti prihvaćena samo pisanim putem.
- 2.3. Pisana i ovjerena narudžba Kupca smatra se temeljem za sklapanje ugovora o kupoprodaji.
- 2.4. Narudžba Kupca mora sadržavati:
 - * tvrtku, sjedište, OIB i odgovornu osobu Kupca
 - * specifikaciju naručene robe (tip, vrsta, količina i dimenzija), mjesto isporuke, težinu i način isporuke
 - * datum narudžbe,
 - * ime i prezime, funkciju osobe koja je ovlaštena preuzeti robu za Kupca
 - * u slučaju da se naručena roba, po nalogu Kupca, ima isporučiti trećoj osobi, takav nalog mora biti naznačen na narudžbi s točnom naznakom imena i adrese treće osobe, s time da se potpis i štambilj treće osobe na otpremnici Prodavatelja uzima kao potvrda da je roba isporučena Kupcu
- 2.5. Stranke će posebnim pogodbama ugovoriti rokove plaćanja, limite, vrijeme i način isporuke robe i druge međusobne obveze i prava pojedinog poslovnog odnosa.
- 2.6. Nakon što se stranke usuglase o posebnim pogodbama, ugovor o kupoprodaji se smatra sklopljenim u trenutku ovjere narudžbe od strane Prodavatelja

III. CIJENA I NAČIN PLAĆANJA

- 3.1. Kupac se obvezuje Prodavatelju naručenu robu platiti u ugovorenom roku i ugovorenoj prodajnoj cijeni. Prodajna cijena utvrđuje se prema cjeniku Prodavatelja (cijene su bez PDV-a) na dan narudžbe. Ukupna cijena narudžbe sa uključenim PDV-om biti će navedena prilikom ovjere narudžbe od strane Prodavatelja.
- 3.2. Na vrijednost robe koja se prodaje inozemnom kupcu (izvoz) ne obračunava se PDV.
- 3.3. Limit dugovanja ugovorne strane ugovaraju posebnim pogodbama.
- 3.4. U slučaju prekoračenja odobrenog limita ili prekoračenja ugovorenih rokova plaćanja Prodavatelj je ovlašten obavijestiti daljnju isporuku robe, sve dok dugovanje Kupca ne padne ispod dozvoljenog limita, odnosno, dok Kupac ne plati dospjele račune, ili dok Kupac ne preda Prodavatelju odgovarajuće jamstvo.
- 3.5. Plaćanjem na vrijeme se smatra isključivo kada je uplata vidljiva na računu Prodavatelja ili ako se uplata na dan dospjeća izvrši gotovinom na blagajni Prodavatelja
- 3.6. Ukoliko Kupac ne plati ispostavljeni račun u roku, Prodavatelj ima pravo obračunati zakonsku zateznu kamatu

IV. ISPORUKA ROBE I ZADRŽAVANJE PRAVA VLASNIŠTVA

- 4.1. Prodavatelj je dužan Kupcu isporučiti robu u ugovorenom roku.
- 4.2. Prodavatelj je dužan Kupcu isporučiti robu kvalitete izrade prikladne za svrhu u koju će se roba koristiti.
- 4.3. Kupac je dužan naručenu i isporučenu robu preuzeti.
- 4.4. Prodavatelj je dužan robu zapakirati i organizirati prijevoz na način na koji je to za naručenu robu uobičajeno i predviđeno – osim ukoliko se stranke drugačije ne dogovore.
- 4.5. Isporuka robe se obavlja u vrijeme i na način koji je definiran posebnim pogodbama.
- 4.6. Ukoliko se roba preuzima u sjedištu Prodavatelja, osoba koja preuzima robu u ime i za račun Kupca dužna je skladišnom radniku Prodavatelja dokazati pravo na preuzimanje robe
- 4.7. Prilikom dostave na adresu Kupca Kupac je dužan ovjeriti otpremnicu kao znak da je roba doista preuzeta
- 4.8. Kupac je dužan ovjeriti čitljivim potpisom osobe preuzimatelja robe i štambiljem Kupca svaku otpremnicu kao znak da je roba doista isporučena i preuzeta
- 4.9. U slučaju da roba mora biti dostavljena na adresu Kupca, Prodavatelj će naplatiti dostavu po važećem cjeniku na dan narudžbe. Također, Prodavatelj zadržava pravo isporučiti robu na pristupačnom terenu.
- 4.10. Za robu koja se šalje poštom, Prodavatelj će Kupcu naplatiti troškove poštarine, osim ako nije drugačije dogovoreno.
- 4.11. Kupac se obavezuje preuzeti robu u ugovorenom roku, u suprotnom ulazi u zakašnjenje. U slučaju da Kupac ne ispuni svoju obavezu, Prodavatelj ga može pozvati na ispunjenje svoje obaveze u dodatnom roku. Ako Kupac ne podigne robu niti u dodatnom roku Prodavatelj je ovlašten raskinuti ugovor.
- 4.12. Prodavatelj zadržava sva vlasnička prava na robu koju isporučuje, sve dok Kupac u potpunosti ne plati ugovorenu cijenu.

V. OBUSTAVA ISPORUKE

- 5.1. Ukoliko Kupac ne ispuni jednu ili više svojih obveza ili to ne obavi ispravno i u skladu sa ugovorom primjenjuje se slijedeće:
 - * Obveze Prodavatelja se automatizmom i bez odgode obustavljaju sve dok Kupac ne podmiri svoja dugovanja (uključivo plaćanje sudskih i van sudskih troškova)
 - * Prodavatelj može zahtijevati potpunu isplatu i/ili odgovarajuće jamstvo Kupca (npr. bankarska garancija)
- 5.2. Prodavatelj ima pravo zatražiti od Kupca isplatu i/ili odgovarajuće jamstvo plaćanja ukoliko postoji opravdana sumnja da Kupac neće ili ne može ispuniti svoje obveze u ugovorenom roku

VI. RIZIK

- 6.1. Do predaje robe Kupcu rizik slučajne propasti ili oštećenja stvari snosi Prodavatelj, a s predajom stvari rizik prelazi na Kupca.
- 6.2. Ako je prodavatelj dužan poslati robu Kupcu, mora sklopiti na uobičajeni način i pod uobičajenim uvjetima ugovore potrebne za izvršenje prijevoza do određenog mjesta, s time da rizik od slučajne propasti ili oštećenja prelazi na Kupca u trenutku predaje robe poštanskoj službi.
- 6.3. Ako robu Kupac preuzima na skladištu Prodavatelja (osobno ili putem prijevoznika) rizik od slučajne propasti ili oštećenja prelazi na Kupca u trenutku predaje robe bilo Kupcu bilo prijevozniku.
- 6.4. Kupac je dužan bez odgode primljenu robu na uobičajeni način pregledati ili je dati na pregled.

VII. ODGOVORNOST ZA NEDOSTATKE I JAMSTVO

- 7.1. Prodavatelj odgovara za materijalne nedostatke robe koje je ona imala u trenutku prijelaza rizika na kupca, bez obzira je li mu to bilo poznato.
- 7.2. Prodavatelj odgovara i za one materijalne nedostatke koji se pojave nakon prijelaza rizika na Kupca, ukoliko Kupac može dokazati da su nedostaci posljedica uzroka koji je postojao prije prijelaza rizika
- 7.3. Kupac je dužan obavijestiti Prodavatelja o vidljivim nedostacima na primljenoj robu bez odgađanja.
- 7.4. Kad se nakon primitka robe od strane Kupca pokaže da roba ima neki nedostatak koji se nije mogao otkriti uobičajenim pregledom prilikom preuzimanja stvari, Kupac je dužan, pod prijetnjom gubitka prava, o tom nedostaku obavijestiti Prodavatelja bez odgađanja
- 7.5. Nedostaci se moraju opisati na način da ih Prodavatelj može provjeriti. Zbog toga Kupac mora voditi evidenciju o korištenju robe, a u slučaju preprodaje robe, isto je dužan zatražiti od svojih kupaca.
- 7.6. Kupac je dužan ograničiti na najmanju moguću mjeru štete na isporučenoj robi, za koju podnosi reklamaciju Prodavatelju.
- 7.7. Prodavatelj ne odgovara za nedostatke koji se pokažu pošto protekne jedan mjesec od primitka robe
- 7.8. Ako Prodavatelj jamči za ispravnost stvari u tijeku određenog vremena (jamstvo), postupak reklamacije biti će definiran posebnim jamstvenim listom
- 7.9. Jamstveni rok teče do dana preuzimanja robe. Ako Prodavatelj dostavlja robu Kupcu, jamstveni rok počinje teći od datuma kada je roba dostavljena na odredište. Jamstveni rok se produljuje za razdoblje u kojem Kupac ne može koristiti robu zbog nedostataka za koje odgovara Prodavatelj.
- 7.10. Ako Prodavatelj jamči za ispravnost robe u tijeku određenog vremena, računajući od njezine predaje Kupcu, Kupac može, ako roba nije ispravna, zahtijevati od Prodavatelja da stvar popravi u razumnom roku ili, ako to ne učini, da mu umjesto nje preda ispravnu stvar.
- 7.11. Kupci koji su ostvarili određeni rabat na nabavnu cijenu robe, nemaju pravo na naknadu zbog izgubljene zarade uslijed nedostatka na primljenoj robi

VIII. VIŠA SILA

- 8.1. Viša sila podrazumijeva okolnosti u kojima je ispunjenje obveza nemoguće ili nerazmjerno otežano, a koje se ne mogu pripisati Prodavatelju. Takve okolnosti mogu uključivati štrajkove, požare, ekstremne klimatske uvjete, vladine mjere, kao i nedostatke u proizvodima isporučenicima Prodavatelju, te druge vanjske, izvanredne i nepredvidive okolnosti nastale poslije sklapanja ugovora.
- 8.2. Svaka ugovorna strana dužna je bez odgode obavijestiti drugu o nastupu okolnosti iz prethodnog članka.
- 8.3. Ukoliko okolnosti nastale djelovanjem više sile traju duže od 30 dana, obje strane imaju pravo raskinuti ugovor. U tom slučaju Prodavatelj ne odgovara za štetu Kupcu.

IX. ZAŠTITA OSOBNIH PODATAKA

- 9.1. Prodavatelj radi brže poslovne komunikacije s Kupcem može za obradu poslovne dokumentacije i poslovnih događanja koristiti računalnu obradu podataka. S tim u vezi Prodavatelj jamči Kupcu da će sve podatke koji su mu posljedjeni u svrhu poslovanja koristiti isključivo u opsegu potrebnom za obradu podataka.
- 9.2. Kupac daje Prodavatelju suglasnost za upotrebu podataka Kupca u svrhu:
 - a/ ostvarivanja prava i obveza koja proizlaze i kupoprodajnog odnosa
 - b/ vođenja evidencije obveza Kupca prema Prodavatelju
 - c/ provođenja marketinških aktivnosti

X. RJEŠAVANJE SPOROVA

- 10.1. Sve sporove koji bi proizašli iz ovih Uvjeta ili u vezi s njima, odnosno iz ugovora između Prodavatelja i Kupca ili u vezi s njima, uključujući i sporove koji se odnose na pitanja njihova valjana nastanka, povrede ili prestanka, kao i na pravne učinke koji iz toga proistječu, stranke će pokušati riješiti mirnim putem, no, ukoliko to ne bude moguće za rješavanje nastalih sporova biti će nadležan stvarno nadležni sud u Varaždinu.

XI. SALVATORSTA KLAUZULA

- 11.1. Ako bilo koja od odredbi ovih Općih uvjeta postane ništeta, ta će se odredba zamijeniti valjanom odredbom, koja u što većoj mjeri odgovara sadržaju i trgovačkom cilju koji su ugovorne strane htjele postići ranijom odredbom koja je proglašena ništetnom. Ukoliko ima više ništetnih odredbi, ova klauzula se primjenjuje na svaku ništetnu odredbu.
- 11.2. U tom slučaju ostale odredbe Općih uvjeta ostaju na snazi.

XII. ZAVRŠNE ODREDBE

- 12.1. Kupac nema pravo prenijeti svoja prava definirana ugovorom o kupoprodaji trećoj strani bez pismenog pristanka Prodavatelja
- 12.2. Uvjeti kupoprodaje koji se utvrđuju posebnim pogodbama moguće je mijenjati isključivo pismenim pute, zaključenjem Anexa ugovoru, koji je potpisani ovjeren od obje ugovornih strana
- 12.3. Kupac potvrđuje da je upoznat s ovim Općim uvjetima, da je pročitao Opće uvjete, da pristaje na njihovu primjenu, te da prihvaća sva prava i obveze koje proistječu iz ovih uvjeta