



ŽLEBNI SISTEM POLKROŽNI



CENIK
2023

PRIPOROČENA PRODAJNA CENA



POWERFUL PARTNER FOR YOUR ROOF



Aluminij material | 4



Žleb | 6



Strešni dilatacijski žleb | 9



Žleb oprema | 13



Kljuka | 15



Vogalnik | 18



Zaključek žleba | 20



Kotliček | 21



Koleno | 32



Cev odvodna | 35



Cev odvodna oprema | 40



Objemka | 42

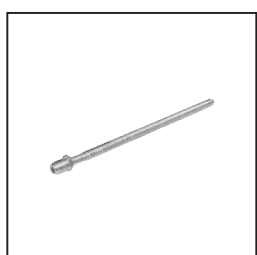

Objemka oprema | 43



Lovilec vode | 45



Zaščitna cev | 49

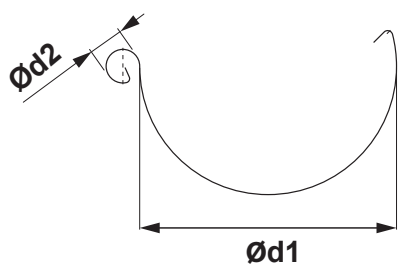

DIMENZIJE STREŠNIH ŽLEBOV

(dimenzije in toleranca po EN 612)

Razvita širina (mm)	200	250	280	333	400
Ød1	80	105	127	153	192
Ød2	16	18	18	20	22

NOTRANJI ZGIB

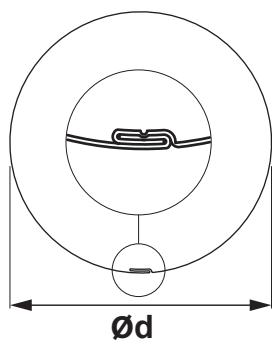

DIMENZIJE STREŠNIH ODOČNIH CEVI

(dimenzije in toleranca po EN 612)

Dimenzije	60	80	100	120	150
Imenska velikost Ød (mm)	60	80	100	120	150

DIMENZIJE STREŠNIH KAVLJEV

(dimenzije in toleranca po EN 612)

Dimenzije (mm)	L1	Ød
250	310	105
280	337	127
333 – 550	385	153
333 – 650	485	153
400	436	192

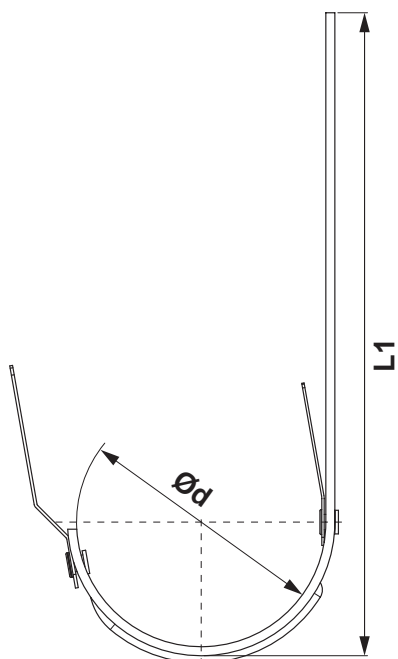

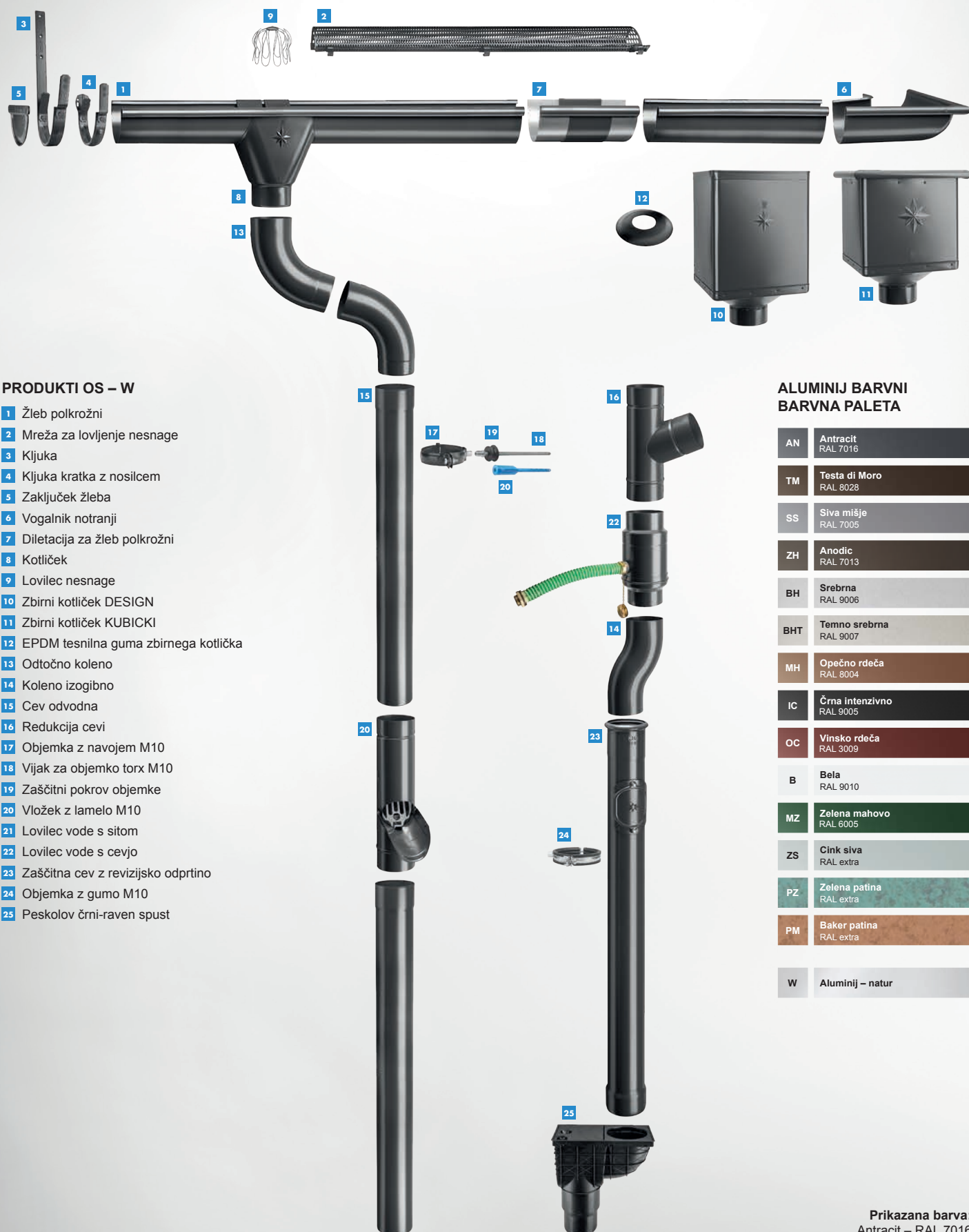

PRODUKTI OS – W

- 1 Žleb polkrožni
- 2 Mreža za lovljenje nesnage
- 3 Kljuka
- 4 Kljuka kratka z nosilcem
- 5 Zaključek žleba
- 6 Vogalnik notranji
- 7 Diletacija za žleb polkrožni
- 8 Kotliček
- 9 Lovilec nesnage
- 10 Zbirni kotliček DESIGN
- 11 Zbirni kotliček KUBICKI
- 12 EPDM tesnilna guma zbirnega kotlička
- 13 Odtočno koleno
- 14 Koleno izogibno
- 15 Cev odvodna
- 16 Redukcija cevi
- 17 Objemka z navojem M10
- 18 Vijak za objemko torx M10
- 19 Zaščitni pokrov objemke
- 20 Vložek z lamelo M10
- 21 Lovilec vode s sitom
- 22 Lovilec vode s cevjo
- 23 Zaščitna cev z revizijsko odprtino
- 24 Objemka z gumo M10
- 25 Peskolov črni-raven spust

ALUMINIJ BARVNI BARVNA PALETA

AN	Antracit RAL 7016
TM	Testa di Moro RAL 8028
SS	Siva mišje RAL 7005
ZH	Anodic RAL 7013
BH	Srebrna RAL 9006
BHT	Temno srebrna RAL 9007
MH	Opečno rdeča RAL 8004
IC	Črna intenzivno RAL 9005
OC	Vinsko rdeča RAL 3009
B	Bela RAL 9010
MZ	Zelena mahovo RAL 6005
ZS	Cink siva RAL extra
PZ	Zelena patina RAL extra
PM	Baker patina RAL extra
W	Aluminij – natur



ALUMINIUM POLYESTER + NATUR

NOVELIS

Je ameriška industrijska družba za proizvodnjo aluminija s sedežem v Atlanti v ameriški državi Georgia. Gre za hčerinsko družbo indijskega proizvajalca aluminija in bakra Hindalco Industries. Novelis je vodilni proizvajalec valjanega aluminija in globalni lider na področju predelave pločevink. Družba nudi storitve kupcem v različnih panogah, vključno s pločevinkami za pijače, izdelki za avtomobilsko industrijo, elektroniko, gradbeništvo, folije in embalažo.

ADITYA BIRLA



SPEIRA

Speira je globalna družba za valjanje in predelavo aluminija. Sestavljena je iz raziskovalno-razvojnega centra in sedmih proizvodnih obratov. Obrati se nahajajo v Nemčiji in na Norveškem. Tam deluje tudi našo skupno podjetje Alunorf, ki je največja valjana aluminija na svetu, in podjetje Grevenbroich, ki je največja valjana za finalizacijo aluminjskih izdelkov na svetu ter nekaj mednarodnih komercialnih pisarn. Speira zaposluje okoli 5 000 delavcev, zlasti v Nemčiji in na Norveškem.

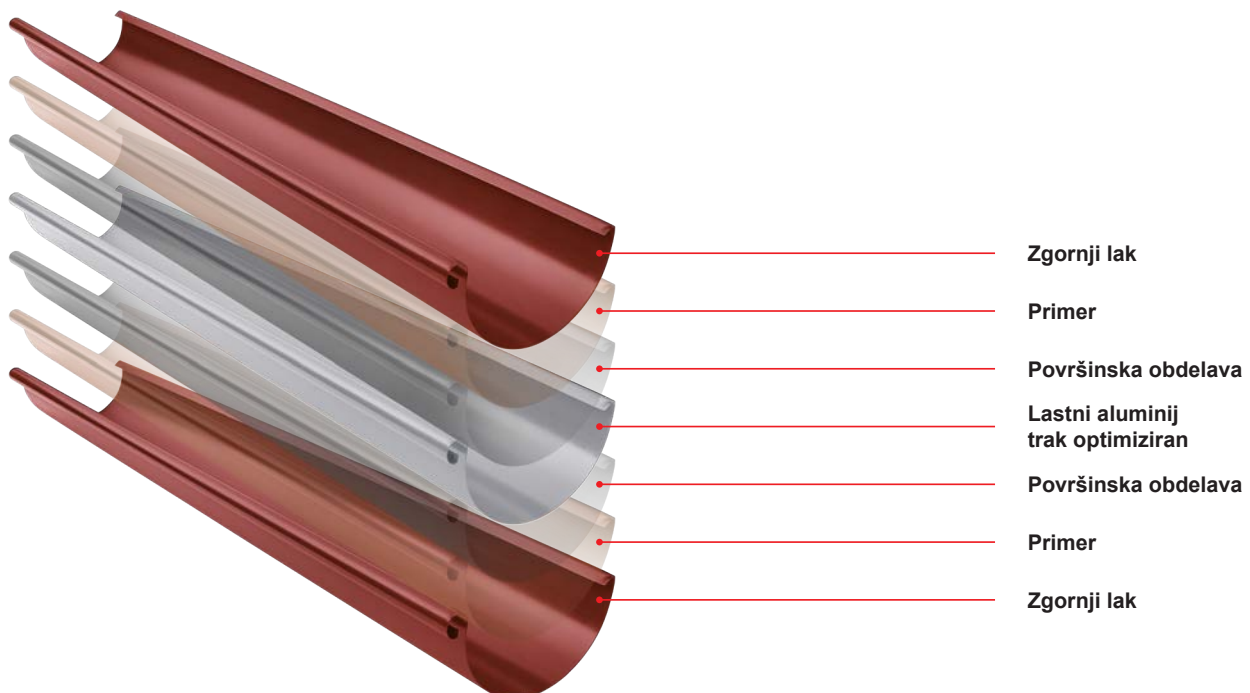

ALUMINIUM POLYESTER + NATUR

ŽLEB POLKROŽNI [s=0,70]

W-WZ

Nominalna velikost	200		250		250		280		280	
Dolžina v m	3,0		4,0		6,0		4,0		6,0	
Cena v €/m	Brez DDV	Z DDV	Brez DDV	Z DDV	Brez DDV	Z DDV	Brez DDV	Z DDV	Brez DDV	Z DDV
AN 1 Antracit RAL 7016	6,05	7,38	4,95	6,04	4,95	6,04	6,30	7,69	6,30	7,69
	051066 *		051073		051080		051097		051103	
TM 2 Testa di Moro RAL 8028	6,05	7,38	4,95	6,04	4,95	6,04	6,30	7,69	6,30	7,69
	051707 *		051714		051721		051738		051745	
SS 3 Siva mišje RAL 7005			4,95	6,04	4,95	6,04	6,30	7,69	6,30	7,69
			051639		051646		051653		051660	
ZH 4 Anodic RAL 7013			4,95	6,04	4,95	6,04	6,30	7,69	6,30	7,69
			051790		051806		051813		051820	
BH 5 Srebrna RAL 9006			4,95	6,04	4,95	6,04	6,30	7,69	6,30	7,69
			051233		051240 *		051257		051264	
BHT 6 Temno srebrna RAL 9007			4,95	6,04	4,95	6,04	6,30	7,69	6,30	7,69
			101891 *		101907 *		101914 *		101921 *	
MH 7 Opečno rdeča RAL 8004			4,95	6,04	4,95	6,04	6,30	7,69	6,30	7,69
			051394		051400		051417		051424	
IC 8 Črna intenzivno RAL 9005			4,95	6,04	4,95	6,04	6,30	7,69	6,30	7,69
			051318		051325 *		051332		051349 *	
OC 9 Vinsko rdeča RAL 3009			4,95	6,04	4,95	6,04	6,30	7,69	6,30	7,69
			051554		051561		051578		051585	
B 10 Bela RAL 9010			4,95	6,04	4,95	6,04	6,30	7,69	6,30	7,69
			051158		051165		051172		051189	
MZ 11 Zelena mahovo RAL 6005			4,95	6,04	4,95	6,04	6,30	7,69	6,30	7,69
			051479		051486		051493		051509	
ZS 12 Cink siva RAL extra			4,95	6,04	4,95	6,04	6,30	7,69	6,30	7,69
			051875		051882 *		051899 *		051905 *	
PZ 13 Zelena patina RAL extra										
PM 14 Baker patina RAL extra										
Aluminij 15 Natur			4,70	5,73	4,70	5,73	5,40	6,59	5,40	6,59
			049957		049964		049971		049988	
Pakiranje v m	15		20		30		20		30	
Pakiranje v m	1 200		960		1 440		840		1 260	

* Izdelava po meri

ALUMINIUM
POLYESTER + NATUR



ŽLEB POLKROŽNI [s=0,70]

W-WZ

Nominalna velikost	333		333		400	
Dolžina v m	4,0		6,0		6,0	
Cena v €/m	Brez DDV	Z DDV	Brez DDV	Z DDV	Brez DDV	Z DDV
AN 1 Antracit RAL 7016	6,45	7,87	6,45	7,87	9,40	11,47
	051110		051127		051134	
TM 2 Testa di Moro RAL 8028	6,45	7,87	6,45	7,87	9,40	11,47
	051752		051769		051776 *	
SS 3 Siva mišje RAL 7005	6,45	7,87	6,45	7,87	9,40	11,47
	051677		051684		051691	
ZH 4 Anodic RAL 7013	6,45	7,87	6,45	7,87	9,40	11,47
	051837		051844		051851	
BH 5 Srebrna RAL 9006	6,45	7,87	6,45	7,87	9,40	11,47
	051271		051288		051295	
BHT 6 Temno srebrna RAL 9007	6,45	7,87	6,45	7,87	9,40	11,47
	101938		101945		070104 *	
MH 7 Opečno rdeča RAL 8004	6,45	7,87	6,45	7,87	9,40	11,47
	051431		051448		051455 *	
IC 8 Črna intenzivno RAL 9005	6,45	7,87	6,45	7,87	9,40	11,47
	051356		051363		051370 *	
OC 9 Vinsko rdeča RAL 3009	6,45	7,87	6,45	7,87	9,40	11,47
	051592		051608		051615 *	
B 10 Bela RAL 9010	6,45	7,87	6,45	7,87	9,40	11,47
	051196		051202		051219 *	
MZ 11 Zelena mahovo RAL 6005	6,45	7,87	6,45	7,87	9,40	11,47
	051516		051523		051530	
ZS 12 Cink siva RAL extra	6,45	7,87	6,45	7,87	9,40	11,47
	051912		051929		051936 *	
PZ 13 Zelena patina RAL extra	9,00	10,98	9,00	10,98		
	112781 *		112798			
PM 14 Baker patina RAL extra	9,00	10,98	9,00	10,98		
	112767 *		112774			
Aluminij 15 Natur	6,05	7,38	6,05	7,38	8,10	9,88
	049995		050007		050014	
Pakiranje v m 	20		30		30	
Pakiranje v m 	660		990		810	

* Izdelava po meri



ŽLEB LEŽEČI [s=0,70]

W-WZS

Nominalna velikost	650		700		700	
Dolžina v m	6,0		4,0		6,0	
Cena v €/m	Brez DDV	Z DDV	Brez DDV	Z DDV	Brez DDV	Z DDV
AN 1 Antracit RAL 7016			23,00	28,06	23,00	28,06
			049193		049209	
TM 2 Testa di Moro RAL 8028	17,10	20,86				
	049308 *					
SS 3 Siva mišje RAL 7005			23,00	28,06	23,00	28,06
			049285 *		049292	
ZH 4 Anodic RAL 7013			23,00	28,06	23,00	28,06
			049315		049322	
BH 5 Srebrna RAL 9006	17,10	20,86				
	049223 *					
BHT 6 Temno srebrna RAL 9007	17,10	20,86				
	101990 *					
MH 7 Opečno rdeča RAL 8004	17,10	20,86				
	049247 *					
IC 8 Črna intenzivno RAL 9005	17,10	20,86				
	049230 *					
OC 9 Vinsko rdeča RAL 3009	17,10	20,86				
	049278 *					
B 10 Bela RAL 9010	17,10	20,86				
	049216 *					
MZ 11 Zelena mahovo RAL 6005			23,00	28,06	23,00	28,06
			049254		049261	
ZS 12 Cink siva RAL extra	17,10	20,86				
	049339 *					
PZ 13 Zelena patina RAL extra						
PM 14 Baker patina RAL extra						
Aluminij 15 Natur	15,50	18,91				
	049186 *					
Pakiranje v m 	6		4		6	
Pakiranje v m 	300		200		300	

* Izdelava po meri



DILETACIJA ZA ŽLEB POLKROŽNI

W-WZDI

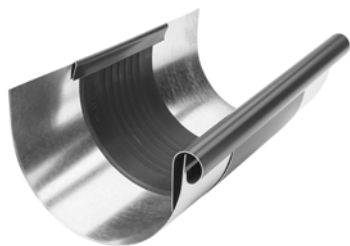

Nominalna velikost	250/260		285/260		333/260		400/260	
	Brez DDV	Z DDV	Brez DDV	Z DDV	Brez DDV	Z DDV	Brez DDV	Z DDV
AN 1 Antracit RAL 7016	20,50	25,01	21,50	26,23	21,50	26,23	27,00	32,94
	028341 *		028358 *		028365		028372	
TM 2 Testa di Moro RAL 8028	20,50	25,01	21,50	26,23	21,50	26,23	27,00	32,94
	028662 *		028679 *		028686		028693 *	
SS 3 Siva mišje RAL 7005	20,50	25,01	21,50	26,23	21,50	26,23	27,00	32,94
	028624 *		028631 *		028648 *		028655 *	
ZH 4 Anodic RAL 7013	20,50	25,01	21,50	26,23	21,50	26,23	27,00	32,94
	028709 *		028716 *		028723 *		028730 *	
BH 5 Srebrna RAL 9006	20,50	25,01	21,50	26,23	21,50	26,23	27,00	32,94
	028426 *		028433 *		028440		028457	
BHT 6 Temno srebrna RAL 9007	20,50	25,01	21,50	26,23	21,50	26,23	27,00	32,94
	101440 *		101457 *		101464 *		070135 *	
MH 7 Opečno rdeča RAL 8004	20,50	25,01	21,50	26,23	21,50	26,23	27,00	32,94
	028501 *		028518 *		028525 *		028532 *	
IC 8 Črna intenzivno RAL 9005	20,50	25,01	21,50	26,23	21,50	26,23	27,00	32,94
	028464 *		028471 *		028488 *		028495 *	
OC 9 Vinsko rdeča RAL 3009	20,50	25,01	21,50	26,23	21,50	26,23	27,00	32,94
	028587 *		028594 *		028600 *		028617 *	
B 10 Bela RAL 9010	20,50	25,01	21,50	26,23	21,50	26,23	27,00	32,94
	028389 *		028396 *		028402 *		028419 *	
MZ 11 Zelena mahovo RAL 6005	20,50	25,01	21,50	26,23	21,50	26,23	27,00	32,94
	028549 *		028556 *		028563 *		028570 *	
ZS 12 Cink siva RAL extra	20,50	25,01	21,50	26,23	21,50	26,23	27,00	32,94
	028747 *		028754 *		028761 *		028778 *	
PZ 13 Zelena patina RAL extra					32,50	39,65		
					112590 *			
PM 14 Baker patina RAL extra					32,50	39,65		
					112583 *			
Aluminij 15 Natur	22,70	27,69	23,60	28,79	25,50	31,11	31,70	38,67
	028303 *		028310 *		028327 *		028334 *	
Pakiranje v kos 	3		3		5		5	
Pakiranje v kos 	360		360		200		200	

* Izdelava po meri



DILETACIJA ZA LEŽEČI ŽLEB

W-WZSDI

Nominalna velikost	670/260	
Cena v €/kos	Brez DDV	Z DDV
AN 1 Antracit RAL 7016	65,00	79,30
		029157 *
TM 2 Testa di Moro RAL 8028	65,00	79,30
		029232 *
SS 3 Siva mišje RAL 7005	65,00	79,30
		029225 *
ZH 4 Anodic RAL 7013	65,00	79,30
		029249 *
BH 5 Srebrna RAL 9006	65,00	79,30
		029171 *
BHT 6 Temno srebrna RAL 9007	65,00	79,30
		101471 *
MH 7 Opečno rdeča RAL 8004	65,00	79,30
		029195 *
IC 8 Črna intenzivno RAL 9005	65,00	79,30
		029188 *
OC 9 Vinsko rdeča RAL 3009	65,00	79,30
		029218 *
B 10 Bela RAL 9010	65,00	79,30
		029164 *
MZ 11 Zelena mahovo RAL 6005	65,00	79,30
		029201 *
ZS 12 Cink siva RAL extra	65,00	79,30
		029256 *
PZ 13 Zelena patina RAL extra		
PM 14 Baker patina RAL extra		
Aluminij 15 Natur	58,50	71,37
		029140 *
Pakiranje v kos 		1
Pakiranje v kos 		40



* Izdelava po meri





DILETACIJSKI TRAK

W-WZDIP

Nominalna velikost	Dolžina v m	EAN številko izdelka	Pakiranje v m		Cena [€/m]	
					Brez DDV	Z DDV
260	3,0	028181	3	120	40,00	48,80

UPORABA DILATACIJSKEGA ŽLEBA IN DILATACIJSKEGA TRAKU

DILATACIJSKI ŽLEB

Primer montaže: Razvite širine do 500 mm. Dilatacijski žleb mora biti nameščen z razmikom 15 m. Za zunanji vogal in začetek žleba velja polovica standardne vrednosti: največ 7,5 m. Za notranji vogal velja četrtnina standardne vrednosti: največ 3,75 m. Za druge materiale in dimenzije: glej tabelo spodaj. Vogali vedno štejejo kot fiksne točke.

DILATACIJSKI TRAK

Notranja namestitvev: na žlebove pritrjen brez lepljenja na podlago, strehe z nestandardnim profilom in pločevinsko obrobo zidov

STREŠNI POLOGLATI DILATACIJSKI ŽLEBOVI

Razvita širina žleba	Aluminij	Pocinkano, Cinkotit, Baker, Inox
< 500	12	15
> 500	8	10

STREŠNI DILATACIJSKI TRAK

Razvita širina žleba	Aluminij	Pocinkano, Cinkotit, Baker, Inox
< 500	8	10
> 500	6	8

Za zunanji vogal ali začetek žleba velja polovica standardne vrednosti. Za notranji vogal velja ena četrtnina standardne vrednosti.

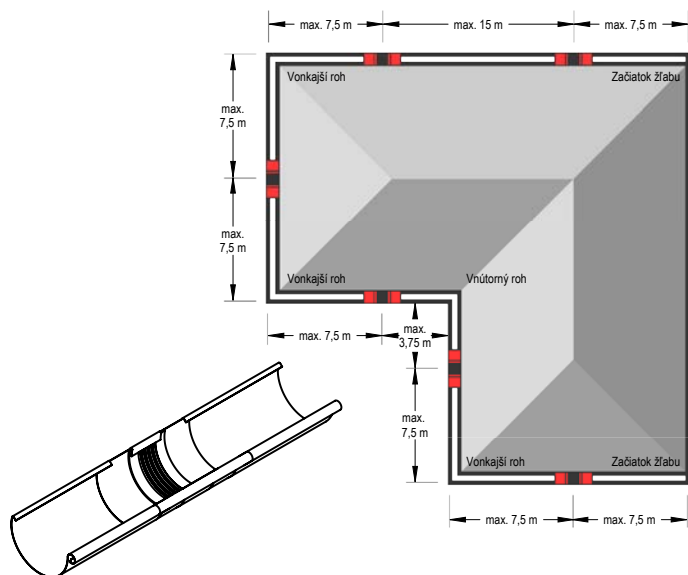

Opomba za montažo dilatacijskega žleba

Pri montaži s spajkanjem najprej srednji gumijasti del pokrijte z mokro krpo (da ne pride do prehoda toplotev srednji gumijasti del). Upoštevati je potrebno minimalno razdaljo 6 cm od srednjega gumijastega dela. V vsakem primeru se izogibajte kontaktu gume z odprtim ognjem.

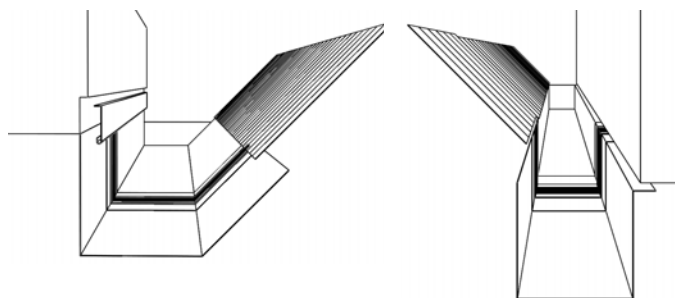



Opomba za montažo dilatacijskega traku

Pri krivljenju in montaži dilatacijskih elementov preverite, ali:

- je radij čeljusti za krivljenje vsaj 2 mm.
- Za debelino pločevine od 1 mm mora biti polmer krivljenja vsaj 5 mm.
- Čeljusti morajo biti za krivljenje nastavljene v debelini srednjega gumijastega dela 3 do 4 mm, da se prepreči učinek rezanja – poškodovanja gume.
- Gumijasti srednji del ne sme biti med krivljenjem stisnjen ali poškodovan. Zato je treba uporabiti aluminijški pločevinski trak 2 do 5 mm (debeline) ukrivljen tako, da se lahko pritrdi kot zaščita na čeljusti. Tako dosežete večji polmer krivljenja in preprečite poškodovanje gumijastega srednjega dela.

MREŽA ZA LOVLJENJE NESNAGE

W-WZNLM

Nominalna velikost	333	
Dolžina v m	2,0	
Cena v €/kos	Brez DDV	Z DDV
AN 1 Antracit RAL 7016	26,50	32,33
	064950	
TM 2 Testa di Moro RAL 8028	26,50	32,33
	064981 *	
SS 3 Siva mišje RAL 7005	26,50	32,33
	064974	
ZH 4 Anodic RAL 7013	26,50	32,33
	118127 *	
BH 5 Srebna RAL 9006	26,50	32,33
	118080 *	
BHT 6 Temno srebna RAL 9007	26,50	32,33
	118097 *	
MH 7 Opečno rdeča RAL 8004	26,50	32,33
	118103 *	
IC 8 Črna intenzivno RAL 9005	26,50	32,33
	118059	
OC 9 Vinsko rdeča RAL 3009	26,50	32,33
	118066 *	
B 10 Bela RAL 9010	26,50	32,33
	118134 *	
MZ 11 Zelena mahovo RAL 6005	26,50	32,33
	118110 *	
ZS 12 Cink siva RAL extra	26,50	32,33
	118073 *	
PZ 13 Zelena patina RAL extra		
PM 14 Baker patina RAL extra		
Aluminij 15 Natur	25,50	31,11
	064905	
Pakiranje v kos 	15	
Pakiranje v kos 	120	

* Izdelava po meri

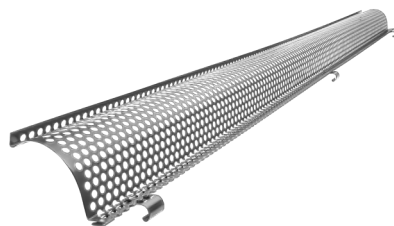



ALUMINIUM POLYESTER + NATUR

PVC MREŽA ZA LOVLJENJE LISTJA

SD-ZNL MREZKA

Nominalna velikost	Dolžina v m	EAN številko izdelka	Pakiranje v kos		Cena [€/kos]	
					Brez DDV	Z DDV
PS 171	1,0	008473	30	450	4,50	5,49
TM 171	1,0	008466	30	450	4,50	5,49

PVC MREŽA ZA LOVLJENJE LISTJA

SD-ZNL N

Nominalna velikost	Dolžina v m	EAN številko izdelka	Pakiranje v kos		Cena [€/kos]	
					Brez DDV	Z DDV
250	3,0	008480	10	400	23,90	29,16
280-333	3,0	008497	10	400	24,00	29,28

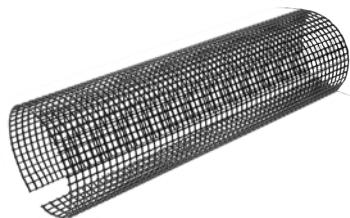
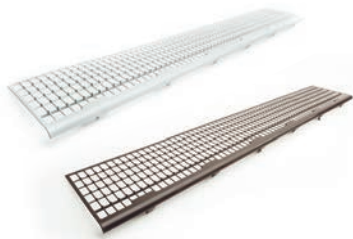

KLJUKA
W-WHP

Nominalna velikost	250/430		280/480		333/550		333/650		400/650		
Material	23/7		28/7		28/7		28/7		30/7		
Cena v €/kos	Brez DDV	Z DDV	Brez DDV	Z DDV	Brez DDV	Z DDV	Brez DDV	Z DDV	Brez DDV	Z DDV	
AN Antracit RAL 7016	1	3,40	4,15	3,90	4,76	4,30	5,25	4,90	5,98	5,20	6,34
		077615		077622		077639		077646		077653	
TM Testa di Moro RAL 8028	2	3,40	4,15	3,90	4,76	4,30	5,25	4,90	5,98	5,20	6,34
		078018		078025		078032		078049		078056	
SS Siva mišje RAL 7005	3	3,40	4,15	3,90	4,76	4,30	5,25	4,90	5,98	5,20	6,34
		077967		077974		077981		077998		078001	
ZH Anodic RAL 7013	4	3,40	4,15	3,90	4,76	4,30	5,25	4,90	5,98	5,20	6,34
		078063		078070		078117		078087		078094	
BH Srebrna RAL 9006	5	3,40	4,15	3,90	4,76	4,30	5,25	4,90	5,98	5,20	6,34
		077714		077738		077721		077745 *		077752	
BHT Temno srebrna RAL 9007	6	3,40	4,15	3,90	4,76	4,30	5,25	4,90	5,98	5,20	6,34
		101488 *		101495 *		101501		101518 *		080264 *	
MH Opečno rdeča RAL 8004	7	3,40	4,15	3,90	4,76	4,30	5,25	4,90	5,98	5,20	6,34
		077813		077820		077837		077844 *		077851	
IC Črna intenzivno RAL 9005	8	3,40	4,15	3,90	4,76	4,30	5,25	4,90	5,98	5,20	6,34
		077769		077776		077783		077790 *		077806	
OC Vinsko rdeča RAL 3009	9	3,40	4,15	3,90	4,76	4,30	5,25	4,90	5,98	5,20	6,34
		077912		077929		077936		077943 *		077950	
B Bela RAL 9010	10	3,40	4,15	3,90	4,76	4,30	5,25	4,90	5,98	5,20	6,34
		077660		077677		077684		077691 *		077707	
MZ Zelena mahovo RAL 6005	11	3,40	4,15	3,90	4,76	4,30	5,25	4,90	5,98	5,20	6,34
		077868		077899		077875		077882		077905	
ZS Cink siva RAL extra	12	3,40	4,15	3,90	4,76	4,30	5,25	4,90	5,98	5,20	6,34
		078124		078100		078131		078148 *		078155 *	
PZ Zelena patina RAL extra	13					9,00	10,98				
						112613					
PM Baker patina RAL extra	14					9,00	10,98				
						112606					
Aluminij Natur	15	3,05	3,72	3,50	4,27	3,85	4,70	4,40	5,37	4,70	5,73
		011930		011947		077585		077592		077608	
Pakiranje v kos		25		25		25		15		20	
Pakiranje v kos		1 000		1 000		1 000		600		800	

* Izdelava po meri



KLJUKA KRATKA Z NOSILCEM

W-WHPK



Nominalna velikost	250		280		333	
Material	28/7		28/7		28/7	
Cena v €/kos	Brez DDV	Z DDV	Brez DDV	Z DDV	Brez DDV	Z DDV
AN 1 Antracit RAL 7016	3,85	4,70	3,90	4,76	3,95	4,82
	011596		011602		011619	
TM 2 Testa di Moro RAL 8028	3,85	4,70	3,90	4,76	3,95	4,82
	011831		011848		011855	
SS 3 Siva mišje RAL 7005	3,85	4,70	3,90	4,76	3,95	4,82
	011800		011817 *		011824	
ZH 4 Anodic RAL 7013	3,85	4,70	3,90	4,76	3,95	4,82
	011862		011879		011886	
BH 5 Srebrna RAL 9006	3,85	4,70	3,90	4,76	3,95	4,82
	011657		011664		011671	
BHT 6 Temno srebrna RAL 9007	3,85	4,70	3,90	4,76	3,95	4,82
	101402 *		101396 *		101389 *	
MH 7 Opečno rdeča RAL 8004	3,85	4,70	3,90	4,76	3,95	4,82
	011718		011725 *		011732	
IC 8 Črna intenzivno RAL 9005	3,85	4,70	3,90	4,76	3,95	4,82
	011688		011695 *		011701	
OC 9 Vinsko rdeča RAL 3009	3,85	4,70	3,90	4,76	3,95	4,82
	011770 *		011787 *		011794	
B 10 Bela RAL 9010	3,85	4,70	3,90	4,76	3,95	4,82
	011626		011633		011640	
MZ 11 Zelena mahovo RAL 6005	3,85	4,70	3,90	4,76	3,95	4,82
	011749		011756		011763	
ZS 12 Cink siva RAL extra	3,85	4,70	3,90	4,76	3,95	4,82
	011893 *		011909 *		011916 *	
PZ 13 Zelena patina RAL extra						
PM 14 Baker patina RAL extra						
Aluminij 15 Natur	3,45	4,21	3,50	4,27	3,55	4,33
	011565		011572		011589	
Pakiranje v kos 	25		25		25	
Pakiranje v kos 	1 000		1 000		1 000	

* Izdelava po meri



KLJUKA ZA LEŽEČI ŽLEB

W-WHSG



Nominalna velikost	4	
Material	28/7	
Cena v €/kos	Brez DDV	Z DDV
AN 1 Antracit RAL 7016	8,95	10,92
		034113
TM 2 Testa di Moro RAL 8028	8,95	10,92
		034199 *
SS 3 Siva mišje RAL 7005	8,95	10,92
		034182
ZH 4 Anodic RAL 7013	8,95	10,92
		034205
BH 5 Srebrna RAL 9006	8,95	10,92
		034137
BHT 6 Temno srebrna RAL 9007	8,95	10,92
		101525 *
MH 7 Opečno rdeča RAL 8004	8,95	10,92
		034151
IC 8 Črna intenzivno RAL 9005	8,95	10,92
		034144 *
OC 9 Vinsko rdeča RAL 3009	8,95	10,92
		034175 *
B 10 Bela RAL 9010	8,95	10,92
		034120 *
MZ 11 Zelena mahovo RAL 6005	8,95	10,92
		034168
ZS 12 Cink siva RAL extra	8,95	10,92
		034212 *
PZ 13 Zelena patina RAL extra		
PM 14 Baker patina RAL extra		
Aluminij 15 Natur	8,05	9,82
		034229 *
Pakiranje v kos 	15	
Pakiranje v kos 	600	

* Izdelava po meri



VOGALNIK NOTRANJI

W-WRA



Nominalna velikost	200		250		280		333		400	
	Brez DDV	Z DDV	Brez DDV	Z DDV	Brez DDV	Z DDV	Brez DDV	Z DDV	Brez DDV	Z DDV
AN 1 Antracit RAL 7016			14,80	18,06	15,50	18,91	16,20	19,76	29,00	35,38
			082220		082237		082244		082251	
TM 2 Testa di Moro RAL 8028			14,80	18,06	15,50	18,91	16,20	19,76	29,00	35,38
			082541		082558		082565		082572 *	
SS 3 Siva mišje RAL 7005			14,80	18,06	15,50	18,91	16,20	19,76	29,00	35,38
			082503		082510		082527		082534	
ZH 4 Anodic RAL 7013			14,80	18,06	15,50	18,91	16,20	19,76	29,00	35,38
			082589		082596		082602		082619 *	
BH 5 Srebrna RAL 9006			14,80	18,06	15,50	18,91	16,20	19,76	29,00	35,38
			082305		082312 *		082329		082336 *	
BHT 6 Temno srebrna RAL 9007			14,80	18,06	15,50	18,91	16,20	19,76	29,00	35,38
			101839 *		101846 *		101853		080295 *	
MH 7 Opečno rdeča RAL 8004			14,80	18,06	15,50	18,91	16,20	19,76	29,00	35,38
			082381		082398		082404		082411 *	
IC 8 Črna intenzivno RAL 9005			14,80	18,06	15,50	18,91	16,20	19,76	29,00	35,38
			082343		082350		082367		082374 *	
OC 9 Vinsko rdeča RAL 3009			14,80	18,06	15,50	18,91	16,20	19,76	29,00	35,38
			082466		082473		082480		082497 *	
B 10 Bela RAL 9010			14,80	18,06	15,50	18,91	16,20	19,76	29,00	35,38
			082268		082275		082282		082299 *	
MZ 11 Zelena mahovo RAL 6005			14,80	18,06	15,50	18,91	16,20	19,76	29,00	35,38
			082428		082435		082442		082459 *	
ZS 12 Cink siva RAL extra			14,80	18,06	15,50	18,91	16,20	19,76	29,00	35,38
			082626		082633		082640		082657 *	
PZ 13 Zelena patina RAL extra							17,70	21,59		
							112736			
PM 14 Baker patina RAL extra							17,70	21,59		
							112729			
Aluminij 15 Natur	13,30	16,23	13,30	16,23	13,95	17,02	14,60	17,81	26,10	31,84
			000514 *		000521		000538		000545	000552 *
Pakiranje v kos 	5		5		5		5		5	
Pakiranje v kos 	150		150		150		150		150	

* Izdelava po meri



VOGALNIK ZUNANJI

W-WRI

Nominalna velikost	200		250		280		333		400	
	Brez DDV	Z DDV	Brez DDV	Z DDV	Brez DDV	Z DDV	Brez DDV	Z DDV	Brez DDV	Z DDV
AN 1 Antracit RAL 7016			14,80	18,06	15,50	18,91	16,20	19,76	29,00	35,38
			081780		081797		081803		081810	
TM 2 Testa di Moro RAL 8028			14,80	18,06	15,50	18,91	16,20	19,76	29,00	35,38
			082107		082114		082121		082138	
SS 3 Siva mišje RAL 7005			14,80	18,06	15,50	18,91	16,20	19,76	29,00	35,38
			082060		082077		082084		082091 *	
ZH 4 Anodic RAL 7013			14,80	18,06	15,50	18,91	16,20	19,76	29,00	35,38
			082145		082152		082169		082176 *	
BH 5 Srebrna RAL 9006			14,80	18,06	15,50	18,91	16,20	19,76	29,00	35,38
			081865 *		081872 *		081889		081896 *	
BHT 6 Temno srebrna RAL 9007			14,80	18,06	15,50	18,91	16,20	19,76	29,00	35,38
			101860 *		101877 *		101884		069221 *	
MH 7 Opečno rdeča RAL 8004			14,80	18,06	15,50	18,91	16,20	19,76	29,00	35,38
			081940		081957		081964		081971 *	
IC 8 Črna intenzivno RAL 9005			14,80	18,06	15,50	18,91	16,20	19,76	29,00	35,38
			081902		081919		081926		081933 *	
OC 9 Vinsko rdeča RAL 3009			14,80	18,06	15,50	18,91	16,20	19,76	29,00	35,38
			082022		082039		082046		082053 *	
B 10 Bela RAL 9010			14,80	18,06	15,50	18,91	16,20	19,76	29,00	35,38
			081827		081834		081841		081858 *	
MZ 11 Zelena mahovo RAL 6005			14,80	18,06	15,50	18,91	16,20	19,76	29,00	35,38
			081988		081995		082008		082015 *	
ZS 12 Cink siva RAL extra			14,80	18,06	15,50	18,91	16,20	19,76	29,00	35,38
			082183		082190		082206		082213 *	
PZ 13 Zelena patina RAL extra							17,70	21,59		
							112750			
PM 14 Baker patina RAL extra							17,70	21,59		
							112743			
Aluminij 15 Natur	13,30	16,23	13,30	16,23	13,95	17,02	14,60	17,81	26,10	31,84
	000569 *		000576 *		000583 *		000590 *		000606 *	
Pakiranje v kos 	5		5		5		5		5	
Pakiranje v kos 	150		150		150		150		150	

* Izdelava po meri



ZAKLJUČEK ŽLEBA

W-WCL



Nominalna velikost	200		250		280		333		400	
	Brez DDV	Z DDV	Brez DDV	Z DDV	Brez DDV	Z DDV	Brez DDV	Z DDV	Brez DDV	Z DDV
AN 1 Antracit RAL 7016	1,50	1,83	1,50	1,83	1,55	1,89	1,60	1,95	2,40	2,93
	085856 *		085863		085870		085887		085894	
TM 2 Testa di Moro RAL 8028	1,50	1,83	1,50	1,83	1,55	1,89	1,60	1,95	2,40	2,93
	086228 *		086235		086242		086259		086266	
SS 3 Siva mišje RAL 7005			1,50	1,83	1,55	1,89	1,60	1,95	2,40	2,93
			086181		086198		086204		086211	
ZH 4 Anodic RAL 7013			1,50	1,83	1,55	1,89	1,60	1,95	2,40	2,93
			086273		086280		086297		086303	
BH 5 Srebrna RAL 9006			1,50	1,83	1,55	1,89	1,60	1,95	2,40	2,93
			085948		085955		085962		085979	
BHT 6 Temno srebrna RAL 9007			1,50	1,83	1,55	1,89	1,60	1,95	2,40	2,93
			101419 *		101426 *		101433		080257 *	
MH 7 Opečno rdeča RAL 8004			1,50	1,83	1,55	1,89	1,60	1,95	2,40	2,93
			086020		086037		086044		086051	
IC 8 Črna intenzivno RAL 9005			1,50	1,83	1,55	1,89	1,60	1,95	2,40	2,93
			085986		085993		086006		086013 *	
OC 9 Vinsko rdeča RAL 3009			1,50	1,83	1,55	1,89	1,60	1,95	2,40	2,93
			086105		086112		086129		086136	
B 10 Bela RAL 9010			1,50	1,83	1,55	1,89	1,60	1,95	2,40	2,93
			085900		085917		085924		085931 *	
MZ 11 Zelena mahovo RAL 6005			1,50	1,83	1,55	1,89	1,60	1,95	2,40	2,93
			086068		086075		086082		086099 *	
ZS 12 Cink siva RAL extra			1,50	1,83	1,55	1,89	1,60	1,95	2,40	2,93
			086310		086327 *		086334		086341 *	
PZ 13 Zelena patina RAL extra							4,00	4,88		
							086174			
PM 14 Baker patina RAL extra							4,00	4,88		
							086150			
Aluminij 15 Natur			1,35	1,65	1,40	1,71	1,45	1,77	2,15	2,62
			085818		085825		085832		085849	
Pakiranje v kos	6/60		6/60		6/60		6/60		4/40	
Pakiranje v kos	1 440		1 440		1 440		1 440		960	

* Izdelava po meri



KOTLIČEK

W-WKL



Nominalna velikost	200/60		250/60		250/80		280/80		280/100	
	Brez DDV	Z DDV	Brez DDV	Z DDV	Brez DDV	Z DDV	Brez DDV	Z DDV	Brez DDV	Z DDV
AN 1 Antracit RAL 7016	10,00	12,20	10,60	12,93	11,30	13,79	13,00	15,86	12,50	15,25
	078278		078285		078292		078308		078315	
TM 2 Testa di Moro RAL 8028	10,00	12,20	10,60	12,93	11,30	13,79	13,00	15,86	12,50	15,25
	079152		079169		079176		079183		079190	
SS 3 Siva mišje RAL 7005	10,00	12,20	10,60	12,93	11,30	13,79	13,00	15,86	12,50	15,25
	079046 *		079053 *		079060		079077		079084	
ZH 4 Anodic RAL 7013	10,00	12,20	10,60	12,93	11,30	13,79	13,00	15,86	12,50	15,25
	079268 *		079275		079282		079299		079305	
BH 5 Srebrna RAL 9006	10,00	12,20	10,60	12,93	11,30	13,79	13,00	15,86	12,50	15,25
	078490 *		078506 *		078513		078520		078537	
BHT 6 Temno srebrna RAL 9007					11,30	13,79	13,00	15,86	12,50	15,25
					101594		101600 *		101617 *	
MH 7 Opečno rdeča RAL 8004	10,00	12,20	10,60	12,93	11,30	13,79	13,00	15,86	12,50	15,25
	078711 *		078728 *		078735		078742		078759	
IC 8 Črna intenzivno RAL 9005	10,00	12,20	10,60	12,93	11,30	13,79	13,00	15,86	12,50	15,25
	078605 *		078612 *		078629		078636		078643	
OC 9 Vinsko rdeča RAL 3009	10,00	12,20	10,60	12,93	11,30	13,79	13,00	15,86	12,50	15,25
	078964 *		078933 *		078940		078957		078971	
B 10 Bela RAL 9010	10,00	12,20	10,60	12,93	11,30	13,79	13,00	15,86	12,50	15,25
	078384 *		078391 *		078407		078414		078421	
MZ 11 Zelena mahovo RAL 6005	10,00	12,20	10,60	12,93	11,30	13,79	13,00	15,86	12,50	15,25
	078827 *		078834 *		078841		078858		078865	
ZS 12 Cink siva RAL extra	10,00	12,20	10,60	12,93	11,30	13,79	13,00	15,86	12,50	15,25
	079374 *		079381 *		079398		079404		079411	
PZ 13 Zelena patina RAL extra										
PM 14 Baker patina RAL extra										
Aluminij 15 Natur	9,00	10,98	9,55	11,65	10,20	12,44	11,70	14,27	11,25	13,73
	078162 *		078179 *		078186		078193		078223	
Pakiranje v kos 	20		20		20		20		20	
Pakiranje v kos 	600		600		600		600		600	

* Izdelava po meri



KOTLIČEK

W-WKL

Nominalna velikost	333/80		333/100		333/120	
	Brez DDV	Z DDV	Brez DDV	Z DDV	Brez DDV	Z DDV
AN 1 Antracit RAL 7016	13,40	16,35	13,70	16,71	18,00	21,96
	078322		078339		078346	
TM 2 Testa di Moro RAL 8028	13,40	16,35	13,70	16,71	18,00	21,96
	079206		079213		079220	
SS 3 Siva mišje RAL 7005	13,40	16,35	13,70	16,71	18,00	21,96
	079091 *		079107		079114	
ZH 4 Anodic RAL 7013	13,40	16,35	13,70	16,71	18,00	21,96
	079312 *		079336		079329	
BH 5 Srebrna RAL 9006	13,40	16,35	13,70	16,71	18,00	21,96
	078544		078551		078568	
BHT 6 Temno srebrna RAL 9007	13,40	16,35	13,70	16,71	18,00	21,96
	101624 *		101631		101648 *	
MH 7 Opečno rdeča RAL 8004	13,40	16,35	13,70	16,71	18,00	21,96
	078766 *		078773		078780	
IC 8 Črna intenzivno RAL 9005	13,40	16,35	13,70	16,71	18,00	21,96
	078650 *		078667		078674	
OC 9 Vinsko rdeča RAL 3009	13,40	16,35	13,70	16,71	18,00	21,96
	078988 *		078995		079015	
B 10 Bela RAL 9010	13,40	16,35	13,70	16,71	18,00	21,96
	078438		078445		078452	
MZ 11 Zelena mahovo RAL 6005	13,40	16,35	13,70	16,71	18,00	21,96
	078872 *		078889		078896	
ZS 12 Cink siva RAL extra	13,40	16,35	13,70	16,71	18,00	21,96
	079428 *		079435		079442	
PZ 13 Zelena patina RAL extra			19,20	23,42		
			112675			
PM 14 Baker patina RAL extra			19,20	23,42		
			112668			
Aluminij 15 Natur	12,05	14,70	12,35	15,07	16,20	19,76
	078209		078230		078216	
Pakiranje v kos 	20		20		15	
Pakiranje v kos 	600		600		300	

* Izdelava po meri



KOTLIČEK

W-WKL

Nominalna velikost	400/100		400/120		400/150	
	Brez DDV	Z DDV	Brez DDV	Z DDV	Brez DDV	Z DDV
AN 1 Antracit RAL 7016	18,70	22,81	20,00	24,40	35,00	42,70
	078353 *		078360		078377 *	
TM 2 Testa di Moro RAL 8028	18,70	22,81	20,00	24,40	35,00	42,70
	079237 *		079244		079251 *	
SS 3 Siva mišje RAL 7005	18,70	22,81	20,00	24,40	35,00	42,70
	079121 *		079138		079145 *	
ZH 4 Anodic RAL 7013	18,70	22,81	20,00	24,40	35,00	42,70
	079343 *		079350		079367	
BH 5 Srebrna RAL 9006	18,70	22,81	20,00	24,40	35,00	42,70
	078575 *		078582		078599 *	
BHT 6 Temno srebrna RAL 9007			20,00	24,40		
			080288 *			
MH 7 Opečno rdeča RAL 8004	18,70	22,81	20,00	24,40	35,00	42,70
	078797 *		078803		078810 *	
IC 8 Črna intenzivno RAL 9005	18,70	22,81	20,00	24,40	35,00	42,70
	078681 *		078698		078704 *	
OC 9 Vinsko rdeča RAL 3009	18,70	22,81	20,00	24,40	35,00	42,70
	079008 *		079022 *		079039 *	
B 10 Bela RAL 9010	18,70	22,81	20,00	24,40	35,00	42,70
	078469 *		078476		078483 *	
MZ 11 Zelena mahovo RAL 6005	18,70	22,81	20,00	24,40	35,00	42,70
	078902 *		078919		078926 *	
ZS 12 Cink siva RAL extra	18,70	22,81	20,00	24,40	35,00	42,70
	079459 *		079466		079473 *	
PZ 13 Zelena patina RAL extra						
PM 14 Baker patina RAL extra						
Aluminij 15 Natur	16,85	20,56	18,00	21,96	31,50	38,43
	078247 *		078254		078261 *	
Pakiranje v kos 	15		15		15	
Pakiranje v kos 	300		300		300	

* Izdelava po meri



NOV PRIČVRSTILNI
SISTEM FEDER OMOGOČA
LAHKO OBRAČANJE KOLENA
DO ŽELJENE SMERI IN OSTANE
FIKSIRANO V VSAKI POZICIJI.
ENOSTAVNA MONTAŽA NA
BILO KATERO KOLENO
BREZ KOVIČENJA.



1



2



3





ALUMINIUM POLYESTER + NATUR

INOX LOVILEC NESNAGE

N-NZN



Nominalna velikost	EAN številko izdelka	Pakiranje v kos		Cena [€/kos]	
				Brez DDV	Z DDV
60	001153	30	2 160	5,55	6,77
80	001160	20	1 440	5,60	6,83
100	001177	15	1 080	5,70	6,95
120	001184	10	720	6,20	7,56
150	001191	5	360	9,80	11,96



ZBIRNI KOTLIČEK DESIGN

W-WKLZ DE

Nominalna velikost	80		100		120	
	Brez DDV	Z DDV	Brez DDV	Z DDV	Brez DDV	Z DDV
AN 1 Antracit RAL 7016	99,90	121,88	99,90	121,88	105,00	128,10
	031044 *		031068		031082 *	
TM 2 Testa di Moro RAL 8028	99,90	121,88	99,90	121,88	105,00	128,10
	032249 *		032263		032287 *	
SS 3 Siva mišje RAL 7005	99,90	121,88	99,90	121,88	105,00	128,10
	032096 *		032119		032133 *	
ZH 4 Anodic RAL 7013	99,90	121,88	99,90	121,88	105,00	128,10
	032393 *		032416		032430 *	
BH 5 Srebrna RAL 9006	99,90	121,88	99,90	121,88	105,00	128,10
	031341 *		031365		031389 *	
BHT 6 Temno srebrna RAL 9007						
MH 7 Opečno rdeča RAL 8004	99,90	121,88	99,90	121,88	105,00	128,10
	031648 *		031662 *		031686 *	
IC 8 Črna intenzivno RAL 9005	99,90	121,88	99,90	121,88	105,00	128,10
	031495 *		031518		031532 *	
OC 9 Vinsko rdeča RAL 3009	99,90	121,88	99,90	121,88	105,00	128,10
	031945 *		031969 *		031983 *	
B 10 Bela RAL 9010	99,90	121,88	99,90	121,88	105,00	128,10
	031198 *		031211		031235 *	
MZ 11 Zelena mahovo RAL 6005	99,90	121,88	99,90	121,88	105,00	128,10
	031792 *		031815 *		031839 *	
ZS 12 Cink siva RAL extra	99,90	121,88	99,90	121,88	105,00	128,10
	032546 *		032560 *		032584 *	
PZ 13 Zelena patina RAL extra						
PM 14 Baker patina RAL extra						
Aluminij 15 Natur	89,90	109,68	89,90	109,68	94,50	115,29
	030894 *		030917 *		030931 *	
Pakiranje v kos 	2		2		2	
Pakiranje v kos 	36		36		36	



* Izdelava po meri



ZBIRNI KOTLIČEK DESIGN EKSCENTRIČE

W-WKLZ DX





Nominalna velikost	80		100		120	
	Brez DDV	Z DDV	Brez DDV	Z DDV	Brez DDV	Z DDV
AN 1 Antracit RAL 7016	115,00	140,30	115,00	140,30	125,00	152,50
	031105 *		031136		031167	
TM 2 Testa di Moro RAL 8028	115,00	140,30	115,00	140,30	125,00	152,50
	032300 *		032331 *		032362 *	
SS 3 Siva mišje RAL 7005	115,00	140,30	115,00	140,30	125,00	152,50
	032157		032188		032218 *	
ZH 4 Anodic RAL 7013	115,00	140,30	115,00	140,30	125,00	152,50
	032454 *		032485 *		032515 *	
BH 5 Srebrna RAL 9006	115,00	140,30	115,00	140,30	125,00	152,50
	031402 *		031433 *		031464 *	
BHT 6 Temno srebrna RAL 9007	115,00	140,30	115,00	140,30	125,00	152,50
	101655 *		101679 *		101693 *	
MH 7 Opečno rdeča RAL 8004	115,00	140,30	115,00	140,30	125,00	152,50
	031709 *		031730 *		031761 *	
IC 8 Črna intenzivno RAL 9005	115,00	140,30	115,00	140,30	125,00	152,50
	031556 *		031587 *		031617 *	
OC 9 Vinsko rdeča RAL 3009	115,00	140,30	115,00	140,30	125,00	152,50
	032003 *		032034 *		032065 *	
B 10 Bela RAL 9010	115,00	140,30	115,00	140,30	125,00	152,50
	031259 *		031280 *		031310 *	
MZ 11 Zelena mahovo RAL 6005	115,00	140,30	115,00	140,30	125,00	152,50
	031853 *		031884 *		031914 *	
ZS 12 Cink siva RAL extra	115,00	140,30	115,00	140,30	125,00	152,50
	032607 *		032638 *		032669 *	
PZ 13 Zelena patina RAL extra						
PM 14 Baker patina RAL extra						
Aluminij 15 Natur	103,50	126,27	110,00	134,20	112,50	137,25
	030955 *		030986 *		031013 *	
Pakiranje v kos 	2		2		2	
Pakiranje v kos 	36		36		36	

* Izdelava po meri

ZBIRNI KOTLIČEK KUBICKI

W-WKLZ KU



Nominalna velikost	80		100		120	
	Brez DDV	Z DDV	Brez DDV	Z DDV	Brez DDV	Z DDV
AN 1 Antracit RAL 7016	128,00	156,16	128,00	156,16	145,00	176,90
	031051 *		031075		031099 *	
TM 2 Testa di Moro RAL 8028	128,00	156,16	128,00	156,16	145,00	176,90
	032256 *		032270 *		032294 *	
SS 3 Siva mišje RAL 7005	128,00	156,16	128,00	156,16	145,00	176,90
	032102 *		032126 *		032140 *	
ZH 4 Anodic RAL 7013	128,00	156,16	128,00	156,16	145,00	176,90
	032409 *		032423 *		032447 *	
BH 5 Srebrna RAL 9006	128,00	156,16	128,00	156,16	145,00	176,90
	031358 *		031372 *		031396 *	
BHT 6 Temno srebrna RAL 9007						
MH 7 Opečno rdeča RAL 8004	128,00	156,16	128,00	156,16	145,00	176,90
	031655 *		031679 *		031693 *	
IC 8 Črna intenzivno RAL 9005	128,00	156,16	128,00	156,16	145,00	176,90
	031501 *		031525 *		031549 *	
OC 9 Vinsko rdeča RAL 3009	128,00	156,16	128,00	156,16	145,00	176,90
	031952 *		031976 *		031990 *	
B 10 Bela RAL 9010	128,00	156,16	128,00	156,16	145,00	176,90
	031204 *		031228 *		031242 *	
MZ 11 Zelena mahovo RAL 6005	128,00	156,16	128,00	156,16	145,00	176,90
	031808 *		031822 *		031846 *	
ZS 12 Cink siva RAL extra	128,00	156,16	128,00	156,16	145,00	176,90
	032553 *		032577 *		032591 *	
PZ 13 Zelena patina RAL extra						
PM 14 Baker patina RAL extra						
Aluminij 15 Natur	115,20	140,54	115,20	140,54	130,50	159,21
	030900 *		030924 *		030948 *	
Pakiranje v kos 	2		2		2	
Pakiranje v kos 	36		36		36	

* Izdelava po meri



ZBIRNI KOTLIČEK KUBICKI EKSCENTRIČEN



W-WKLZ KX

Nominalna velikost	80		100		120	
	Brez DDV	Z DDV	Brez DDV	Z DDV	Brez DDV	Z DDV
AN 1 Antracit RAL 7016	135,00	164,70	135,00	164,70	145,00	176,90
	031112 *		031143		031174 *	
TM 2 Testa di Moro RAL 8028	135,00	164,70	135,00	164,70	145,00	176,90
	032317 *		032348 *		032379 *	
SS 3 Siva mišje RAL 7005	135,00	164,70	135,00	164,70	145,00	176,90
	032164 *		032195 *		032225 *	
ZH 4 Anodiz RAL 7013	135,00	164,70	135,00	164,70	145,00	176,90
	032461 *		032492 *		032522 *	
BH 5 Srebrna RAL 9006	135,00	164,70	135,00	164,70	145,00	176,90
	031419 *		031440 *		031471 *	
BHT 6 Temno srebrna RAL 9007	135,00	164,70	135,00	164,70	145,00	176,90
	101662 *		101686 *		101709 *	
MH 7 Opečno rdeča RAL 8004	135,00	164,70	135,00	164,70	145,00	176,90
	031716 *		031747 *		031778 *	
IC 8 Črna intenzivno RAL 9005	135,00	164,70	135,00	164,70	145,00	176,90
	031563 *		031594 *		031624 *	
OC 9 Vinsko rdeča RAL 3009	135,00	164,70	135,00	164,70	145,00	176,90
	032010 *		032041 *		032072 *	
B 10 Bela RAL 9010	135,00	164,70	135,00	164,70	145,00	176,90
	031266 *		031297 *		031327 *	
MZ 11 Zelena mahovo RAL 6005	135,00	164,70	135,00	164,70	145,00	176,90
	031860 *		031891 *		031921 *	
ZS 12 Cink siva RAL extra	135,00	164,70	135,00	164,70	145,00	176,90
	032614 *		032645 *		032676 *	
PZ 13 Zelena patina RAL extra						
PM 14 Baker patina RAL extra						
Aluminij 15 Natur	121,50	148,23	121,50	148,23	130,50	159,21
	030962 *		030993 *		031020 *	
Pakiranje v kos 	2		2		2	
Pakiranje v kos 	36		36		36	

* Izdelava po meri



ZBIRNI KOTLIČEK KUBICKI EKSCENTRIČEN ISPUSTOM W-WKLZ KXV

Nominalna velikost	80		100		120	
	Brez DDV	Z DDV	Brez DDV	Z DDV	Brez DDV	Z DDV
AN 1 Antracit RAL 7016	160,00	195,20	160,00	195,20	170,00	207,40
	031129 *		031150 *		031181 *	
TM 2 Testa di Moro RAL 8028	160,00	195,20	160,00	195,20	170,00	207,40
	032324 *		032355 *		032386 *	
SS 3 Siva mišje RAL 7005	160,00	195,20	160,00	195,20	170,00	207,40
	032171 *		032201 *		032232 *	
ZH 4 Anodic RAL 7013	160,00	195,20	160,00	195,20	170,00	207,40
	032478 *		032508 *		032539 *	
BH 5 Srebrna RAL 9006	160,00	195,20	160,00	195,20	170,00	207,40
	031426 *		031457 *		031488 *	
BHT 6 Temno srebrna RAL 9007						
MH 7 Opečno rdeča RAL 8004	160,00	195,20	160,00	195,20	170,00	207,40
	031723 *		031754 *		031785 *	
IC 8 Črna intenzivno RAL 9005	160,00	195,20	160,00	195,20	170,00	207,40
	031570 *		031600 *		031631 *	
OC 9 Vinsko rdeča RAL 3009	160,00	195,20	160,00	195,20	170,00	207,40
	032027 *		032058 *		032089 *	
B 10 Bela RAL 9010	160,00	195,20	160,00	195,20	170,00	207,40
	031273 *		031303 *		031334 *	
MZ 11 Zelena mahovo RAL 6005	160,00	195,20	160,00	195,20	170,00	207,40
	031877 *		031907 *		031938 *	
ZS 12 Cink siva RAL extra	160,00	195,20	160,00	195,20	170,00	207,40
	032621 *		032652 *		032683 *	
PZ 13 Zelena patina RAL extra						
PM 14 Baker patina RAL extra						
Aluminij 15 Natur	144,00	175,68	144,00	175,68	153,00	186,66
	030979 *		031006 *		031037 *	
Pakiranje v kos 	2		2		2	
Pakiranje v kos 	36		36		36	

* Izdelava po meri



TESNILNA GUMA ZBIRNEGA KOTLIČKA

P-PKLZ T



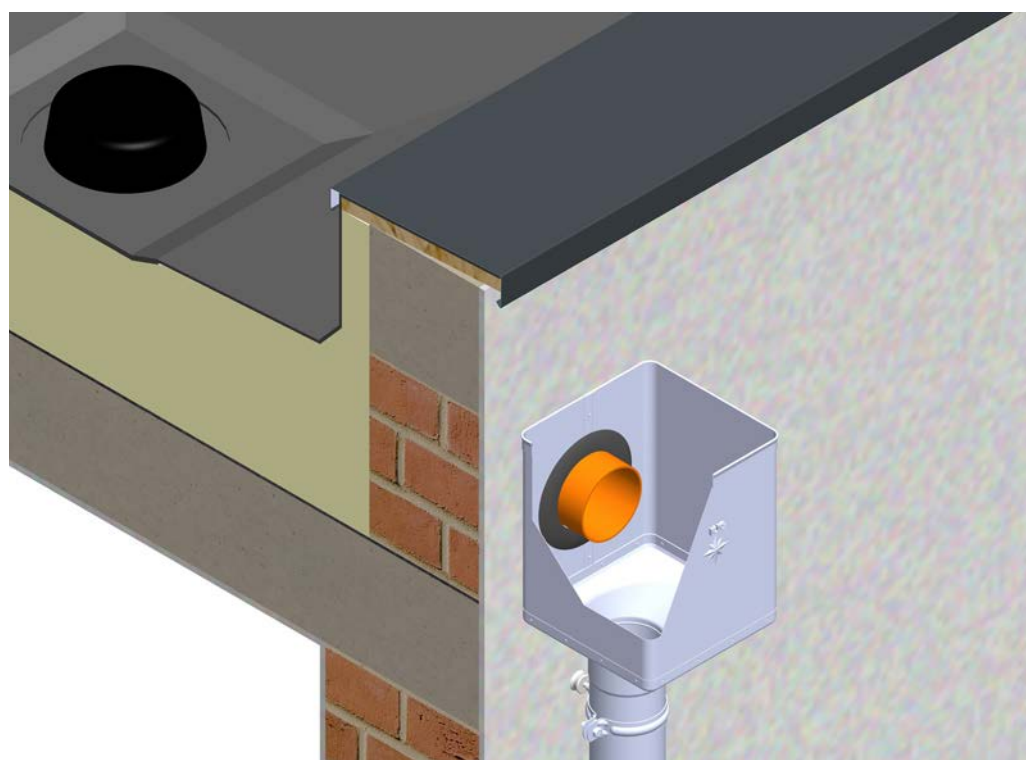

Nominalna velikost	EAN številko izdelka	Pakiranje v kos		Cena [€/kos]	
				Brez DDV	Z DDV
IC 70-85	077103	5	600	4,00	4,88
IC 100-110	077110	5	600	4,10	5,00
IC 110-125	077097	5	600	4,20	5,12
PS 70-85	077134	5	600	4,50	5,49
PS 100-110	077141	5	600	4,90	5,98
PS 110-125	077127	5	600	5,00	6,10



ODTOČNO KOLENO 72°

W-WK

Nominalna velikost	60		80		100		120		150	
	Brez DDV	Z DDV	Brez DDV	Z DDV	Brez DDV	Z DDV	Brez DDV	Z DDV	Brez DDV	Z DDV
AN 1 Antracit RAL 7016	9,20	11,22	9,00	10,98	9,60	11,71	14,60	17,81	32,50	39,65
	074294		074300		074324		074348		074362	
TM 2 Testa di Moro RAL 8028	9,20	11,22	9,00	10,98	9,60	11,71	14,60	17,81	32,50	39,65
	074935		074942		074966		074980		075000 *	
SS 3 Siva mišje RAL 7005	9,20	11,22	9,00	10,98	9,60	11,71	14,60	17,81	32,50	39,65
	074850 *		074867		074881		074904		074928 *	
ZH 4 Anodic RAL 7013	9,20	11,22	9,00	10,98	9,60	11,71	14,60	17,81	32,50	39,65
	075017 *		075024		075048		075062		075086	
BH 5 Srebrna RAL 9006	9,20	11,22	9,00	10,98	9,60	11,71	14,60	17,81	32,50	39,65
	074461		074454		074485		074508		074522 *	
BHT 6 Temno srebrna RAL 9007			9,00	10,98	9,60	11,71	14,60	17,81		
			101587		101563		101549 *			
MH 7 Opečno rdeča RAL 8004	9,20	11,22	9,00	10,98	9,60	11,71	14,60	17,81	32,50	39,65
	074614		074621		074645		074669		074683 *	
IC 8 Črna intenzivno RAL 9005	9,20	11,22	9,00	10,98	9,60	11,71	14,60	17,81	32,50	39,65
	074539 *		074546		074560		074584		074607 *	
OC 9 Vinsko rdeča RAL 3009	9,20	11,22	9,00	10,98	9,60	11,71	14,60	17,81	32,50	39,65
	074775 *		074782		074805		074829		074843 *	
B 10 Bela RAL 9010	9,20	11,22	9,00	10,98	9,60	11,71	14,60	17,81	32,50	39,65
	074379		074386		074409		074423		074447 *	
MZ 11 Zelena mahovo RAL 6005	9,20	11,22	9,00	10,98	9,60	11,71	14,60	17,81	32,50	39,65
	074690 *		074706		074720		074744		074768 *	
ZS 12 Cink siva RAL extra	9,20	11,22	9,00	10,98	9,60	11,71	14,60	17,81	32,50	39,65
	075093 *		075109		075123		075147		075161 *	
PZ 13 Zelena patina RAL extra					9,20	11,22				
					112644					
PM 14 Baker patina RAL extra					9,20	11,22				
					112620					
Aluminij 15 Natur	8,10	9,88	8,10	9,88	8,90	10,86	14,50	17,69	29,00	35,38
	074218		074225		074249		074263		074287 *	
Pakiranje v kos 	25		25		25		15		5	
Pakiranje v kos 	600		400		300		180		60	



* Izdelava po meri



ODTOČNO KOLENO 85°

W-WKR





Nominalna velikost	80		100		120	
	Brez DDV	Z DDV	Brez DDV	Z DDV	Brez DDV	Z DDV
AN 1 Antracit RAL 7016	11,20	13,66	14,00	17,08	18,00	21,96
	074317		074331		074355 *	
TM 2 Testa di Moro RAL 8028	11,20	13,66	14,00	17,08	18,00	21,96
	074959		074973		074997 *	
SS 3 Siva mišje RAL 7005	11,20	13,66	14,00	17,08	18,00	21,96
	074874 *		074898		074911 *	
ZH 4 Anodic RAL 7013	11,20	13,66	14,00	17,08	18,00	21,96
	075031 *		075055		075079 *	
BH 5 Srebrna RAL 9006	11,20	13,66	14,00	17,08	18,00	21,96
	074478 *		074492		074515 *	
BHT 6 Temno srebrna RAL 9007	11,20	13,66	14,00	17,08	18,00	21,96
	101570 *		101556 *		101532 *	
MH 7 Opečno rdeča RAL 8004	11,20	13,66	14,00	17,08	18,00	21,96
	074638 *		074652		074676 *	
IC 8 Črna intenzivno RAL 9005	11,20	13,66	14,00	17,08	18,00	21,96
	074553 *		074577 *		074591 *	
OC 9 Vinsko rdeča RAL 3009	11,20	13,66	14,00	17,08	18,00	21,96
	074799 *		074812 *		074836 *	
B 10 Bela RAL 9010	11,20	13,66	14,00	17,08	18,00	21,96
	074393		074416		074430 *	
MZ 11 Zelena mahovo RAL 6005	11,20	13,66	14,00	17,08	18,00	21,96
	074713 *		074737 *		074751 *	
ZS 12 Cink siva RAL extra	11,20	13,66	14,00	17,08	18,00	21,96
	075116 *		075130 *		075154 *	
PZ 13 Zelena patina RAL extra			9,80	11,96		
				112651		
PM 14 Baker patina RAL extra			9,80	11,96		
				112637		
Aluminij 15 Natur	10,10	12,32	12,60	15,37	16,20	19,76
	074232 *		074256		074270 *	
Pakiranje v kos 	25		25		15	
Pakiranje v kos 	400		300		180	

* Izdelava po meri

ODTOČNO KOLENO 40°

W-WKT

Nominalna velikost	80		100		120	
	Brez DDV	Z DDV	Brez DDV	Z DDV	Brez DDV	Z DDV
AN 1 Antracit RAL 7016	8,90	10,86	11,00	13,42	14,90	18,18
	081414		081421		081438	
TM 2 Testa di Moro RAL 8028	8,90	10,86	11,00	13,42	14,90	18,18
	081650		081667		081674 *	
SS 3 Siva mišje RAL 7005	8,90	10,86	11,00	13,42	14,90	18,18
	081629		081636		081643	
ZH 4 Anodic RAL 7013	8,90	10,86	11,00	13,42	14,90	18,18
	081681		081698		081704	
BH 5 Srebrna RAL 9006	8,90	10,86	11,00	13,42	14,90	18,18
	081476		081483		081490 *	
BHT 6 Temno srebrna RAL 9007	8,90	10,86	11,00	13,42	14,90	18,18
	101778 *		101785 *		101792 *	
MH 7 Opečno rdeča RAL 8004	8,90	10,86	11,00	13,42	14,90	18,18
	081537		081544		081551 *	
IC 8 Črna intenzivno RAL 9005	8,90	10,86	11,00	13,42	14,90	18,18
	081506 *		081513 *		081520 *	
OC 9 Vinsko rdeča RAL 3009	8,90	10,86	11,00	13,42	14,90	18,18
	081599 *		081605		081612 *	
B 10 Bela RAL 9010	8,90	10,86	11,00	13,42	14,90	18,18
	081445		081452		081469	
MZ 11 Zelena mahovo RAL 6005	8,90	10,86	11,00	13,42	14,90	18,18
	081568		081575		081582	
ZS 12 Cink siva RAL extra	8,90	10,86	11,00	13,42	14,90	18,18
	081711		081728		081735	
PZ 13 Zelena patina RAL extra						
PM 14 Baker patina RAL extra						
Aluminij 15 Natur	8,00	9,76	9,90	12,08	13,95	17,02
	081384		081391		081407	
Pakiranje v kos 	25		25		15	
Pakiranje v kos 	400		300		240	

* Izdelava po meri



CEV ODVODNA [s=0,70]

W-WZR



Nominalna velikost	60		80		80		80	
Dolžina v m	2,0		3,0		4,0		6,0	
Cena v €/m	Brez DDV	Z DDV	Brez DDV	Z DDV	Brez DDV	Z DDV	Brez DDV	Z DDV
AN 1 Antracit RAL 7016	7,50	9,15	6,35	7,75	6,35	7,75	6,35	7,75
	050106		050113		050120		050137 *	
TM 2 Testa di Moro RAL 8028	7,50	9,15	6,35	7,75	6,35	7,75	6,35	7,75
	050762		050779		050786		050793 *	
SS 3 Siva mišje RAL 7005	7,50	9,15	6,35	7,75	6,35	7,75	6,35	7,75
	050687		050694		050700		052032 *	
ZH 4 Anodic RAL 7013	7,50	9,15	6,35	7,75	6,35	7,75	6,35	7,75
	050861		050878		051059		050892 *	
BH 5 Srebrna RAL 9006	7,50	9,15	6,35	7,75	6,35	7,75	6,35	7,75
	050281		050298		050304		098283 *	
BHT 6 Temno srebrna RAL 9007			6,35	7,75				
			101952 *					
MH 7 Opečno rdeča RAL 8004	7,50	9,15	6,35	7,75	6,35	7,75		
	050441 *		050458		050465			
IC 8 Črna intenzivno RAL 9005	7,50	9,15	6,35	7,75	6,35	7,75		
	050366 *		050373		050380			
OC 9 Vinsko rdeča RAL 3009	7,50	9,15	6,35	7,75	6,35	7,75		
	050601		050618		050625 *			
B 10 Bela RAL 9010	7,50	9,15	6,35	7,75	6,35	7,75		
	050205		050212		050229			
MZ 11 Zelena mahovo RAL 6005	7,50	9,15	6,35	7,75	6,35	7,75		
	050526		050533		050540			
ZS 12 Cink siva RAL extra	7,50	9,15	6,35	7,75	6,35	7,75		
	050960 *		050977		050984 *			
PZ 13 Zelena patina RAL extra								
PM 14 Baker patina RAL extra								
Aluminij 15 Natur	6,30	7,69	5,65	6,89	5,65	6,89	5,65	6,89
	050021		050038		050045		052070 *	
Pakiranje v m 	10		18		24		30	
Pakiranje v m 	490		216		288		750	

* Izdelava po meri



CEV ODVODNA [s=0,70]

W-WZR

Nominalna velikost	100		100		100	
	3,0		4,0		6,0	
Dolžina v m	3,0		4,0		6,0	
	3,0		4,0		6,0	
Cena v €/m	Brez DDV	Z DDV	Brez DDV	Z DDV	Brez DDV	Z DDV
	AN 1 Antracit RAL 7016	7,05	8,60	7,05	8,60	6,95
050144		050151		050168 *		
TM 2 Testa di Moro RAL 8028	7,05	8,60	7,05	8,60	6,95	8,48
	050809		050816		050823 *	
SS 3 Siva mišje RAL 7005	7,05	8,60	7,05	8,60	6,95	8,48
	050717		050724		052049 *	
ZH 4 Anodic RAL 7013	7,05	8,60	7,05	8,60	6,95	8,48
	050908		050915		050922 *	
BH 5 Srebrna RAL 9006	7,05	8,60	7,05	8,60	6,95	8,48
	050311		050328		052056 *	
BHT 6 Temno srebrna RAL 9007	7,05	8,60	7,05	8,60		
	101969		101976			
MH 7 Opečno rdeča RAL 8004	7,05	8,60	7,05	8,60		
	050472		050489			
IC 8 Črna intenzivno RAL 9005	7,05	8,60	7,05	8,60		
	050397		050403			
OC 9 Vinsko rdeča RAL 3009	7,05	8,60	7,05	8,60		
	050632		050649			
B 10 Bela RAL 9010	7,05	8,60	7,05	8,60		
	050236		050243			
MZ 11 Zelena mahovo RAL 6005	7,05	8,60	7,05	8,60		
	050557		050564			
ZS 12 Cink siva RAL extra	7,05	8,60	7,05	8,60		
	050991		051004			
PZ 13 Zelena patina RAL extra	9,95	12,14	9,95	12,14		
	112828		112835 *			
PM 14 Baker patina RAL extra	9,95	12,14	9,95	12,14		
	112804		112811 *			
Aluminij 15 Natur	6,70	8,17	6,70	8,17	6,55	7,99
	050052		050069		052025 *	
Pakiranje v m 	18		24		30	
Pakiranje v m 	180		240		480	

* Izdelava po meri



CEV ODVODNA [s=0,70]

W-WZR

Nominalna velikost	120		120		120		150	
Dolžina v m	3,0		4,0		6,0		3,0	
Cena v €/m	Brez DDV	Z DDV	Brez DDV	Z DDV	Brez DDV	Z DDV	Brez DDV	Z DDV
AN 1 Antracit RAL 7016	9,50	11,59	9,50	11,59			14,75	18,00
	050175		050182				050199 *	
TM 2 Testa di Moro RAL 8028	9,50	11,59	9,50	11,59	9,50	11,59	14,75	18,00
	050830		050847		052063 *		050854 *	
SS 3 Siva mišje RAL 7005	9,50	11,59	9,50	11,59			14,75	18,00
	050731		050748				050755 *	
ZH 4 Anodic RAL 7013	9,50	11,59	9,50	11,59			14,75	18,00
	050939		050946				050953 *	
BH 5 Srebrna RAL 9006	9,50	11,59	9,50	11,59			14,75	18,00
	050335		050342				050359 *	
BHT 6 Temno srebrna RAL 9007	9,50	11,59						
	101983							
MH 7 Opečno rdeča RAL 8004	9,50	11,59	9,50	11,59			14,75	18,00
	050496		050502				050519 *	
IC 8 Črna intenzivno RAL 9005	9,50	11,59	9,50	11,59			14,75	18,00
	050410		050427				050434 *	
OC 9 Vinsko rdeča RAL 3009	9,50	11,59	9,50	11,59			14,75	18,00
	050656		050663				050670 *	
B 10 Bela RAL 9010	9,50	11,59	9,50	11,59			14,75	18,00
	050250		050267				050274 *	
MZ 11 Zelena mahovo RAL 6005	9,50	11,59	9,50	11,59			14,75	18,00
	050571		050588				050595 *	
ZS 12 Cink siva RAL extra	9,50	11,59	9,50	11,59			14,75	18,00
	051011 *		051028				051035 *	
PZ 13 Zelena patina RAL extra								
PM 14 Baker patina RAL extra								
Aluminij 15 Natur	8,30	10,13	8,30	10,13			13,00	15,86
	050076		050083				050090 *	
Pakiranje v m 	18		24		30		3	
Pakiranje v m 	144		192		-		84	

* Izdelava po meri





ALUMINIUM POLYESTER + NATUR



PVC CEVNA FOLIJA

SD-ZR FOLIA KJG



Nominalna velikost	Dolžina v m	EAN številko izdelka	Pakiranje v m		Cena [€/m]	
					Brez DDV	Z DDV
60-150	100,0	139726	100	6 000	0,38	0,46

ALUMINIUM
POLYESTER + NATUR

KOLENO IZOGIBNO

W-WKO





Nominalna velikost	80		100		120	
	Brez DDV	Z DDV	Brez DDV	Z DDV	Brez DDV	Z DDV
AN 1 Antracit RAL 7016	11,00	13,42	13,50	16,47	16,00	19,52
	063328		008411		011985	
TM 2 Testa di Moro RAL 8028	11,00	13,42	13,50	16,47	16,00	19,52
	023353		023377		023421	
SS 3 Siva mišje RAL 7005	11,00	13,42	13,50	16,47	16,00	19,52
	023230		023285		023919	
ZH 4 Anodic RAL 7013	11,00	13,42	13,50	16,47	16,00	19,52
	023476		023513		023537	
BH 5 Srebna RAL 9006	11,00	13,42	13,50	16,47	16,00	19,52
	064837		057877		057884	
BHT 6 Temno srebna RAL 9007	11,00	13,42	13,50	16,47	16,00	19,52
	101716		101723		101730 *	
MH 7 Opečno rdeča RAL 8004	11,00	13,42	13,50	16,47	16,00	19,52
	000316		000330		048738	
IC 8 Črna intenzivno RAL 9005	11,00	13,42	13,50	16,47	16,00	19,52
	057891		057907		048226 *	
OC 9 Vinsko rdeča RAL 3009	11,00	13,42	13,50	16,47	16,00	19,52
	000507		068712		023209	
B 10 Bela RAL 9010	11,00	13,42	13,50	16,47	16,00	19,52
	012029		013804		013811	
MZ 11 Zelena mahovo RAL 6005	11,00	13,42	13,50	16,47	16,00	19,52
	011923		000453		000477	
ZS 12 Cink siva RAL extra	11,00	13,42	13,50	16,47	16,00	19,52
	023582		023629		023650	
PZ 13 Zelena patina RAL extra			16,90	20,62		
			112699			
PM 14 Baker patina RAL extra			16,90	20,62		
			112682			
Aluminij 15 Natur	9,90	12,08	12,15	14,82	14,40	17,57
	077165		077172		077189	
Pakiranje v kos 	20		20		15	
Pakiranje v kos 	320		240		180	

* Izdelava po meri

REDUKCIJA CEVI 72°

W-WZO

Nominalna velikost	80/80		100/80		100/100	
	Brez DDV	Z DDV	Brez DDV	Z DDV	Brez DDV	Z DDV
AN 1 Antracit RAL 7016	38,50	46,97	39,50	48,19	39,90	48,68
	096630 *		096647 *		096654	
TM 2 Testa di Moro RAL 8028	38,50	46,97	39,50	48,19	39,90	48,68
	110473 *		110480 *		110497	
SS 3 Siva mišje RAL 7005	38,50	46,97	39,50	48,19	39,90	48,68
	110404 *		110411 *		110428 *	
ZH 4 Anodic RAL 7013	38,50	46,97	39,50	48,19	39,90	48,68
	110541 *		110558 *		110565	
BH 5 Srebrna RAL 9006	38,50	46,97	39,50	48,19	39,90	48,68
	110053 *		110060 *		110077 *	
BHT 6 Temno srebrna RAL 9007	38,50	46,97	39,50	48,19	39,90	48,68
	096555 *		096623 *		109972 *	
MH 7 Opečno rdeča RAL 8004	38,50	46,97	39,50	48,19	39,90	48,68
	110190 *		110206 *		110213 *	
IC 8 Črna intenzivno RAL 9005	38,50	46,97	39,50	48,19	39,90	48,68
	110121 *		110138 *		110145 *	
OC 9 Vinsko rdeča RAL 3009	38,50	46,97	39,50	48,19	39,90	48,68
	110336 *		110343 *		110350 *	
B 10 Bela RAL 9010	38,50	46,97	39,50	48,19	39,90	48,68
	109989 *		109996 *		110008 *	
MZ 11 Zelena mahovo RAL 6005	38,50	46,97	39,50	48,19	39,90	48,68
	110268 *		110275 *		110282	
ZS 12 Cink siva RAL extra	38,50	46,97	39,50	48,19	39,90	48,68
	110619 *		110626 *		110633 *	
PZ 13 Zelena patina RAL extra						
PM 14 Baker patina RAL extra						
Aluminij 15 Natur	34,60	42,21	35,50	43,31	35,90	43,80
	096562 *		096579 *		096586 *	
Pakiranje v kos 	4		4		4	
Pakiranje v kos 	90		120		120	



* Izdelava po meri



REDUKCIJA CEVI 72°

W-WZO





Nominalna velikost	120/80		120/100		120/120	
	Brez DDV	Z DDV	Brez DDV	Z DDV	Brez DDV	Z DDV
AN 1 Antracit RAL 7016	43,00	52,46	43,60	53,19	43,90	53,56
	096661 *		096678 *		096685 *	
TM 2 Testa di Moro RAL 8028	43,00	52,46	43,60	53,19	43,90	53,56
	110503 *		110510 *		110527 *	
SS 3 Siva mišje RAL 7005	43,00	52,46	43,60	53,19	43,90	53,56
	110435 *		110442 *		110459 *	
ZH 4 Anodic RAL 7013	43,00	52,46	43,60	53,19	43,90	53,56
	110572 *		110589 *		110596 *	
BH 5 Srebrna RAL 9006	43,00	52,46	43,60	53,19	43,90	53,56
	110084 *		110091 *		110107 *	
BHT 6 Temno srebrna RAL 9007	43,00	52,46	43,60	53,19	43,90	53,56
	110046 *		110114 *		110183 *	
MH 7 Opečno rdeča RAL 8004	43,00	52,46	43,60	53,19	43,90	53,56
	110220 *		110237 *		110244 *	
IC 8 Črna intenzivno RAL 9005	43,00	52,46	43,60	53,19	43,90	53,56
	110152 *		110169 *		110176 *	
OC 9 Vinsko rdeča RAL 3009	43,00	52,46	43,60	53,19	43,90	53,56
	110367 *		110374 *		110381 *	
B 10 Bela RAL 9010	43,00	52,46	43,60	53,19	43,90	53,56
	110015 *		110022 *		110039 *	
MZ 11 Zelena mahovo RAL 6005	43,00	52,46	43,60	53,19	43,90	53,56
	110299 *		110305 *		110312 *	
ZS 12 Cink siva RAL extra	43,00	52,46	43,60	53,19	43,90	53,56
	110640 *		110657 *		110664 *	
PZ 13 Zelena patina RAL extra						
PM 14 Baker patina RAL extra						
Aluminij 15 Natur	38,70	47,21	39,30	47,95	39,50	48,19
	096593 *		096609 *		096616 *	
Pakiranje v kos 	3		3		3	
Pakiranje v kos 	90		90		90	

* Izdelava po meri

OBJEMKA Z NAVOJEM M10

W-WOB

Nominalna velikost	60		80		100		120		150	
	Brez DDV	Z DDV	Brez DDV	Z DDV	Brez DDV	Z DDV	Brez DDV	Z DDV	Brez DDV	Z DDV
AN 1 Antracit RAL 7016	3,55	4,33	3,35	4,09	3,40	4,15	3,90	4,76	5,85	7,14
	054982		054999		055002		055019		055026	
TM 2 Testa di Moro RAL 8028	3,55	4,33	3,35	4,09	3,40	4,15	3,90	4,76	5,85	7,14
	055439		055446		055453		055460		055477 *	
SS 3 Siva mišje RAL 7005	3,55	4,33	3,35	4,09	3,40	4,15	3,90	4,76	5,85	7,14
	055330 *		055347		055354		055361		055378 *	
ZH 4 Anodic RAL 7013	3,55	4,33	3,35	4,09	3,40	4,15	3,90	4,76	5,85	7,14
	055514		055521		055538		055545		055552 *	
BH 5 Srebrna RAL 9006	3,55	4,33	3,35	4,09	3,40	4,15	3,90	4,76	5,85	7,14
	055088		055095		055101		055118		055125 *	
BHT 6 Temno srebrna RAL 9007			3,35	4,09	3,40	4,15	3,90	4,76		
			101808		101815		101822 *			
MH 7 Opečno rdeča RAL 8004	3,55	4,33	3,35	4,09	3,40	4,15	3,90	4,76	5,85	7,14
	055187 *		055194		055200		055217		055224 *	
IC 8 Črna intenzivno RAL 9005	3,55	4,33	3,35	4,09	3,40	4,15	3,90	4,76	5,85	7,14
	055132 *		055149		055156		055163		055170 *	
OC 9 Vinsko rdeča RAL 3009	3,55	4,33	3,35	4,09	3,40	4,15	3,90	4,76	5,85	7,14
	055286 *		055293		055309		055316		055323 *	
B 10 Bela RAL 9010	3,55	4,33	3,35	4,09	3,40	4,15	3,90	4,76	5,85	7,14
	055033		055040		055057		055064		055071 *	
MZ 11 Zelena mahovo RAL 6005	3,55	4,33	3,35	4,09	3,40	4,15	3,90	4,76	5,85	7,14
	055231 *		055248		055255		055262		055279 *	
ZS 12 Cink siva RAL extra	3,55	4,33	3,35	4,09	3,40	4,15	3,90	4,76	5,85	7,14
	055569 *		055576		055583		055590		055606 *	
PZ 13 Zelena patina RAL extra					8,30	10,13				
					112712					
PM 14 Baker patina RAL extra					8,30	10,13				
					112705					
Aluminij 15 Natur	2,80	3,42	2,60	3,17	2,70	3,29	3,00	3,66	4,65	5,67
	054906 *		054913		054920		054937		054944 *	
Pakiranje v kos 	25		25		25		25		20	
Pakiranje v kos 	3 000		3 000		3 000		3 000		2 400	



* Izdelava po meri



INOX VIJAK ZA OBJEMKO M8x30

P-POB-NSK





Nominalna velikost	EAN številko izdelka	Pakiranje v kos		Cena [€/kos]	
				Brez DDV	Z DDV
M8 x 30 *	139658	1	–	0,25	0,31

* Izdelava po meri

VIJAK ZA OBJEMKO TORX M10

P-POB-HT





Nominalna velikost	EAN številko izdelka	Pakiranje v kos		Cena [€/kos]	
				Brez DDV	Z DDV
80	002464	100	40 000	1,00	1,22
140	002471	100	28 000	1,25	1,53
200	002488	100	20 000	1,55	1,89
250	002495	100	16 000	1,70	2,07
300	002501	100	11 200	1,70	2,07

ALUMINIUM
POLYESTER + NATUR

VLOŽEK M10

P-POB-HN DB





Nominalna velikost	EAN številko izdelka	Pakiranje v kos		Cena [€/kos]	
				Brez DDV	Z DDV
120	002426	100	25 000	0,40	0,49

VLOŽEK Z LAMELO M10

P-POB-HN DB





Nominalna velikost	EAN številko izdelka	Pakiranje v kos		Cena [€/kos]	
				Brez DDV	Z DDV
180	002433	100	12 000	0,42	0,51
240	002440	100	12 000	0,50	0,61
280	002457	100	12 000	0,53	0,65

KOMBINIRANI VIJAK TORX M10

P-POB-ZT/SZ





Nominalna velikost	EAN številko izdelka	Pakiranje v kos		Cena [€/kos]	
				Brez DDV	Z DDV
140	002587	50	10 400	0,45	0,55
180	002594	50	10 400	0,55	0,67

VLOŽEK ZA IZOLACIJO M10

P-POB-HN IZOL





Nominalna velikost	EAN številko izdelka	Pakiranje v kos		Cena [€/kos]	
				Brez DDV	Z DDV
M10 x 96	001207	25	2 625	2,70	3,29

IZOLACIJSKI ZATIČ KONICA ZIDAK BREZ TOPLLOTNE IZOLACIJE

P-POB-HN WDVS140 M10





Nominalna velikost	EAN številko izdelka	Pakiranje v kos		Cena [€/kos]	
				Brez DDV	Z DDV
140	144843	1/5	750	4,80	5,86

IZOLACIJSKI ZATIČ KONICA ZIDAK S TOPLLOTNO IZOLACIJO

P-POB-HN WDVS300 M10





Nominalna velikost	EAN številko izdelka	Pakiranje v kos		Cena [€/kos]	
				Brez DDV	Z DDV
300	144850	1/5	500	7,80	9,52

NERJAVNA UNI PLATFORMA ZA PRITRJEVANJE OB M10

P-POB-HN PLAT M10





Nominalna velikost	EAN številko izdelka	Pakiranje v kos		Cena [€/kos]	
				Brez DDV	Z DDV
M10	144836	25/500	5 000	3,35	4,09

NAVOJNA PALICA M10

P-POB-ZT





Nominalna velikost	EAN številko izdelka	Pakiranje v kos		Cena [€/kos]	
				Brez DDV	Z DDV
60	002556	100	20 800	0,20	0,24
100	002563	100	15 600	0,30	0,37
150	002570	50	10 400	0,55	0,67

PRITRDILNA PLOŠČA M10

P-POB-ZT MP



Nominalna velikost	EAN številko izdelka	Pakiranje v kos		Cena [€/kos]	
				Brez DDV	Z DDV
80 x 30	002518	25	5 200	1,15	1,40

ZAŠČITNI POKROV OBJEMKE

P-POB-HT AKG



Nominalna velikost	EAN številko izdelka	Pakiranje v kos		Cena [€/kos]	
				Brez DDV	Z DDV
TM 29 x 13	002280	50	16 800	0,25	0,31
AN 29 x 13	002211	50	16 800	0,25	0,31
IC 29 x 13	002235	50	16 800	0,25	0,31
OC 29 x 13	002266	50	16 800	0,25	0,31
MH 29 x 13	002242	50	16 800	0,25	0,31
B SB 29 x 13	002228	50	16 800	0,25	0,31
PS BH BHT 29 x 13	002273	50	16 800	0,25	0,31
MZ 29 x 13	002259	50	16 800	0,25	0,31
ZH 29 x 13	002297	50	16 800	0,25	0,31

LOVILEC VODE

W-WZV



Nominalna velikost	80	100	120			
Cena v €/kos	Brez DDV		Brez DDV			
AN 1 Antracit RAL 7016	21,00	25,62	22,00	26,84	30,00	36,60
	035073		035080		035097	
TM 2 Testa di Moro RAL 8028	21,00	25,62	22,00	26,84	30,00	36,60
	035103		035110		035127	
ZH 4 Anodic RAL 7013	21,00	25,62	22,00	26,84	30,00	36,60
	035134		035141		035158	
Pakiranje v kos	6		5		3	
Pakiranje v kos	180		150		90	

LOVILEC VODE S SITOM

W-WZVS



Nominalna velikost	80		100		120	
	Brez DDV	Z DDV	Brez DDV	Z DDV	Brez DDV	Z DDV
AN 1 Antracit RAL 7016	25,50	31,11	28,00	34,16	42,00	51,24
	035226		035233		035240	
TM 2 Testa di Moro RAL 8028	25,50	31,11	28,00	34,16	42,00	51,24
	035462		035479		035486	
SS 3 Siva mišje RAL 7005	25,50	31,11	28,00	34,16	42,00	51,24
	035431		035448		035455	
ZH 4 Anodic RAL 7013	25,50	31,11	28,00	34,16	42,00	51,24
	035493		035509		035516	
BH 5 Srebrna RAL 9006	25,50	31,11	28,00	34,16	42,00	51,24
	035288		035295		035301	
BHT 6 Temno srebrna RAL 9007	25,50	31,11	28,00	34,16	42,00	51,24
	102034 *		102041 *		102058 *	
MH 7 Opečno rdeča RAL 8004	25,50	31,11	28,00	34,16	42,00	51,24
	035349		035356		035363	
IC 8 Črna intenzivno RAL 9005	25,50	31,11	28,00	34,16	42,00	51,24
	035318		035325		035332 *	
OC 9 Vinsko rdeča RAL 3009	25,50	31,11	28,00	34,16	42,00	51,24
	035400		035417		035424	
B 10 Bela RAL 9010	25,50	31,11	28,00	34,16	42,00	51,24
	035257		035264		035271	
MZ 11 Zelena mahovo RAL 6005	25,50	31,11	28,00	34,16	42,00	51,24
	035370		035387		035394	
ZS 12 Cink siva RAL extra	25,50	31,11	28,00	34,16	42,00	51,24
	035523		035530		035547	
PZ 13 Zelena patina RAL extra						
PM 14 Baker patina RAL extra						
Aluminij 15 Natur	20,40	24,89	22,40	27,33	33,60	40,99
	035196 *		035202		035219 *	
Pakiranje v kos 	6		5		3	
Pakiranje v kos 	180		150		90	

* Izdelava po meri



LOVILEC VODE S CEVJO

W-WZVHA



Nominalna velikost	80		120	
	Brez DDV	Z DDV	Brez DDV	Z DDV
AN 1 Antracit RAL 7016	65,00	79,30	125,00	152,50
	018854		018878 *	
TM 2 Testa di Moro RAL 8028	65,00	79,30	125,00	152,50
	019097		019110	
SS 3 Siva mišje RAL 7005	65,00	79,30	125,00	152,50
	019066 *		019080 *	
ZH 4 Anodic RAL 7013	65,00	79,30	125,00	152,50
	019127 *		019141 *	
BH 5 Srebrna RAL 9006	65,00	79,30	125,00	152,50
	018915 *		018939 *	
BHT 6 Temno srebrna RAL 9007	65,00	79,30	125,00	152,50
	102003 *		102027 *	
MH 7 Opečno rdeča RAL 8004	65,00	79,30	125,00	152,50
	018977 *		018991 *	
IC 8 Črna intenzivno RAL 9005	65,00	79,30	125,00	152,50
	018946 *		018960	
OC 9 Vinsko rdeča RAL 3009	65,00	79,30	125,00	152,50
	019035 *		019059 *	
B 10 Bela RAL 9010	65,00	79,30	125,00	152,50
	018885 *		018908 *	
MZ 11 Zelena mahovo RAL 6005	65,00	79,30	125,00	152,50
	019004		019028 *	
ZS 12 Cink siva RAL extra	65,00	79,30	125,00	152,50
	019158 *		019172 *	
PZ 13 Zelena patina RAL extra				
PM 14 Baker patina RAL extra				
Aluminij 15 Natur	58,50	71,37	112,50	137,25
	001481		001504	
Pakiranje v kos 		1		1
Pakiranje v kos 		60		60

* Izdelava po meri



LOVILEC VODE S CEVJO IN GUMBOM

W-WZVHAG

Nominalna velikost	100	
Cena v €/kos	Brez DDV	Z DDV
AN 1 Antracit RAL 7016	60,00	73,20
		018861
TM 2 Testa di Moro RAL 8028	60,00	73,20
		019103
SS 3 Siva mišje RAL 7005	60,00	73,20
		019073
ZH 4 Anodic RAL 7013	60,00	73,20
		019134
BH 5 Srebrna RAL 9006	60,00	73,20
		018922
BHT 6 Temno srebrna RAL 9007	60,00	73,20
		102010 *
MH 7 Opečno rdeča RAL 8004	60,00	73,20
		018984 *
IC 8 Črna intenzivno RAL 9005	60,00	73,20
		018953
OC 9 Vinsko rdeča RAL 3009	60,00	73,20
		019042 *
B 10 Bela RAL 9010	60,00	73,20
		018892
MZ 11 Zelena mahovo RAL 6005	60,00	73,20
		019011
ZS 12 Cink siva RAL extra	60,00	73,20
		019165 *
PZ 13 Zelena patina RAL extra		
PM 14 Baker patina RAL extra		
Aluminij 15 Natur	54,00	65,88
		001498
Pakiranje v kos 	1	
Pakiranje v kos 	60	

* Izdelava po meri





POCINKANO ZAŠČITNA CEV Z REVIZIJSKO ODPRTINO W-WOZR

Nominalna velikost	80		100		100	
	1,0		1,0		1,5	
Dolžina v m	1,0		1,0		1,5	
	1,0		1,0		1,5	
Cena v €/kos	Brez DDV	Z DDV	Brez DDV	Z DDV	Brez DDV	Z DDV
	AN 1 Antracit RAL 7016	64,00	78,08	49,00	59,78	97,00
030344 *		030351 *		030368 *		
TM 2 Testa di Moro RAL 8028	64,00	78,08	49,00	59,78	97,00	118,34
	030641 *		030658 *		030665 *	
SS 3 Siva mišje RAL 7005	64,00	78,08	49,00	59,78	97,00	118,34
	030597 *		030603 *		030610 *	
ZH 4 Anodic RAL 7013	64,00	78,08	49,00	59,78	97,00	118,34
	030696 *		030702 *		030719 *	
BH 5 Srebrna RAL 9006	64,00	78,08	49,00	59,78	97,00	118,34
	030795 *		030801 *		030818 *	
BHT 6 Temno srebrna RAL 9007	64,00	78,08	49,00	59,78	97,00	118,34
	102065 *		102072 *		102096 *	
MH 7 Opečno rdeča RAL 8004	64,00	78,08	49,00	59,78	97,00	118,34
	030443 *		030450 *		030467 *	
IC 8 Črna intenzivno RAL 9005	64,00	78,08	49,00	59,78	97,00	118,34
	030849 *		030856 *		030863 *	
OC 9 Vinsko rdeča RAL 3009	64,00	78,08	49,00	59,78	97,00	118,34
	030542 *		030559 *		030566 *	
B 10 Bela RAL 9010	64,00	78,08	49,00	59,78	97,00	118,34
	030399 *		030405 *		030412 *	
MZ 11 Zelena mahovo RAL 6005	64,00	78,08	49,00	59,78	97,00	118,34
	030498 *		030504 *		030511 *	
ZS 12 Cink siva RAL extra	64,00	78,08	49,00	59,78	97,00	118,34
	030740 *		030757 *		030764 *	
PZ 13 Zelena patina RAL extra						
PM 14 Baker patina RAL extra						
Pocinkano Natur	60,00	73,20	45,00	54,90	89,00	108,58
	009708		009715		009722	
Pakiranje v kos 	1		1		1	
Pakiranje v kos 	70		60		60	

* Izdelava po meri



POCINKANO ZAŠČITNA CEV Z REVIZIJSKO ODPRTINO W-WOZR

Nominalna velikost	120		120	
	1,0		1,5	
Dolžina v m	1,0		1,5	
	1,0		1,5	
Cena v €/kos	Brez DDV	Z DDV	Brez DDV	Z DDV
	AN 1 Antracit RAL 7016	115,00	140,30	165,00
		030375 *		030382 *
TM 2 Testa di Moro RAL 8028	115,00	140,30	165,00	201,30
		030672 *		030689 *
SS 3 Siva mišje RAL 7005	115,00	140,30	165,00	201,30
		030627 *		030634 *
ZH 4 Anodic RAL 7013	115,00	140,30	165,00	201,30
		030726 *		030733 *
BH 5 Srebrna RAL 9006	115,00	140,30	165,00	201,30
		030825 *		030832 *
BHT 6 Temno srebrna RAL 9007	115,00	140,30	165,00	201,30
		102102 *		102089 *
MH 7 Opečno rdeča RAL 8004	115,00	140,30	165,00	201,30
		030474 *		030481 *
IC 8 Črna intenzivno RAL 9005	115,00	140,30	165,00	201,30
		030870 *		030887 *
OC 9 Vinsko rdeča RAL 3009	115,00	140,30	165,00	201,30
		030573 *		030580 *
B 10 Bela RAL 9010	115,00	140,30	165,00	201,30
		030429 *		030436 *
MZ 11 Zelena mahovo RAL 6005	115,00	140,30	165,00	201,30
		030528 *		030535 *
ZS 12 Cink siva RAL extra	115,00	140,30	165,00	201,30
		030771 *		030788 *
PZ 13 Zelena patina RAL extra				
PM 14 Baker patina RAL extra				
Pocinkano Natur	105,00	128,10	143,00	174,46
		009739		009746
Pakiranje v kos 		1		1
Pakiranje v kos 		40		40



* Izdelava po meri



POCINKANO OBJEMKA Z GUMO M10

P-POB-OZR



Nominalna velikost	EAN številko izdelka	Pakiranje v kos		Cena [€/kos]	
				Brez DDV	Z DDV
80	002525	25	1 250	1,55	1,89
100	002532	25	1 250	2,00	2,44
120	002549	20	1 000	2,25	2,75

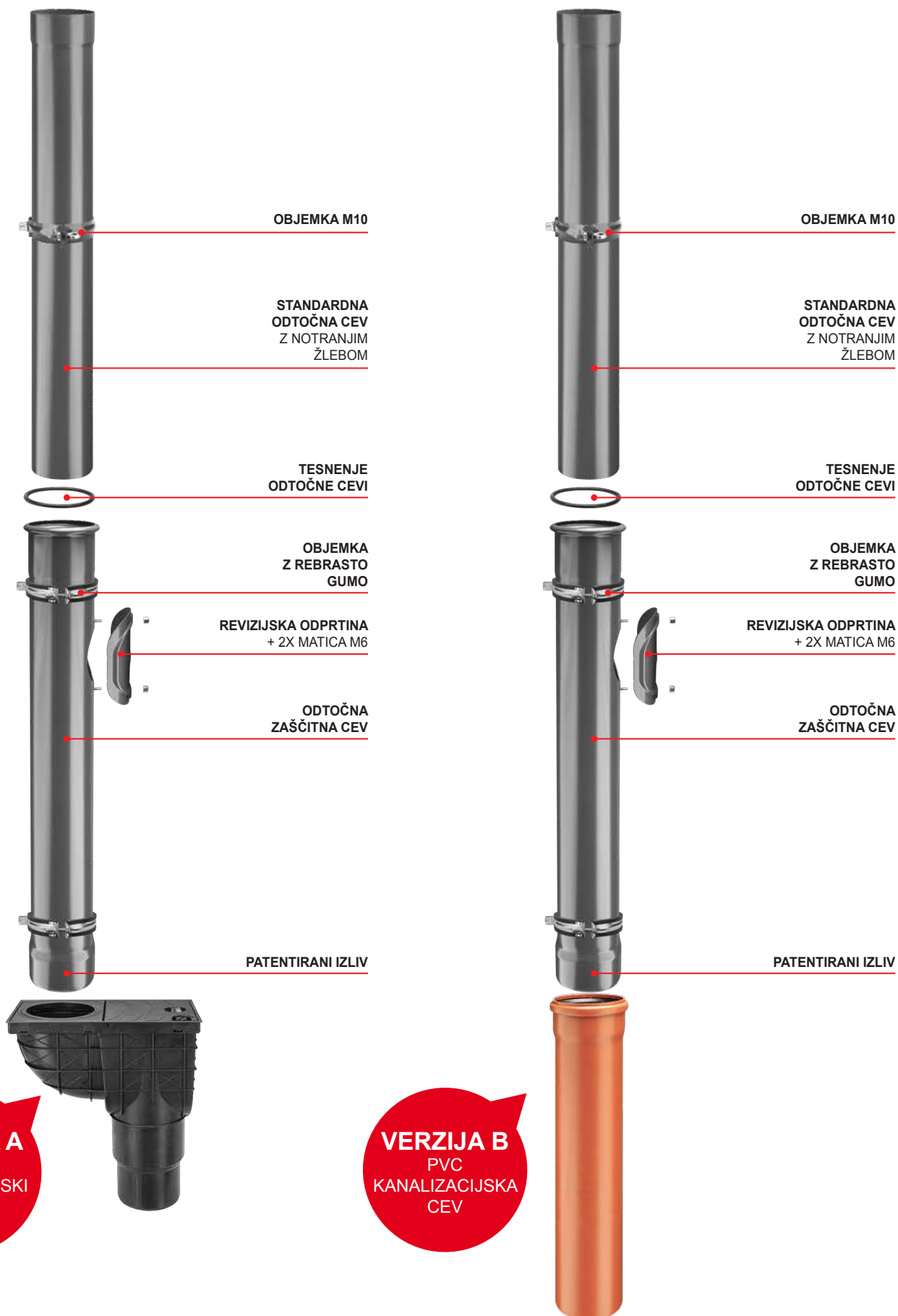

VERZIJA A
PVC
KANALIZACIJSKI
ODTOK

VERZIJA B
PVC
KANALIZACIJSKA
CEV

I. OSNOVNA DOLOČILA

- Družba KJG a.s., s sedežem Malinovského 800/131, 916 21 Čachtice, MŠ: 31 439 951 (v nadaljevanju „prodajalec“), izdaja naslednje splošne poslovne pogoje za prodajo in dobavo žlebnega strešnega sistema in opreme, lahke strešne kritine, trapezov, metalurškega materiala, strešnih dodatkov, orodij, strojev in drugega blaga v povezavi s strešnim sistemom (v nadaljevanju „blago“), ki jo prodajalec izvaja na podlagi okvirne kupne pogodbe (v nadaljevanju „OKP“) v odnosu do podjetnika pri izvajanju njegove poslovne dejavnosti in do države, državne ustanove, upravne enote ali javne institucije za zagotavljanje javnih potreb ali lastnega obratovanja (v nadaljevanju „kupec“).
- Splošni poslovni pogoji so kot del OKP sestavni del vsake posamezne kupoprodajne pogodbe (v nadaljevanju tudi „pogodba“), ki jo sklene prodajalec in kupec na podlagi OKP.

II. SKLENITEV KUPNE POGODBE

- Pisno naročilo kupca pomeni predlog za sklenitev posamezne kupoprodajne pogodbe, pri čemer mora vsako naročilo kupca vsebovati:
 - identifikacijske podatke kupca, ki so potrebni za izdajo računa;
 - opredelitev naročenega blaga (zlasti tip, vrsto, količino in mere);
 - kraj dobave, dobavni rok in način dobave blaga;
 - datum naročila;
 - ime, priimek, funkcija in podpis osebe, ki lahko zastopa kupca.
- Posamezna kupoprodajna pogodba je sklenjena v trenutku, ko prodajalec pisno potrdi naročilo kupca.

III. KUPNINA IN PLAČILNI POGOJI

- Kupec se zavezuje, da bo prodajalcu redno in pravočasno plačal kupnino za naročeno blago. Kupnina je določena po ceniku prodajalca (cena blaga so brez DDV), ki je veljaven na dan naročila kupca. Kupnino bo prodajalec v potrdilu naročila navedel po veljavnih pravnih predpisih vključno z DDV (pri dobavi blaga v Slovenski republiki). V nujnih primerih, kadar se kupnina določi kot samostojna cenovna kalkulacija na podlagi veljavnega cenika, kupec plača kupnino po cenovni kalkulaciji, ki jo prodajalec določi kot končni znesek kupnine glede na stroške, a ne sme biti višja od kupnine, ki je bila določena s kalkulacijo. Kupec ima pravico do popusta na ceno blaga v skladu z OKP. Če prodajalec spremeni v času trajanja OKP višino popusta za kupca pri ceni blaga, nemudoma kupca o tem dejstvu obvesti. Pri dobavi blaga v Slovenski republiki zaračuna prodajalec kupcu tudi DDV po veljavnih pravnih predpisih.
- Kupec ima za naročila blaga določen finančni kreditni limit in zapadlost računov v smislu OKP, prodajalec pa lahko fakturira kupnino kupcu z dnem dobave oziroma odpreme blaga. Po porabi kredita v smislu OKP ali v primeru neplačanega računa s strani kupca v roku zapadlosti, prodajalec lahko prekine dobavo blaga kupcu na podlagi pogodbe in ne potrdi drugega pisnega naročila kupca. S prekinjenimi dobavami blaga prodajalec nadaljuje:
 - v primeru prekoračitve kreditnega limita: s plačilom najstarejših računov do zneska preseženega kreditnega limita in plačilu vrednosti zahtevane odpreme blaga;
 - v primeru neplačanega zapadlega računa: po plačilu računa v celotni višini. Prodajalec lahko kadarkoli v času veljavnosti OKP spremeni kreditni limit kupca.
- Plačilo šteje za pravočasno v primeru priliva na račun prodajalca ali gotovinskega plačila v blagajni prodajalca do roka zapadlosti.
- Če kupec ne plača računa v roku zapadlosti, prodajalec lahko obračuna zamudne obresti v višini 0,05 % neplačanega zneska za vsak dan zamude.

IV. DOBAVA BLAGA IN PRIDRŽEK LASTNINE

- Prodajalec mora dobaviti blago kupcu v pogodbeno dogovorjeni količini, kakovosti in izvedbi, ki je primerna za namembno uporabo blaga. Dobavljeno blago prodajalca mora kupec prevzeti.
- Če se pogodbeni stranki nista dogovorili drugače, prodajalec mora blago zapakirati ali opremiti za prevoz na način, ki je običajen za zadevno blago v poslovnem stiku.
- Dobava blaga se izvede v roku in na način, ki sta ga pogodbeni strani dogovorili s pogodbo.
- Pri dobavi blaga prodajalcu mora zaposleni pri kupcu izkazati pravico do prevzema blaga.
- Če se blago izroča na sedežu prodajalca (oziroma v pripadajočem skladišču prodajalca, ki mu kupec predloži naročilnico) brez nakladanja na prevozno sredstvo, mora prevoznik, ki ga določi kupec, izkazati pravico do prevzema blaga.
- Če se blago dobavi kupcu na kraj dobave, ki je naveden v naročilu, z vozilom prodajalca, zaračuna prodajalec kupcu stroške prevoza po ceniku prevoza, ki je veljaven na dan predložitve naročila s strani kupca. Prodajalec si pridržuje pravico do razkladanja blaga samo v dostopnem terenu po njegovi presoji.
- Če ni določeno drugače, zaračuna prodajalec poštno stroške za pošiljanje blaga kupcu.
- Kupec se zavezuje, da bo v dobavnem roku blago prevzel. Če kupec obveznosti glede prevzema blaga v dobavnem roku ne izpolni, prodajalec ga pozove za izpolnitev obveznosti v dodatnem primernem roku. Če kupec blaga ne prevzame niti v dodatnem primernem roku, prodajalec lahko od pogodbe odstopi.
- Kupec, ki do dneva dobave blaga ne plača celotne kupnine, pridobi pravico do dobavljenega blaga šele s plačilom celotnega zneska kupnine.

V. PREHOD NEVARNOSTI ZA NASTANEK ŠKODE

- Nevarnost nastanka škode na blagu preide na kupca v trenutku prevzema blaga od prodajalca oziroma njegovega prevoznika; če kupec blaga ne prevzame pravočasno, preide nevarnost za nastanek škode na kupca v trenutku, ko prodajalec ali njegov prevoznik omogoči razpolaganje z blagom in kupec blaga ni prevzel ter je kršil pogodbo, čeprav je za možnost prevzema blaga vedel.
- Če prodajalec izroči blago za prevoz prevozniku, ki ga je določil kupec, na svojem sedežu v kraju Čachtice (oziroma v pripadajočem skladišču prodajalca), od katerega bo kupec blago prevzel, preide nevarnost za nastanek škode na kupca v trenutku izročitve blaga prevozniku.
- Če mora prodajalec odposlati blago kupcu, preide nevarnost za nastanek škode na blagu na kupca v trenutku izročitve blaga prvemu prevozniku za prevoz do namembnega kraja.
- Kupec mora pregledati blago takoj po prehodu nevarnosti za nastanek škode na blagu. Če se blago pošilja kupcu, mora blago pregledati takoj po dobavi v namembni kraj.

VI. ODGOVORNOST ZA NAPAKE IN GARANCIJA

- Prodajalec je odgovoren za napake blaga v trenutku prehoda nevarnosti za nastanek škode na kupca, četudi postane napaka očitna šele kasneje. Prodajalec je odgovoren tudi za vsako napako, ki nastane po prehodu nevarnosti nastanka škode na kupca, če škoda nastane zaradi kršitve njegovih obveznosti.
- Če kupec ne pregleda ali ne zagotovi pregleda blaga v času prehoda nevarnosti za nastanek škode na blagu, lahko uveljavi pravice za napake, ki bi jih lahko ugotovil ob takšnem pregledu, če izkaže obstoj takšne napake na blagu že v času prehoda nevarnosti za nastanek škode na blagu.
- Kupec mora prodajalcu sporočiti napake blaga takoj, ko
 - a/ bo ugotovil napako;
 - b/ bi moral ob strokovni skrbi napako ugotoviti ob pregledu, ki ga mora opraviti ob prehodu nevarnosti za nastanek škode ali
 - c/ bo napako ugotovil pozneje, najpozneje pa v dveh letih od časa dobave blaga oziroma dostave blaga na namembni kraj, ki je določen v pogodbi. Pri napakah, na katere se nanaša garancija za kakovost, velja namesto tega roka garancijski rok.
- Če prodajalec nudi kupcu garancijo za kakovost blaga, navede takšno izjavo v samostojnem garancijskem listu, v katerem navede tudi reklamacijski postopek.
- Garancijski rok prične teči z dnem dobave blaga. Če blago odpošilja prodajalec, garancijski rok teče od dneva dostave blaga na namembni kraj. Garancijski rok ne teče v času, kadar kupec ne more blaga uporabljati zaradi napak, za katere je odgovoren prodajalec.
- V primeru dobave blaga z napako kupcu je izključena uporaba določil 436. in 437. člena, drugega, tretjega in četrtega odstavka 439. člena in 441. člena Trgovskega zakonika, prodajalec v takšnem primeru nudi kupcu popust ali odstrani napake, ki jih kupec navaja:
 - a/ z dobavo manjkajočega blaga;
 - b/ s popravilom blaga ali dobavo nadomestnega blaga v primeru odstranljivih napakah ali
 - c/ dobavo nadomestnega blaga v primeru napak, ki jih ni mogoče odstraniti.
- Popust mora ustrezati razliki med vrednostjo, ki bi jo imelo blago brez napak, in vrednostjo, ki jo ima dobavljeno blago z napako, pri čemer je za določitev vrednosti odločilen čas, ko bi morala biti izvedena redna dobava. Kupec, ki mu prodajalec nudi popust pri kupnini, ne more zahtevati nadomestila izgubljenega dohodka zaradi pomanjkljivih karakteristik blaga, na katerega se popust nanaša.
- Pri dobavi nadomestnega blaga lahko prodajalec zahteva, da mu kupec na njegove stroške vrne blago, ki je predmet zamenjave, in sicer v stanju, v kakršnem je bilo dobavljeno. To ne velja, če nezmožnost vračila blaga v tako navedenem stanju ni nastala z ravnanjem ali opustitvijo dolžnega ravnanja kupca, ali je sprememba stanja nastala zaradi rednega pregleda za namen ugotovitve napak blaga. Če pred odkritjem napak kupec blago ali del blaga proda ali blago v celoti ali delno porabi ali spremeni ob njegovi običajni uporabi, mora neprodano ali neuporabljeno ali spremenjeno blago vrniti in zagotoviti prodajalcu nadomestilo do višine, v kateri je imel iz navedene uporabe blaga korist.
- Odgovornost prodajalca za napake, na katere se ne nanaša garancija za kakovost, ne nastane, če so te napake nastale po prehodu nevarnosti za nastanek škode na blagu z zunanjimi dogodki in jih ni povzročil prodajalec ali osebe, s pomočjo katerih je izpolnjeval svojo obveznost.

VII. VIŠJA SILA

- Če po sklenitvi pogodbe nastanejo nepredvidene in nespremenljive okoliščine, ki pomenijo trajno ali začasno oviro za izpolnjevanje obveznosti pogodbenih strani iz sklenjene pogodbe (vis maior), neizpolnitev obveznosti (ob trajni oviri) pogodbenih strani oziroma pozna izpolnitev obveznosti (ob začasni oviri) ne pomeni kršitve te pogodbe, pogodbeni stranki pa ni odgovorna za morebitno škodo, ki bi lahko nastala v povezavi z neizpolnitvijo pogodbenih obveznosti. Če je ovira za izpolnjevanje obveznosti iz pogodbe samo začasna, pogodbeni stranki se zavezuje, da bosta pristopili k izpolnjevanju svojih obveznosti nemudoma po odpravi takšne ovire. Vsaka pogodbeni stranki mora nemudoma obvestiti drugo pogodbeno stran o nastanku zgoraj navedenih ovir.
- Kot vis maior štejejo zlasti naravne nesreče, samovoljno ravnanje tretjih oseb, stavke, delovne izločitve, blokade, vojne (napovedane in nenapovedane), spremenjena politična situacija, ki izključuje ali nesorazmerno otežuje izvajanje pravic in obveznosti iz pogodbe ali drugi podobni dogodki.

VIII. VARSTVO OSEBNIH PODATKOV

- Kupec (za namene tega člena tudi druga oseba, ki je podpisana v OKP in naročilu v imenu kupca) daje prodajalcu izrecno soglasje v smislu zakona št. 428/2002 Ur. l. o varstvu osebnih podatkov po veljavnem besedilu (v nadaljevanju samo »zakon«) z obdelavo osebnih podatkov, ki so navedeni v OKP in naročilu kupca.
 - 8.2. Kupec daje prodajalcu izrecno soglasje z obdelavo osebnih podatkov za namen:
 - a/ izvajanja pravic in obveznosti iz OKP in posamezne pogodbe;
 - b/ vodenja evidence, ki jo mora prodajalec voditi v skladu z zakonom ali na podlagi zakona;
 - c/ trženja.
 - 8.3. Kupec izrecno soglašajo, da prodajalec lahko za namene iz alineje 8.2. posreduje njegove osebne podatke tretji osebi, ki jo je pooblastil za izvajanje zadevne dejavnosti.
 - 8.4. Kupec soglašajo, da prodajalec obdeluje njegove osebne podatke:
 - a/ za čas, ko mora prodajalec voditi evidenco iz alineje 8.2. točka b);
 - b/ za nujno potreben čas za zaščito zakonskih pravic in pravno zagotovljenih interesov prodajalca.
 - 8.5. Kupec jemlje na znanje, da lahko svoje soglasje z obdelavo osebnih podatkov prekliche in zahteva uničenje svojih osebnih podatkov v primeru, da prodajalec oziroma tretje osebe, ki jim je prodajalec posredoval osebne podatke, kršijo zakonske obveznosti.

IX. KONČNA DOLOČILA

- Kupec ne more na tretjo osebo prenesti ali tretji osebi odstopiti pravic iz OKP ali posamezne pogodbe brez izrecnega soglasja prodajalca.
- Če ni s splošnimi poslovnimi pogoji določeno drugače, OKP se lahko spremeni samo s pisnimi aneksi, ki jih podpisajo predstavniki obeh pogodbenih strani.
- Drugečni dogovori iz posamezne pogodbe med prodajalcem in kupcem imajo prednost pred določili OKP in temi splošnimi poslovnimi pogoji. Pravna razmerja, ki niso urejena z OKP, posamezno pogodbo in splošnimi poslovnimi pogoji, se ravnajo po Trgovinskem zakoniku in drugih splošno zavezujočih pravnih predpisih Slovenske republike, pri čemer so izključena kolizijska pravila in uporaba Konvencije Združenih narodov o pogodbah o mednarodni prodaji blaga (CISG) z dne 11.04.1980 in njihovih morebitnih dodatkov v primeru, da ima kupec sedež (kraj poslovanja) v drugi državi ali se blago dobavlja v drugo državo.
- Vse spore, ki nastanejo na podlagi OKP, bodo pogodbeni strani reševale po mirni poti. Reševanje sporov, ki jih ne bo mogoče rešiti sporazumno, je v pristojnosti (izključno) pristojnega sodišča Slovenske republike.
- Te splošne pogoje izdaja prodajalec po 273. členu Trgovskega zakonika, in sicer z veljavnostjo od 01.01.2017