



ODVODNI SISTEM POLUOKRUGLI



**CJENIK
2024**



POWERFUL PARTNER FOR YOUR ROOF



Inox materijal | 3

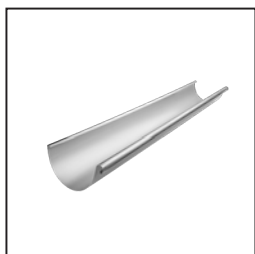

Žlijeb | 6

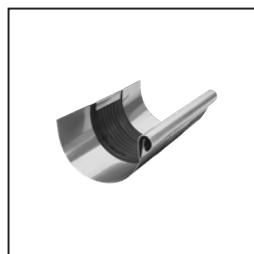

Dilekacija žlijeba | 6



Žlijeb oprema | 8



Kuka | 9



Kutnik | 10



Čelo žlijeba | 10



Kotlić | 11



Koljeno | 13



Odvodna cijev | 14

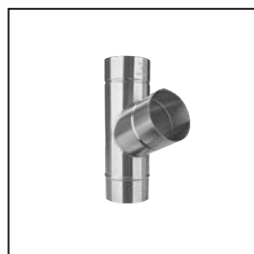

Odvodna cijev oprema | 14



Obujmica | 14

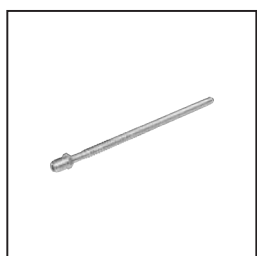

Obujmica oprema | 15



Zadržać vode | 18



Zaštitna cijev | 19

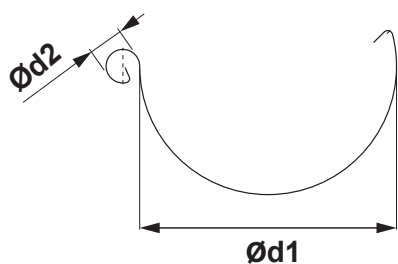

DIMENZIJE KROVNIH ŽLJEBOVA

(dimenzije i mjerne tolerancije po EN 612)

Razvijena širina (mm)	250	280	333
Ød1	105	127	153
Ød2	18	18	20

ZAVARENI TIG

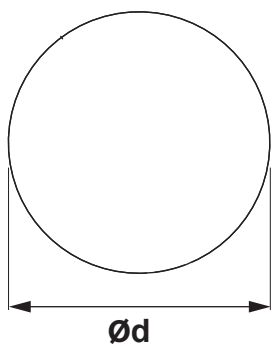

DIMENZIJE KROVNIH CIJEVI

(dimenzije i mjerne tolerancije po EN 612)

Nominalna veličina	60	80	100	120
Nazivna veličina Ød (mm)	60	80	100	120

DIMENZIJE KROVNIH KUKA

(dimenzije i mjerne tolerancije po EN 612)

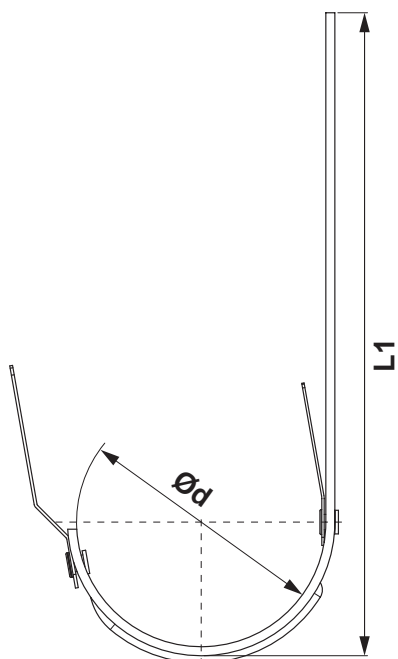

Dimenzije (mm)	L1	Ød
250	310	105
280	345	127
333 – 550	385	153

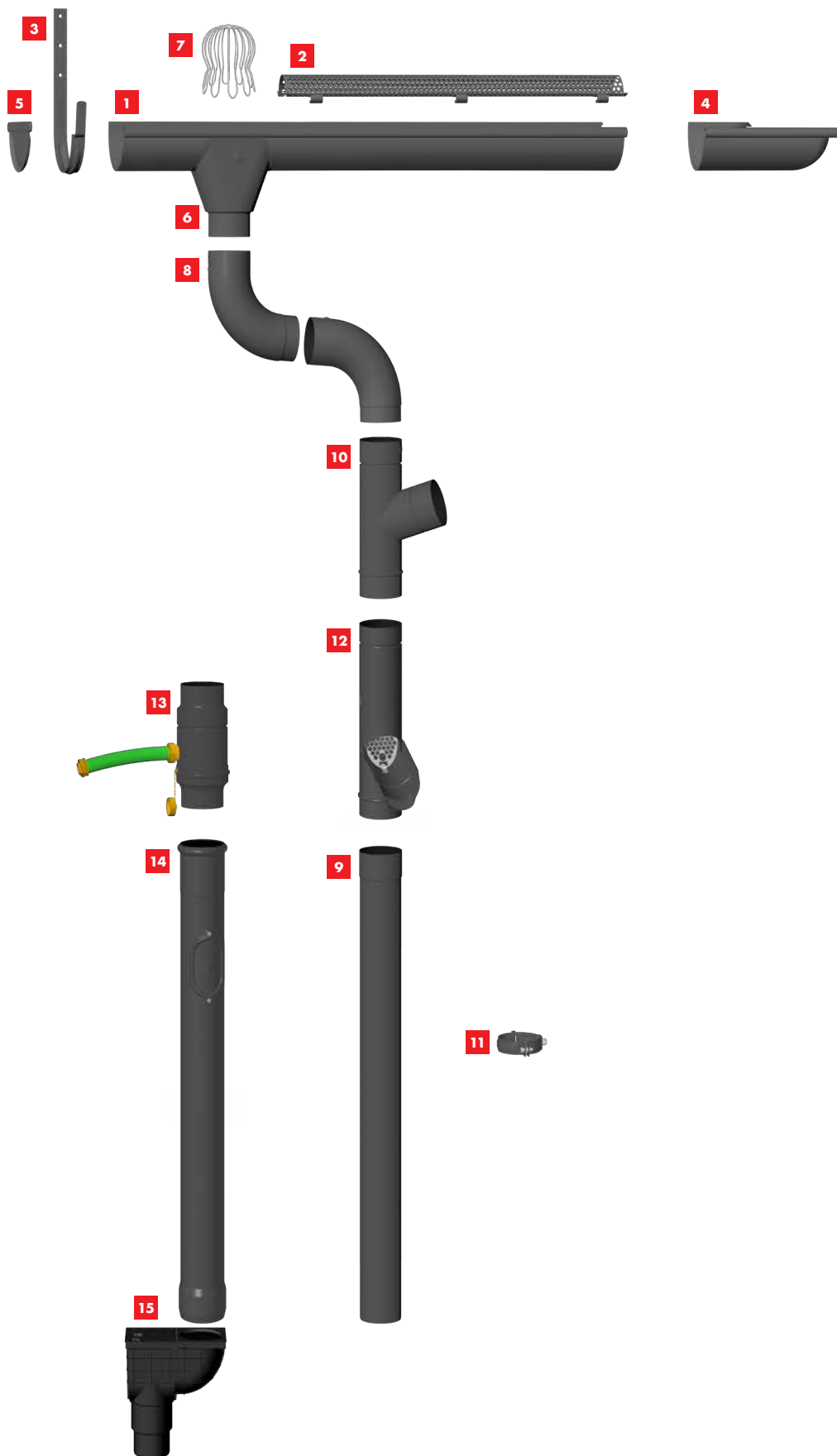



- 1** Žlijeb poluokrugi
- 2** Mrežica za zaštitu od smeća
- 3** Kuka
- 4** Kutnik vanjski
- 5** Čelo žlijeba
- 6** Ispusni kotlić
- 7** Zadržlač smeća
- 8** Koljeno
- 9** Odvodna cijev
- 10** Redukcija cijevi
- 11** Obujmica s navojem M10
- 12** Zadržlač vode sa sitom
- 13** Zadržlač vode sa crijevom
- 14** Zaštitna cijev sa rev.
- 15** Kanalizacijski isp. ravni

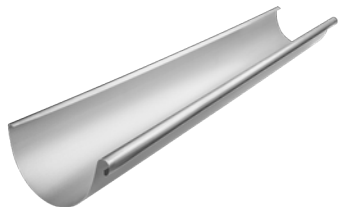

ŽLIJEB POLUOKRUGLI [s=0,50 mm]

N-NZ





Nominalna veličina	Dužina u m	EAN broj narudžbe	Pakiranje u m		Cijena [€/m]	
					Bez PDV	S PDV
250	4,0	086679	20	960	8,75	10,94
280	4,0	086686	20	840	9,80	12,25
333	4,0	086693	20	660	9,95	12,44
333	6,0	086709	30	990	9,95	12,44

ŽLIJEB NATKROVNI [s=0,50 mm]

N-NZS





Nominalna veličina	Dužina u m	EAN broj narudžbe	Pakiranje u m		Cijena [€/m]	
					Bez PDV	S PDV
650 *	4,0	102850	4	200	27,00	33,75

* Proizvodnja po narudžbi

DILETACIJA ŽLIJEBA

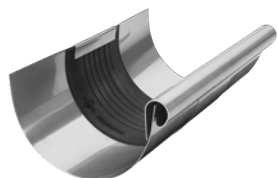
N-NZDI





Nominalna veličina	EAN broj narudžbe	Pakiranje u kom		Cijena [€/kom]	
				Bez PDV	S PDV
250/260	092205	3	360	14,45	18,06
285/260	092212	3	360	15,50	19,38
333/260	092229	5	200	17,10	21,38

DILETACIJA ZA LEŽEĆI ŽLIJEB

N-NZSDI





Nominalna veličina	EAN broj narudžbe	Pakiranje u kom		Cijena [€/kom]	
				Bez PDV	S PDV
670/260	110671	1	40	39,90	49,88

DILETACIJSKA TRAKA

N-NZDIP



Nominalna veličina	Dužina u m	EAN broj narudžbe	Pakiranje u m		Cijena [€/m]	
					Bez PDV	S PDV
260	3,0	102805	3	120	47,50	59,38

KORIŠTENJE SPOJKE ŽLIJEBA I SPOJNE TRAKE

SPOJKA ŽLIJEBA

Primjer montaže: Podkrovni žlijeb razvijene širine do 500 mm. Spojka žlijeba mora biti montirana u međusobnoj udaljenosti 15 m. Za vanjski kutnik i početak žlijeba važi polovica standardne vrijednosti: maksimalno 7,5 m. Za unutarnji kutnik važi četvrtina standardne vrijednosti: maksimalno 3,75 m. Za ostale materijale i dimenzije: vidi tabelica dolje. Kutnici se uvijek smatraju čvrstim točkama.

KROVNI POLUOKRUGLI ŽLJEBOVI

Razvijena širina žlijeba	Aluminij	Pocink, Cinkotit, Bakar, Inox
< 500	12	15
> 500	8	10

SPAJANJE TRAKOM

Unutarnja instalacija: za četvrtaste žlebove pričvršćene za podlogu bez lijepljenja, za krovove s nestandardnim profilom, i oplatu zida limom

KROVNO SPAJANJE TRAKOM

Razvijena širina žlijeba	Aluminij	Pocink, Cinkotit, Bakar, Inox
< 500	8	10
> 500	6	8

Za vanjski kutnik ili početak žlijeba važi polovica standardne vrijednosti. Za unutarnji kutnik važi četvrtina standardne vrijednosti.

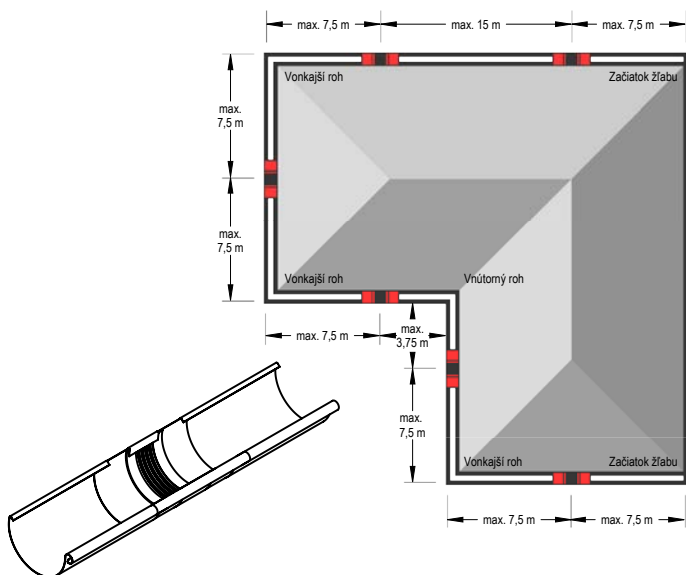

Napomena uz montažu spojne trake.

Za vrijeme montaže uz pomoć mekog lemljenja prvo pokrite dio mokrom krpom (kako ne bi došlo do prelaska topline u središnji gumeni dio). Mora se održavati minimalna udaljenost 6 cm od središnjeg gumenog dijela. U svakom slučaju treba izbjegavati kontakt gume s plamenom.

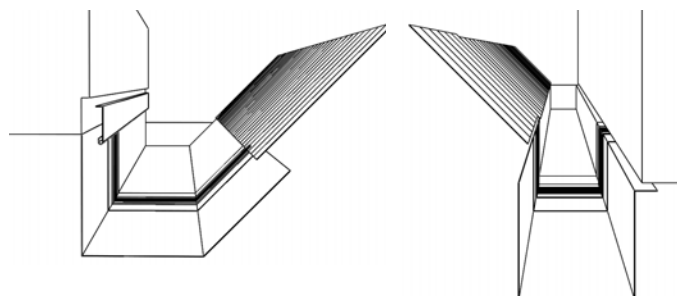

Napomena uz montažu spojne trake.

Kada se savija i montira spojna traka, provjerite sljedeće:

- Klješta za savijanje imaju radijus minimalno 2 mm.
- Za debljinu lima 1 mm se mora održati polumjer savijanja minimalno 5 mm.
- Klješta za savijanje moraju za vrijeme savijanja biti podešena za debljinu 3 do 4 mm, kako bi se spriječio efekt sječenja – oštećenja gume.
- Središnji gumeni dio za vrijeme savijanja ne smije biti pritisnut ili oštećen. Treba zbog toga koristiti aluminijsku limenu traku debljine 2 do 5 mm, i saviti je tako, da se može pričvrstiti kao zaštita za klješta za savijanje. Time ćemo dobiti veći polumjer savijanja, i spriječiti da se ošteti središnji gumeni dio.



ALUMINIJSKA MREŽICA ZA ZAŠTITU OD SMEĆA

W-WZNLM

Nominalna veličina	Džka v m	EAN broj narudžbe	Pakiranje u kom		Cijena [€/kom]	
					Bez PDV	S PDV
333	2,0	064905	25	300	25,50	31,88

PVC ŽLIJEBNI ZADRŽAČ SMEĆA

SD-ZNL MREZKA

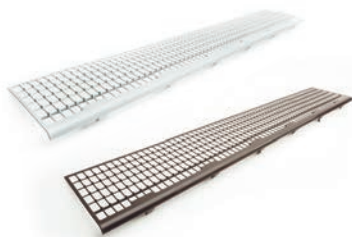

Nominalna veličina	Dužina u m	EAN broj narudžbe	Pakiranje u kom		Cijena [€/kom]	
					Bez PDV	S PDV
171	1,0	008473	30	450	4,50	5,63
171	1,0	008466	30	450	4,50	5,63

PVC ŽLIJEBNI ZADRŽAČ SMEĆA

SD-ZNL N

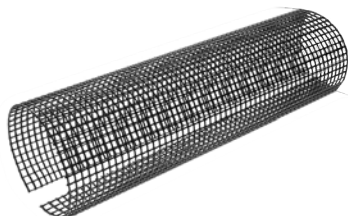

Nominalna veličina	Dužina u m	EAN broj narudžbe	Pakiranje u kom		Cijena [€/kom]	
					Bez PDV	S PDV
250	3,0	008480	10	400	23,90	29,88
280-333	3,0	008497	10	400	24,00	30,00



KUKA

N-NHP



Nominalna veličina	Materijal	EAN broj narudžbe	Pakiranje u kom		Cijena [€/kom]	
					Bez PDV	S PDV
250/430	25/4	092274	10	1 000	4,30	5,38
280/480	25/4	092281	10	1 000	5,00	6,25
333/550	30/4	092298	10	1 000	5,70	7,13

CINKOTIT KUKA ZA NATKROVNI ŽLIJEB

TZ-TZHOBSN



Nominalna veličina	Materijal	EAN broj narudžbe	Pakiranje u kom		Cijena [€/kom]	
					Bez PDV	S PDV
4	25/6	000910	15	300	17,30	21,63

KUTNIK VANJSKI

N-NRCA

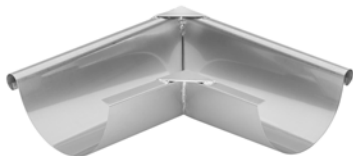

Nominalna veličina	EAN broj narudžbe	Pakiranje u kom		Cijena [€/kom]	
				Bez PDV	S PDV
250	092380 MAFA	2	150	43,00	53,75
280	092397 MAFA	2	150	43,90	54,88
333	092403 MAFA	2	150	45,00	56,25

MAFA – Manufaktura (ručna izrada)

KUTNIK UNUTARNJI

N-NRCI

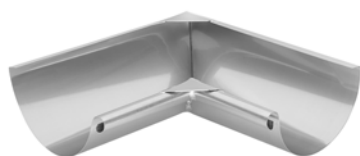

Nominalna veličina	EAN broj narudžbe	Pakiranje u kom		Cijena [€/kom]	
				Bez PDV	S PDV
250	092434 MAFA	2	150	43,00	53,75
280	092441 MAFA	2	150	43,90	54,88
333	092458 MAFA	2	150	45,00	56,25

MAFA – Manufaktura (ručna izrada)

ČELO ŽLIJEBA

N-NCL



Nominalna veličina	EAN broj narudžbe	Pakiranje u kom		Cijena [€/kom]	
				Bez PDV	S PDV
250	092175	6/60	1 440	1,35	1,69
280	092182	6/60	1 440	1,55	1,94
333	092199	6/60	1 440	1,80	2,25

ISPUSNI KOTLIĆ

N-NKL



Nominalna veličina	EAN broj narudžbe	Pakiranje u kom		Cijena [€/kom]	
				Bez PDV	S PDV
250/80	092311	20	600	23,40	29,25
280/100	092328	20	600	25,40	31,75
333/100	092335	20	600	25,80	32,25
333/120	092342	15	300	49,50	61,88



NOVI PRICVRSN
SISTEM FEDER OMOGUĆUJE
LAGANO OKRETANJE KOLIJENA
DO TRAŽENOG SMJERA
TE JE POUZDANO U SVAKOJ
POZICIJI. LAGANA MONTAŽA NA
BILO KAKVO KOLJENO
BEZ NITANJA.



ZADRŽAČ SMEĆA

N-NZN



Nominalna veličina	EAN broj narudžbe	Pakiranje u kom		Cijena [€/kom]	
				Bez PDV	S PDV
60	001153	30	2 160	5,55	6,94
80	001160	20	1 440	5,60	7,00
100	001177	15	1 080	5,70	7,13
120	001184	10	720	6,20	7,75
150	001191	5	360	9,80	12,25



VARENO KOLJENO 72°

N-NK



Nominalna veličina	EAN broj narudžbe	Pakiranje u kom		Cijena [€/kom]	
				Bez PDV	S PDV
60	086600	25	600	8,90	11,13
80	086617	25	400	8,50	10,63
100	086631	25	300	9,95	12,44
120	086655	15	240	14,50	18,13

ZVODOVÉ KOLENO 85°

N-NKR



Nominalna veličina	EAN broj narudžbe	Pakiranje u kom		Cijena [€/kom]	
				Bez PDV	S PDV
80	086624	25	400	10,00	12,50
100	086648	25	300	11,50	14,38
120	086662	15	240	16,20	20,25

VARENO KOLJENO 40°

N-NKT



Nominalna veličina	EAN broj narudžbe	Pakiranje u kom		Cijena [€/kom]	
				Bez PDV	S PDV
80	092359	25	400	9,20	11,50
100	092366	25	300	10,95	13,69
120	092373	15	240	16,00	20,00



ODVODNA CIJEV [s=0,50 mm]

N-NZR

Nominalna veličina	Dužina u m	EAN broj narudžbe	Pakiranje u m		Cijena [€/m]	
					Bez PDV	S PDV
60	2,0	081322	10	490	6,85	8,56
80	3,0	081339	15	270	8,90	11,13
100	3,0	081346	15	180	9,95	12,44
100	4,0	081353	20	240	9,95	12,44
120	3,0	081360	24	144	13,20	16,50
120	4,0	081377	32	192	13,20	16,50



PVC IZLJEVNI RUKAV

SD-ZR FOLIA KJG

Nominalna veličina	Dužina u m	EAN broj narudžbe	Pakiranje u m		Cijena [€/m]	
					Bez PDV	S PDV
60-150	100,0	139726	100	6 000	0,38	0,48

REDUKCIJA CIJEVI 72°

N-NZO



Nominalna veličina	EAN broj narudžbe	Pakiranje u kom		Cijena [€/kom]	
				Bez PDV	S PDV
80/80 *	092489	4	90	20,00	25,00
100/60 *	092496	4	120	20,70	25,88
100/80 *	092502	4	120	21,50	26,88
100/100	092519	4	120	22,00	27,50
120/100	092526	3	90	24,60	30,75
120/120 *	092533	3	90	25,00	31,25

* Proizvodnja po narudžbi

OBUJMICA S NAVOJEM M10

N-NOB





Nominalna veličina	EAN broj narudžbe	Pakiranje u kom		Cijena [€/kom]	
				Bez PDV	S PDV
60	054869	25	3 000	4,00	5,00
80	054876	25	3 000	4,00	5,00
100	054883	25	3 000	4,15	5,19
120	054890	25	3 000	4,50	5,63



VIJAK ZA OBUJMICU M8x30

P-POB-NSK



Nominalna veličina	EAN broj narudžbe	Pakiranje u kom		Cijena [€/kom]	
				Bez PDV	S PDV
M8 x 30 *	139658	1	–	0,25	0,31

* Proizvodnja po narudžbi



VIJAK ZA OBUJMICU TORX M10

P-POB-HT



Nominalna veličina	EAN broj narudžbe	Pakiranje u kom		Cijena [€/kom]	
				Bez PDV	S PDV
80	002464	100	40 000	1,00	1,25
140	002471	100	28 000	1,25	1,56
200	002488	100	20 000	1,55	1,94
250	002495	100	16 000	1,70	2,13
300	002501	100	11 200	1,70	2,13

INOX



TIPLA M10



P-POB-HN DB

Nominalna veličina	EAN broj narudžbe	Pakiranje u kom		Cijena [€/kom]	
				Bez PDV	S PDV
120	002426	100	25 000	0,40	0,50



TIPLA S LAMELOM M10



P-POB-HN DB

Nominalna veličina	EAN broj narudžbe	Pakiranje u kom		Cijena [€/kom]	
				Bez PDV	S PDV
180	002433	100	12 000	0,42	0,53
240	002440	100	12 000	0,50	0,63
280	002457	100	12 000	0,53	0,66



KOMBINIRANI VIJAK TORX M10

P-POB-ZT/SZ

Nominalna veličina	EAN broj narudžbe	Pakiranje u kom		Cijena [€/kom]	
				Bez PDV	S PDV
140	002587	50	10 400	0,45	0,56
180	002594	50	10 400	0,55	0,69



TIPLA ZA IZOLACIJU M10

P-POB-HN IZOL

Nominalna veličina	EAN broj narudžbe	Pakiranje u kom		Cijena [€/kom]	
				Bez PDV	S PDV
M10 x 96	001207	25	2 625	2,70	3,38



KLIN SA PVC TIPLOM ZA OPEKU BEZ IZOLACIJE

P-POB-HN WDV5140 M10

Nominalna veličina	EAN broj narudžbe	Pakiranje u kom		Cijena [€/kom]	
				Bez PDV	S PDV
140	144843	1/5	750	4,80	6,00

INOX



KLIN SA PVC TIPLOM ZA OPEKU SA IZOLACIJOM

P-POB-HN WDV5300 M10

Nominalna veličina	EAN broj narudžbe	Pakiranje u kom		Cijena [€/kom]	
				Bez PDV	S PDV
300	144850	1/5	500	7,80	9,75



UNI NASTAVAK OD NEHRĐAJUČEG ČELIKA ZA PRIČVRŠĆIVANJE OB M10

P-POB-HN PLAT M10

Nominalna veličina	EAN broj narudžbe	Pakiranje u kom		Cijena [€/kom]	
				Bez PDV	S PDV
M10	144836	25/500	5 000	3,35	4,19

NAVOJNA ŠIPKA M10

P-POB-ZT



Nominalna veličina	EAN broj narudžbe	Pakiranje u kom		Cijena [€/kom]	
				Bez PDV	S PDV
60	002556	100	20 800	0,20	0,25
100	002563	100	15 600	0,30	0,38
150	002570	50	10 400	0,55	0,69

MONTAŽNA PLOČICA M10

P-POB-ZT MP



Nominalna veličina	EAN broj narudžbe	Pakiranje u kom		Cijena [€/kom]	
				Bez PDV	S PDV
80 x 30	002518	25	5 200	1,15	1,44

ZAŠTITNI POKLOPAC OBUJMJC

P-POB-HT AKG



Nominalna veličina	EAN broj narudžbe	Pakiranje u kom		Cijena [€/kom]	
				Bez PDV	S PDV
29 x 13	002280	50	16 800	0,25	0,31
29 x 13	002211	50	16 800	0,25	0,31
29 x 13	002235	50	16 800	0,25	0,31
29 x 13	002266	50	16 800	0,25	0,31
29 x 13	002242	50	16 800	0,25	0,31
29 x 13	002228	50	16 800	0,25	0,31
29 x 13	002273	50	16 800	0,25	0,31
29 x 13	002259	50	16 800	0,25	0,31
29 x 13	002297	50	16 800	0,25	0,31





ZADRŽAČ VODE SA SITOM

N-NZVS

Nominalna veličina	EAN broj narudžbe	Pakiranje u kom		Cijena [€/kom]	
				Bez PDV	S PDV
80	035165	6	180	U PROCESU TESTIRANJA	
100	035172	5	240	U PROCESU TESTIRANJA	
120	035189	3	150	U PROCESU TESTIRANJA	



ALUMINIJSKI ZADRŽAČ VODE SA CRIJEVOM

W-WZVHA

Nominalna veličina	EAN broj narudžbe	Pakiranje u kom		Cijena [€/kom]	
				Bez PDV	S PDV
80	001481	1	60	58,50	73,13
120	001504	1	60	112,50	140,63



ALUMINIJSKI ZADRŽAČ VODE SA CRIJEVOM + GUMBOM

W-WZVHAG

Nominalna veličina	EAN broj narudžbe	Pakiranje u kom		Cijena [€/kom]	
				Bez PDV	S PDV
100	001498	1	60	58,50	73,13



POCINČANA ZAŠTITNA CIJEV S REV. OB

P-POZR

Nominalna veličina	Dužina u m	EAN broj narudžbe	Pakiranje u kom		Cijena [€/kom]	
					Bez PDV	S PDV
80	1,0	009708	1	70	60,00	75,00
100	1,0	009715	1	60	45,00	56,25
100	1,5	009722	1	60	89,00	111,25



POCINČANA ZAŠTITNA CIJEV S REV. OB

P-POZR

Nominalna veličina	Dužina u m	EAN broj narudžbe	Pakiranje u kom		Cijena [€/kom]	
					Bez PDV	S PDV
120	1,0	009739	1	40	105,00	131,25
120	1,5	009746	1	40	143,00	178,75

INOX



OBUJMICA S GUMOM M10

P-POB-OZR

Nominalna veličina	EAN broj narudžbe	Pakiranje u kom		Cijena [€/kom]	
				Bez PDV	S PDV
80	002525	25	1 250	1,55	1,94
100	002532	25	1 250	2,00	2,50
120	002549	20	1 000	2,25	2,81

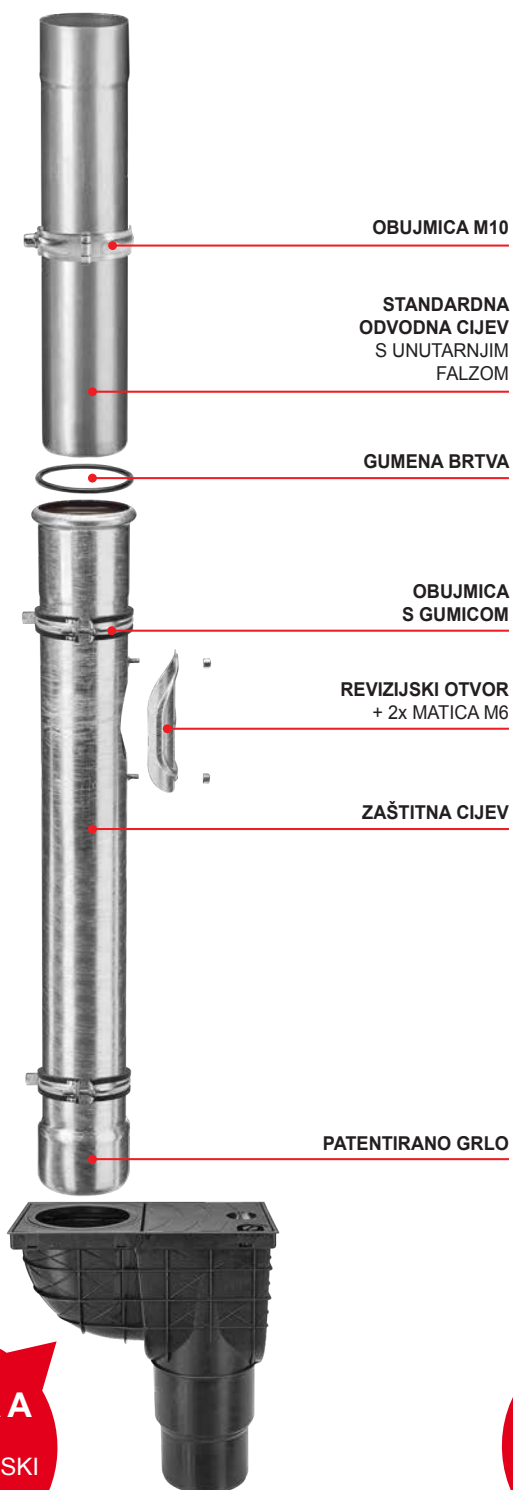

VERZIJA A
PVC
KANALIZACIJSKI
ISPUST

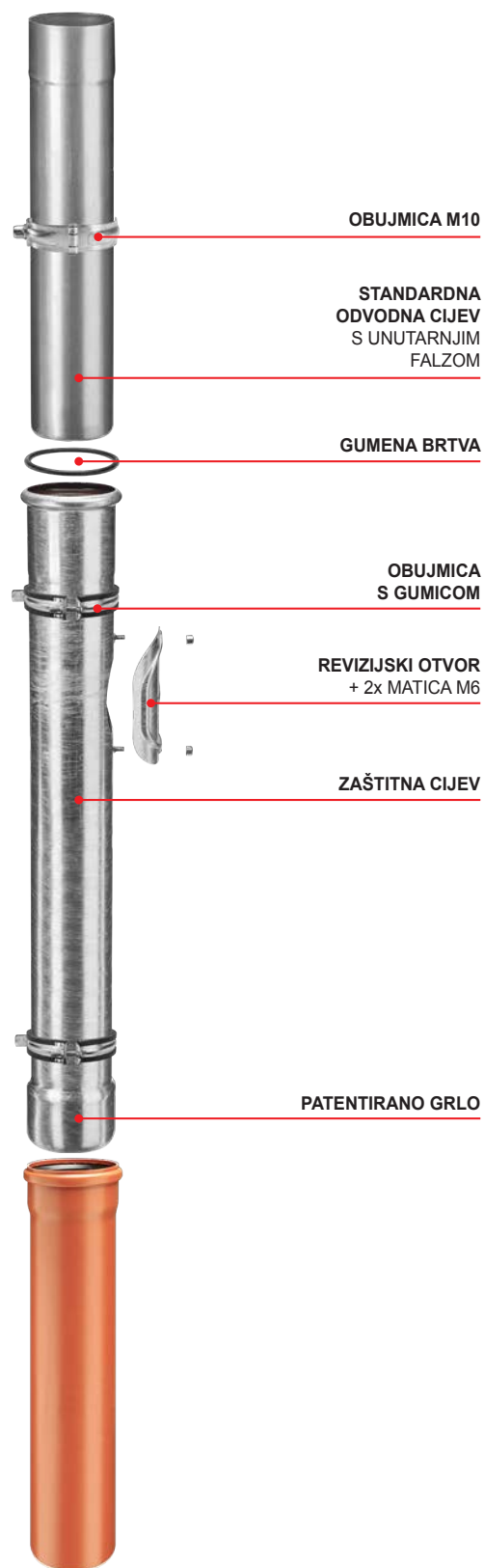

VERZIJA B
PVC
KANALIZACIJSKA
CIJEV

