



POCIN  
KANO

BAR  
VANO

# ŽLEBNI SISTEM POLKROŽNI



**CENIK**  
2024

PRIPOROČENA PRODAJNA CENA



POWERFUL PARTNER FOR YOUR ROOF



Pocinkano material | 3



Žleb | 6



Strešni diletacijski žleb | 14



Žleb oprema | 17



Kljuka | 21



Vogalnik | 26



Zaključek žleba | 28



Kotliček | 30



Koleno | 44



Cev odvodna | 49



Cev odvodna oprema | 58



Objemka | 61

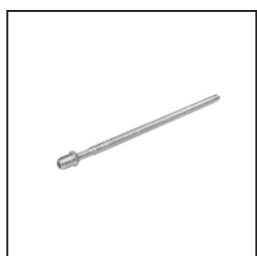

Objemka oprema | 65



Lovilec vode | 68



Zaščitna cev | 72

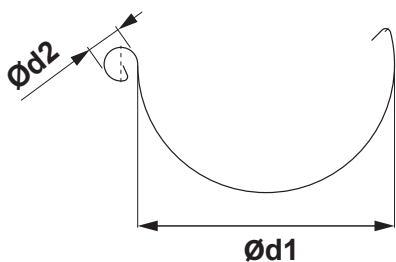

## DIMENZIJE STREŠNIH ŽLEBOV

(dimenzije in toleranca po EN 612)

Razvita širina (mm)	200	250	280	333	400	500
Ød1	80	105	127	153	192	250
Ød2	16	18	18	20	22	22

## NOTRANJI ZGIB

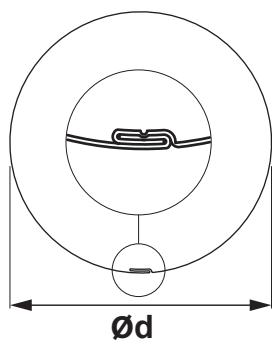

## DIMENZIJE STREŠNIH ODOČNIH CEVI

(dimenzije in toleranca po EN 612)

Dimenzije	60	80	100	120	150
Imenska velikost Ød (mm)	60	80	100	120	150

## DIMENZIJE STREŠNIH KAVLJEV

(dimenzije in toleranca po EN 612)

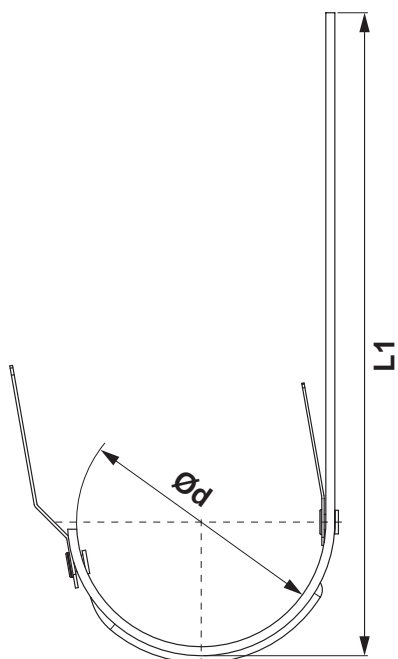

Dimenzije (mm)	L1	Ød
200	290	80
250	310	105
280	345	127
333 – 550	385	153
333 – 610	445	153
400	400	192

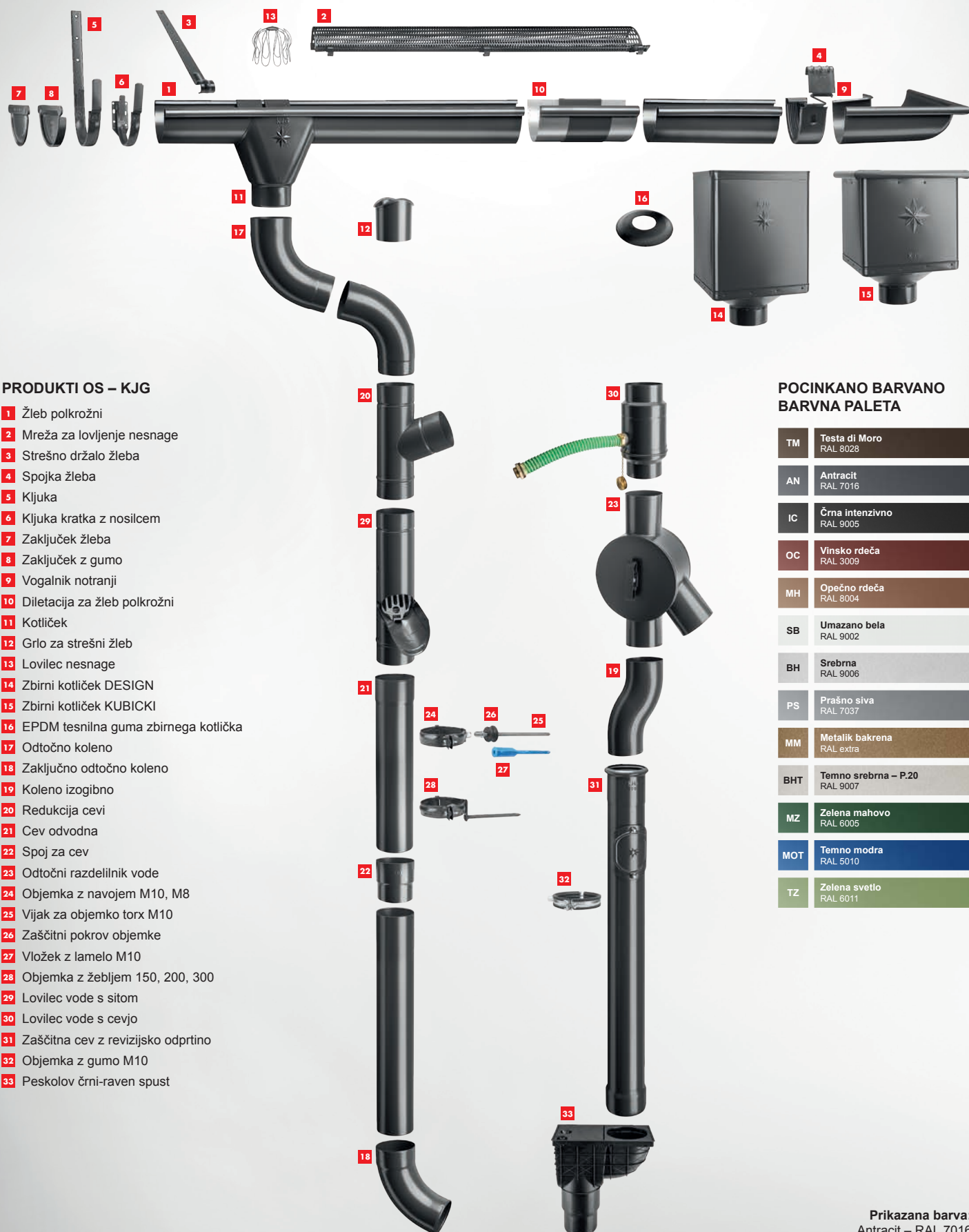

**PRODUKTI OS – KJG**

- 1** Žleb polkrožni
- 2** Mreža za lovljenje nesnage
- 3** Strešno držalo žleba
- 4** Spojka žleba
- 5** Kljuka
- 6** Kljuka kratka z nosilcem
- 7** Zaključek žleba
- 8** Zaključek z gumo
- 9** Vogalnik notranji
- 10** Diletacija za žleb polkrožni
- 11** Kottiček
- 12** Grlo za strešni žleb
- 13** Lovilec nesnage
- 14** Zbirni kottiček DESIGN
- 15** Zbirni kottiček KUBICKI
- 16** EPDM tesnilna guma zbirnega kottička
- 17** Odtočno koleno
- 18** Zaključno odtočno koleno
- 19** Koleno izogibno
- 20** Redukcija cevi
- 21** Cev odvodna
- 22** Spoj za cev
- 23** Odtočni razdelilnik vode
- 24** Objemka z navojem M10, M8
- 25** Vijak za objemko torx M10
- 26** Zaščitni pokrov objemke
- 27** Vložek z lamelo M10
- 28** Objemka z žebljem 150, 200, 300
- 29** Lovilec vode s sitom
- 30** Lovilec vode s cevjo
- 31** Zaščitna cev z revizijsko odprtino
- 32** Objemka z gumo M10
- 33** Peskolov črni-raven spust

**POCINKANO BARVANO  
BARVNA PALETA**

TM	Testa di Moro RAL 8028
AN	Antracit RAL 7016
IC	Črna intenzivno RAL 9005
OC	Vinsko rdeča RAL 3009
MH	Opečno rdeča RAL 8004
SB	Umazano bela RAL 9002
BH	Srebrna RAL 9006
PS	Prašno siva RAL 7037
MM	Metalik bakrena RAL extra
BHT	Temno srebrna – P.20 RAL 9007
MZ	Zelena mahovo RAL 6005
MOT	Temno modra RAL 5010
TZ	Zelena svetlo RAL 6011

## TATA STEEL





Družbo Tata je leta 1868 ustanovila družba Jamsetji Nusserwanji Tata s sedežem v Indiji. Je globalni poslovni konglomerat, ki deluje v več kot 100 državah na petih kontinentih. Od zgodnjega vstopa v industrijo jekla in avtomobilov, za namen ohranjanja koraka z najnovejšimi tehnologijami, ima danes skupina Tata močan položaj v različnih panogah, kot so fitofarmaceutvska sredstva, avtomobilska industrija, kemikalije, gradbeništvo, finance, izdelki široke porabe in gostinstvo.

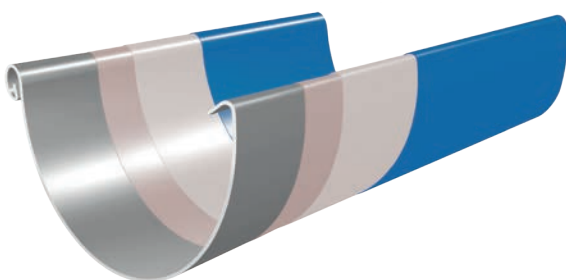

## MARCEGAGLIA

Marcegaglia je vodilni igralec v Italiji in največji neodvisni globalni operator v jeklarski industriji. Vsako leto predela 5,6 milijona ton, s prometom več kot 5 milijard evro (2017) je Marcegaglia italijanska industrijska skupina, ki je vodilni igralec v Evropi in celem svetu. Pridobljeno vodstvo je rezultat dolge, trdne in stabilne rasti, ki dela iz družbe Marcegaglia največjega neodvisnega globalnega igralca v predelavi jekla.



-  Zgornji sloj je lak (cca 20  $\mu\text{m}$ ) na osnovi poliestra za odličen izgled in izvrstno odpornost na praske
-  Primer (cca 5  $\mu\text{m}$ ) za odlično prileganje in močno zaščito proti koroziji
-  Sloj cinka (225 g/m<sup>2</sup>) za trajno zaščito proti koroziji
-  Jeklena pločevina optimizirana za proizvodnjo odvodnega sistema OS – KJG

# POCINKANO POLYESTER

## ŽLEB POLKROŽNI [s=0,55]

P-PZ

Nominalna velikost	200		200		200	
	2,0		3,0		4,0	
Dolžina v m	2,0		3,0		4,0	
Cena v €/m	Brez DDV	Z DDV	Brez DDV	Z DDV	Brez DDV	Z DDV
<b>TM</b> 1 Testa di Moro RAL 8028	6,95	8,48	6,95	8,48	6,95	8,48
	043610		043627		043634	
<b>AN</b> 2 Antracit RAL 7016	6,95	8,48	6,95	8,48	6,95	8,48
	042187		042194		042200	
<b>IC</b> 3 Črna intenzivno RAL 9005	6,95	8,48	6,95	8,48	6,95	8,48
	042545		042552		042569	
<b>OC</b> 4 Vinsko rdeča RAL 3009			6,95	8,48	6,95	8,48
			043191		043207	
<b>MH</b> 5 Opečno rdeča RAL 8004			7,05	8,60		
			042750			
<b>SB</b> 6 Umazano bela RAL 9002			7,05	8,60		
			043498			
<b>BH</b> 7 Srebrna RAL 9006			7,05	8,60	7,05	8,60
			042392		042408	
<b>PS</b> 8 Prašno siva RAL 7037			7,05	8,60	7,05	8,60
			043375		043382	
<b>MM</b> 9 Metalik bakrena RAL extra			7,50	9,15		
			042927			
<b>BHT – P.20</b> 10 Temno srebrna RAL 9007						
<b>MZ</b> 11 Zelena mahovo RAL 6005			7,50	9,15		
			043085			
<b>MOT</b> 12 Temno modra RAL 5010			7,50	9,15		
			043016 *			
<b>TZ</b> 13 Zelena svetlo RAL 6011			7,50	9,15		
			043825 *			
<b>Pakiranje v m</b> 			15			
<b>Pakiranje v m</b> 	800		1 200		1 600	

\* Izdelava po meri

POCINKANO  
POLYESTER



## ŽLEB POLKROŽNI [s=0,55]

P-PZ

Nominalna velikost	250		250		250		250		250		
Dolžina v m	2,0		3,0		4,0		5,0		6,0		
Cena v €/m	Brez DDV	Z DDV	Brez DDV	Z DDV	Brez DDV	Z DDV	Brez DDV	Z DDV	Brez DDV	Z DDV	
<b>TM</b> Testa di Moro RAL 8028	1	6,20	<b>7,56</b>	6,05	<b>7,38</b>	6,05	<b>7,38</b>	6,05	<b>7,38</b>	6,05	<b>7,38</b>
		043641		043658		043665		043672		043689	
<b>AN</b> Antracit RAL 7016	2	6,20	<b>7,56</b>	6,05	<b>7,38</b>	6,05	<b>7,38</b>	6,05	<b>7,38</b>	6,05	<b>7,38</b>
		042217		042224		042231		042248		042255	
<b>IC</b> Črna intenzivno RAL 9005	3	6,20	<b>7,56</b>	6,05	<b>7,38</b>	6,05	<b>7,38</b>	6,05	<b>7,38</b>	6,05	<b>7,38</b>
		042576		042583		042590		042606		042613	
<b>OC</b> Vinsko rdeča RAL 3009	4	6,20	<b>7,56</b>	6,05	<b>7,38</b>	6,05	<b>7,38</b>	6,05	<b>7,38</b>	6,05	<b>7,38</b>
		043214		043221		043238		043245		043252	
<b>MH</b> Opečno rdeča RAL 8004	5	6,30	<b>7,69</b>	6,15	<b>7,50</b>	6,15	<b>7,50</b>	6,15	<b>7,50</b>	6,15	<b>7,50</b>
		042774		042781		042798		042804		042811	
<b>SB</b> Umazano bela RAL 9002	6			6,15	<b>7,50</b>	6,15	<b>7,50</b>			6,15	<b>7,50</b>
				043504		043511				043528	
<b>BH</b> Srebrna RAL 9006	7			6,15	<b>7,50</b>	6,15	<b>7,50</b>	6,15	<b>7,50</b>	6,15	<b>7,50</b>
				042415		042422		042439		042446	
<b>PS</b> Prašno siva RAL 7037	8					6,15	<b>7,50</b>			6,15	<b>7,50</b>
						043399				043405	
<b>MM</b> Metalik bakrena RAL extra	9					6,50	<b>7,93</b>			6,50	<b>7,93</b>
						042934				042941	
<b>BHT – P.20</b> Temno srebrna RAL 9007	10					7,50	<b>9,15</b>				
						095466					
<b>MZ</b> Zelena mahovo RAL 6005	11					6,50	<b>7,93</b>			6,50	<b>7,93</b>
						043092				043108	
<b>MOT</b> Temno modra RAL 5010	12					6,50	<b>7,93</b>				
						043023					
<b>TZ</b> Zelena svetlo RAL 6011	13					6,50	<b>7,93</b>				
						043832					
<b>Pakiranje v m</b> 📦											
<b>Pakiranje v m</b> 🚚		<b>480</b>		<b>720</b>		<b>960</b>		<b>1 200</b>		<b>1 440</b>	



# POCINKANO POLYESTER

## ŽLEB POLKROŽNI [s=0,55]

P-PZ

Nominalna velikost	280		280		280		280		280		
Dolžina v m	2,0		3,0		4,0		5,0		6,0		
Cena v €/m	Brez DDV	Z DDV	Brez DDV	Z DDV	Brez DDV	Z DDV	Brez DDV	Z DDV	Brez DDV	Z DDV	
<b>TM</b> Testa di Moro RAL 8028	1	7,00	8,54	6,85	8,36	6,85	8,36	6,85	8,36	6,85	8,36
		043696		043702		043719		043726		043733	
<b>AN</b> Antracit RAL 7016	2	7,00	8,54	6,85	8,36	6,85	8,36	6,85	8,36	6,85	8,36
		042262		042279		042286		042293		042309	
<b>IC</b> Črna intenzivno RAL 9005	3	7,00	8,54	6,85	8,36	6,85	8,36	6,85	8,36	6,85	8,36
		042620		042637		042644		042651		042668	
<b>OC</b> Vinsko rdeča RAL 3009	4			6,85	8,36	6,85	8,36	6,85	8,36	6,85	8,36
				043269		043276		043283		043290	
<b>MH</b> Opečno rdeča RAL 8004	5			6,95	8,48	6,95	8,48			6,95	8,48
				042828		042835				042842	
<b>SB</b> Umazano bela RAL 9002	6					6,95	8,48			6,95	8,48
						043535				043542	
<b>BH</b> Srebrna RAL 9006	7			6,95	8,48	6,95	8,48			6,95	8,48
				042453		042460				042477	
<b>PS</b> Prašno siva RAL 7037	8					6,95	8,48			6,95	8,48
						043412				043429	
<b>MM</b> Metalik bakrena RAL extra	9					7,45	9,09			7,45	9,09
						042958				042965	
<b>BHT – P.20</b> Temno srebrna RAL 9007	10					8,40	10,25				
						095473					
<b>MZ</b> Zelena mahovo RAL 6005	11					7,45	9,09			7,45	9,09
						043115				043122	
<b>MOT</b> Temno modra RAL 5010	12					7,45	9,09				
						043030					
<b>TZ</b> Zelena svetlo RAL 6011	13					7,45	9,09				
						043849					
<b>Pakiranje v m</b> 						20		25			
<b>Pakiranje v m</b> 		420		630		840		1 050		1 260	

POCINKANO  
POLYESTER





# POCINKANO POLYESTER

## ŽLEB POLKROŽNI [s=0,55]

P-PZ

Nominalna velikost	333		333		333		333		333		
Dolžina v m	2,0		3,0		4,0		5,0		6,0		
Cena v €/m	Brez DDV	Z DDV	Brez DDV	Z DDV	Brez DDV	Z DDV	Brez DDV	Z DDV	Brez DDV	Z DDV	
<b>TM</b> Testa di Moro RAL 8028	1	7,30	<b>8,91</b>	7,10	<b>8,66</b>	7,10	<b>8,66</b>	7,10	<b>8,66</b>	7,10	<b>8,66</b>
		043740		043757		043764		043771		043788	
<b>AN</b> Antracit RAL 7016	2	7,30	<b>8,91</b>	7,10	<b>8,66</b>	7,10	<b>8,66</b>	7,10	<b>8,66</b>	7,10	<b>8,66</b>
		042316		042323		042330		042347		042354	
<b>IC</b> Črna intenzivno RAL 9005	3	7,30	<b>8,91</b>	7,10	<b>8,66</b>	7,10	<b>8,66</b>	7,10	<b>8,66</b>	7,10	<b>8,66</b>
		042675		042682		042699		042705		042712	
<b>OC</b> Vinsko rdeča RAL 3009	4	7,30	<b>8,91</b>	7,10	<b>8,66</b>	7,10	<b>8,66</b>	7,10	<b>8,66</b>	7,10	<b>8,66</b>
		043306		043313		043320		043337		043344	
<b>MH</b> Opečno rdeča RAL 8004	5	7,40	<b>9,03</b>	7,20	<b>8,78</b>	7,20	<b>8,78</b>	7,20	<b>8,78</b>	7,20	<b>8,78</b>
		042859		042866		042873		042880		042897	
<b>SB</b> Umazano bela RAL 9002	6			7,20	<b>8,78</b>	7,20	<b>8,78</b>	7,20	<b>8,78</b>	7,20	<b>8,78</b>
				043559		043566		043573		043580	
<b>BH</b> Srebrna RAL 9006	7			7,20	<b>8,78</b>	7,20	<b>8,78</b>	7,20	<b>8,78</b>	7,20	<b>8,78</b>
				042484		042491		042507		042514	
<b>PS</b> Prašno siva RAL 7037	8			7,20	<b>8,78</b>	7,20	<b>8,78</b>	7,20	<b>8,78</b>	7,20	<b>8,78</b>
				043436		043443		043450		043467	
<b>MM</b> Metalik bakrena RAL extra	9					8,30	<b>10,13</b>	8,30	<b>10,13</b>	8,30	<b>10,13</b>
						042972		042989		042996	
<b>BHT – P.20</b> Temno srebrna RAL 9007	10					8,50	<b>10,37</b>			8,50	<b>10,37</b>
						095480				095497	
<b>MZ</b> Zelena mahovo RAL 6005	11					8,30	<b>10,13</b>	8,30	<b>10,13</b>	8,30	<b>10,13</b>
						043139		043146		043153	
<b>MOT</b> Temno modra RAL 5010	12					8,30	<b>10,13</b>			8,30	<b>10,13</b>
						043047				043054	
<b>TZ</b> Zelena svetlo RAL 6011	13					8,30	<b>10,13</b>				
						043856					
<b>Pakiranje v m</b> 		10				20		25		30	
<b>Pakiranje v m</b> 		330		495		660		825		990	



# POCINKANO POLYESTER

## ŽLEB POLKROŽNI [s=0,55]

P-PZ

Nominalna velikost	400		400		500		500		333		
Dolžina v m	4,0		6,0		4,0		6,0		7,0		
Cena v €/m	Brez DDV	Z DDV	Brez DDV	Z DDV	Brez DDV	Z DDV	Brez DDV	Z DDV	Brez DDV	Z DDV	
<b>TM</b> Testa di Moro RAL 8028	1	11,45	13,97	11,45	13,97					7,10	8,66
		043801		043818						043795 *	
<b>AN</b> Antracit RAL 7016	2	11,45	13,97	11,45	13,97	15,50	18,91	15,50	18,91		
		042361		042378		086730 *		086747 *			
<b>IC</b> Črna intenzivno RAL 9005	3	11,45	13,97	11,45	13,97						
		042729		042736							
<b>OC</b> Vinsko rdeča RAL 3009	4	11,45	13,97	11,45	13,97						
		043351		043368							
<b>MH</b> Opečno rdeča RAL 8004	5	11,55	14,09	11,55	14,09						
		042903		042910							
<b>SB</b> Umazano bela RAL 9002	6	11,55	14,09	11,55	14,09	15,60	19,03	15,60	19,03		
		043597		043603		086778 *		086785 *			
<b>BH</b> Srebrna RAL 9006	7	11,55	14,09	11,55	14,09	15,60	19,03	15,60	19,03		
		042521		042538		086754 *		086761 *			
<b>PS</b> Prašno siva RAL 7037	8	11,55	14,09	11,55	14,09						
		043474		043481							
<b>MM</b> Metalik bakrena RAL extra	9	12,15	14,82								
		043009									
<b>BHT – P.20</b> Temno srebrna RAL 9007	10			12,80	15,62						
				095503							
<b>MZ</b> Zelena mahovo RAL 6005	11	12,15	14,82	12,15	14,82						
		043160		043177 *							
<b>MOT</b> Temno modra RAL 5010	12	12,15	14,82	12,15	14,82						
		043061		043078							
<b>TZ</b> Zelena svetlo RAL 6011	13	12,15	14,82								
		043863 *									
<b>Pakiranje v m</b> 		20		30						35	
<b>Pakiranje v m</b> 		540		810		-		-		1 155	

\* Izdelava po meri

POCINKANO  
POLYESTER



# POCINKANO POLYESTER

## ŽLEB POLKROŽNI [s=0,50]

P-PZ

Nominalna velikost	250		250		250		250		250		
Dolžina v m	2,0		3,0		4,0		5,0		6,0		
Cena v €/m	Brez DDV		Brez DDV		Brez DDV		Brez DDV		Brez DDV		
<b>TM</b> Testa di Moro RAL 8028	1	5,30	6,47	5,30	6,47	5,30	6,47	5,30	6,47	5,30	6,47
		069184 *		069191		069207		069009 *		069214 *	
<b>AN</b> Antracit RAL 7016	2			4,70	5,73	4,70	5,73	4,70	5,73	4,70	5,73
				068729		068736		068743 *		068750 *	
<b>IC</b> Črna intenzivno RAL 9005	3			5,30	6,47	5,30	6,47	5,30	6,47	5,30	6,47
				068965		068972		068989 *		068996 *	
<b>OC</b> Vinsko rdeča RAL 3009	4			5,30	6,47	5,30	6,47	5,30	6,47	5,30	6,47
				069108 *		069115		069122 *		069139 *	
<b>BH</b> Srebrna RAL 9006	5			5,30	6,47	5,30	6,47	5,30	6,47	5,30	6,47
				068842 *		068859		068866 *		068873 *	
<b>TH</b> Tmavo hreda ČOKO RAL 8017	6			5,30	6,47	5,30	6,47			5,30	6,47
				084774 *		084781				084804 *	
<b>MH</b> Opečno rdeča RAL 8004	9			5,30	6,47	5,30	6,47	5,30	6,47	5,30	6,47
				084934 *		84941		084958 *		084965 *	
Pakiranje v m		10		15		20		25		30	
Pakiranje v m		480		720		960		1 200		1 440	

\* Izdelava po meri

## ŽLEB POLKROŽNI [s=0,50]

P-PZ

Nominalna velikost	280		280		280		280		
Dolžina v m	3,0		4,0		5,0		6,0		
Cena v €/m	Brez DDV		Brez DDV		Brez DDV		Brez DDV		
<b>TM</b> Testa di Moro RAL 8028	1	5,80	7,08	5,80	7,08	5,80	7,08	5,80	7,08
		069238 *		069245		069252 *		069269 *	
<b>AN</b> Antracit RAL 7016	2	5,15	6,28	5,15	6,28	5,15	6,28	5,15	6,28
		068767 *		068774		068781 *		068798 *	
<b>IC</b> Črna intenzivno RAL 9005	3	5,80	7,08	5,80	7,08	5,80	7,08	5,80	7,08
		069016 *		069023		069030 *		069047 *	
<b>OC</b> Vinsko rdeča RAL 3009	4	5,80	7,08	5,80	7,08	5,80	7,08	5,80	7,08
		069054 *		084767		084811 *		084866 *	
<b>BH</b> Srebrna RAL 9006	5	5,80	7,08	5,80	7,08	5,80	7,08	5,80	7,08
		068880 *		068897		068903 *		068910 *	
<b>TH</b> Tmavo hreda ČOKO RAL 8017	6			5,80	7,08			5,80	7,08
				084835 *				084859 *	
<b>MH</b> Opečno rdeča RAL 8004	9	5,80	7,08	5,80	7,08	5,80	7,08	5,80	7,08
		084989 *		084996		085009 *		085016 *	
Pakiranje v m		15		20		25		30	
Pakiranje v m		630		840		1 050		1 260	

\* Izdelava po meri

# POCINKANO POLYESTER

## ŽLEB POLKROŽNI [s=0,50]

P-PZ

Nominalna velikost	333		333		333	
Dolžina v m	2,0		3,0		4,0	
Cena v €/m	Brez DDV	Z DDV	Brez DDV	Z DDV	Brez DDV	Z DDV
<b>TM</b> Testa di Moro RAL 8028	6,50	<b>7,93</b>	6,50	<b>7,93</b>	6,50	<b>7,93</b>
	069276 *		069283 *		069290	
<b>AN</b> Antracit RAL 7016			5,75	<b>7,02</b>	5,75	<b>7,02</b>
			068804 *		068811	
<b>IC</b> Črna intenzivno RAL 9005			6,50	<b>7,93</b>	6,50	<b>7,93</b>
			069061 *		069078	
<b>OC</b> Vinsko rdeča RAL 3009			6,50	<b>7,93</b>	6,50	<b>7,93</b>
			069146 *		069153	
<b>BH</b> Srebrna RAL 9006			6,50	<b>7,93</b>	6,50	<b>7,93</b>
			068927 *		068934	
<b>TH</b> Tmavo hredá ČOKO RAL 8017			6,50	<b>7,93</b>	6,50	<b>7,93</b>
			084873 *		084880	
<b>MH</b> Opečno rdeča RAL 8004			6,50	<b>7,93</b>	6,50	<b>7,93</b>
			085030 *		085047	
<b>Pakiranje v m</b>	<b>10</b>		<b>15</b>		<b>20</b>	
<b>Pakiranje v m</b>	<b>330</b>		<b>495</b>		<b>660</b>	

\* Izdelava po meri

## ŽLEB POLKROŽNI [s=0,50]

P-PZ

Nominalna velikost	333		333		333	
Dolžina v m	5,0		6,0		7,0	
Cena v €/m	Brez DDV	Z DDV	Brez DDV	Z DDV	Brez DDV	Z DDV
<b>TM</b> Testa di Moro RAL 8028	6,50	<b>7,93</b>	6,50	<b>7,93</b>	6,50	<b>7,93</b>
	069306 *		069313 *		069320 *	
<b>AN</b> Antracit RAL 7016	5,75	<b>7,02</b>	5,75	<b>7,02</b>		
	068828 *		068835 *			
<b>IC</b> Črna intenzivno RAL 9005	6,50	<b>7,93</b>	6,50	<b>7,93</b>		
	069085 *		069092 *			
<b>OC</b> Vinsko rdeča RAL 3009	6,50	<b>7,93</b>	6,50	<b>7,93</b>		
	069160 *		069177 *			
<b>BH</b> Srebrna RAL 9006	6,50	<b>7,93</b>	6,50	<b>7,93</b>		
	068941 *		068958 *			
<b>TH</b> Tmavo hredá ČOKO RAL 8017	6,50	<b>7,93</b>	6,50	<b>7,93</b>		
	084897		084903			
<b>MH</b> Opečno rdeča RAL 8004	6,50	<b>7,93</b>	6,50	<b>7,93</b>		
	085054 *		085061 *			
<b>Pakiranje v m</b>	<b>25</b>		<b>30</b>		<b>35</b>	
<b>Pakiranje v m</b>	<b>825</b>		<b>990</b>		<b>1 155</b>	

\* Izdelava po meri

**ŽLEB LEŽEČI [s=0,55]**
**P-PZS**

Nominalna velikost	650		650	
Dolžina v m	4,0		6,0	
Cena v €/m	Brez DDV	Z DDV	Brez DDV	Z DDV
<b>TM</b> Testa di Moro RAL 8028	24,50	<b>29,89</b>	24,50	<b>29,89</b>
	049926		049933	
<b>AN</b> Antracit RAL 7016	24,50	<b>29,89</b>	24,50	<b>29,89</b>
	049759		049766	
<b>IC</b> Črna intenzivno RAL 9005	24,50	<b>29,89</b>	24,50	<b>29,89</b>
	049797		049803	
<b>OC</b> Vinsko rdeča RAL 3009	24,50	<b>29,89</b>	24,50	<b>29,89</b>
	049865		049872	
<b>MH</b> Opečno rdeča RAL 8004	25,50	<b>31,11</b>	25,50	<b>31,11</b>
	049810		049827	
<b>SB</b> Umazano bela RAL 9002	25,50	<b>31,11</b>		
	049902			
<b>BH</b> Srebrna RAL 9006	25,50	<b>31,11</b>	25,50	<b>31,11</b>
	049773		049780	
<b>PS</b> Prašno siva RAL 7037	25,50	<b>31,11</b>		
	049889			
<b>MM</b> Metalik bakrena RAL extra	28,00	<b>34,16</b>		
	049834			
<b>BHT – P.20</b> Temno srebrna RAL 9007	32,50	<b>39,65</b>		
	095749 *			
<b>MZ</b> Zelena mahovo RAL 6005	28,00	<b>34,16</b>		
	049858			
<b>MOT</b> Temno modra RAL 5010	28,00	<b>34,16</b>		
	049841 *			
<b>TZ</b> Zelena svetlo RAL 6011	28,00	<b>34,16</b>		
	049940 *			
<b>Pakiranje v m</b> 	<b>4</b>		<b>6</b>	
<b>Pakiranje v m</b> 	<b>200</b>		<b>300</b>	

\* Izdelava po meri



## DILETACIJA ZA ŽLEB POLKROŽNI

P-PZDI

Nominalna velikost	250/260		280/260		333/260		400/260	
	Brez DDV	Z DDV	Brez DDV	Z DDV	Brez DDV	Z DDV	Brez DDV	Z DDV
<b>TM</b> 1 Testa di Moro RAL 8028	14,60	<b>17,81</b>	15,50	<b>18,91</b>	16,90	<b>20,62</b>	19,90	<b>24,28</b>
	013064		013071		013088		013095	
<b>AN</b> 2 Antracit RAL 7016	14,60	<b>17,81</b>	15,50	<b>18,91</b>	16,90	<b>20,62</b>	19,90	<b>24,28</b>
	012661		012678		012685		012692	
<b>IC</b> 3 Črna intenzivno RAL 9005	14,60	<b>17,81</b>	15,50	<b>18,91</b>	16,90	<b>20,62</b>	19,90	<b>24,28</b>
	012746 *		012753 *		012760		012777 *	
<b>OC</b> 4 Vinsko rdeča RAL 3009	14,60	<b>17,81</b>	15,50	<b>18,91</b>	16,90	<b>20,62</b>	19,90	<b>24,28</b>
	012944 *		012951 *		012968 *		012975 *	
<b>MH</b> 5 Opečno rdeča RAL 8004	14,60	<b>17,81</b>	15,50	<b>18,91</b>	16,90	<b>20,62</b>	19,90	<b>24,28</b>
	012784 *		012791 *		012807 *		012814 *	
<b>SB</b> 6 Umazano bela RAL 9002	14,60	<b>17,81</b>	15,50	<b>18,91</b>	16,90	<b>20,62</b>	19,90	<b>24,28</b>
	013026 *		013033 *		013040 *		013057 *	
<b>BH</b> 7 Srebrna RAL 9006	14,60	<b>17,81</b>	15,50	<b>18,91</b>	16,90	<b>20,62</b>	19,90	<b>24,28</b>
	012708 *		012715 *		012722 *		012739 *	
<b>PS</b> 8 Prašno siva RAL 7037	14,60	<b>17,81</b>	15,50	<b>18,91</b>	16,90	<b>20,62</b>	19,90	<b>24,28</b>
	012982 *		012999 *		013002 *		013019 *	
<b>MM</b> 9 Metalik bakrena RAL extra	14,60	<b>17,81</b>	15,50	<b>18,91</b>	16,90	<b>20,62</b>	19,90	<b>24,28</b>
	012821 *		012838 *		012845 *		012852 *	
<b>BHT – P.20</b> 10 Temno srebrna RAL 9007	14,60	<b>17,81</b>	15,50	<b>18,91</b>	16,90	<b>20,62</b>	19,90	<b>24,28</b>
	096098 *		096104 *		096111 *		114044 *	
<b>MZ</b> 11 Zelena mahovo RAL 6005	14,60	<b>17,81</b>	15,50	<b>18,91</b>	16,90	<b>20,62</b>	19,90	<b>24,28</b>
	012906 *		012913 *		012920 *		012937 *	
<b>MOT</b> 12 Temno modra RAL 5010	14,60	<b>17,81</b>	15,50	<b>18,91</b>	16,90	<b>20,62</b>	19,90	<b>24,28</b>
	012869 *		012876 *		012883 *		012890 *	
<b>TZ</b> 13 Zelena svetlo RAL 6011	14,60	<b>17,81</b>	15,50	<b>18,91</b>	16,90	<b>20,62</b>	19,90	<b>24,28</b>
	013101 *		013118 *		013125 *		013132 *	
<b>Pakiranje v kos</b> 	<b>3</b>		<b>3</b>		<b>5</b>		<b>5</b>	
<b>Pakiranje v kos</b> 	<b>360</b>		<b>360</b>		<b>200</b>		<b>200</b>	

\* Izdelava po meri

POCINKANO  
POLYESTER

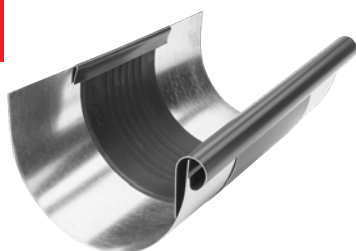

## DILETACIJA ZA LEŽEČI ŽLEB

P-PZSDI



Nominalna velikost	670/260	
Cena v €/kos	Brez DDV	Z DDV
<b>TM</b> 1 Testa di Moro RAL 8028	31,50	38,43
	013637 *	
<b>AN</b> 2 Antracit RAL 7016	31,50	38,43
	013545 *	
<b>IC</b> 3 Črna intenzivno RAL 9005	31,50	38,43
	013569 *	
<b>OC</b> 4 Vinsko rdeča RAL 3009	31,50	38,43
	013606 *	
<b>MH</b> 5 Opečno rdeča RAL 8004	31,50	38,43
	013576 *	
<b>SB</b> 6 Umazano bela RAL 9002	31,50	38,43
	013620 *	
<b>BH</b> 7 Srebrna RAL 9006	31,50	38,43
	013552 *	
<b>PS</b> 8 Prašno siva RAL 7037	31,50	38,43
	013613 *	
<b>MM</b> 9 Metalik bakrena RAL extra	31,50	38,43
	013583 *	
<b>BHT – P.20</b> 10 Temno srebrna RAL 9007	31,50	38,43
	096067 *	
<b>MZ</b> 11 Zelena mahovo RAL 6005	31,50	38,43
	013651 *	
<b>MOT</b> 12 Temno modra RAL 5010	31,50	38,43
	013590 *	
<b>TZ</b> 13 Zelena svetlo RAL 6011	31,50	38,43
	013644 *	
<b>Pakiranje v kos</b>	1	
<b>Pakiranje v kos</b>	40	

\* Izdelava po meri

## DILETACIJSKI TRAK

P-PZDIP



Nominalna velikost	Dolžina v m	EAN številko izdelka	Pakiranje v m		Cena [€/m]	
					Brez DDV	Z DDV
260	3,0	012470	3	120	33,60	40,99
260	6,0	012487	6	240	33,60	40,99

## UPORABA DILATACIJSKEGA ŽLEBA IN DILATACIJSKEGA TRAKU

### DILATACIJSKI ŽLEB

**Primer montaže: Razvite širine do 500 mm.** Dilatacijski žleb mora biti nameščen z razmikom 15 m. Za zunanji vogal in začetek žleba velja polovica standardne vrednosti: največ 7,5 m. Za notranji vogal velja četrtina standardne vrednosti: največ 3,75 m. Za druge materiale in dimenzije: glej tabelo spodaj. Vogali vedno štejejo kot fiksne točke.

### DILATACIJSKI TRAK

Notranja namestitvev: na žlebove pritrjen brez lepljenja na podlago, strehe z nestandardnim profilom in pločevinsko obrobo zidov

### STREŠNI POLOGLATI DILATACIJSKI ŽLEBOVI

Razvita širina žleba	Aluminij	Pocinkano, Cinkotit, Baker, Inox
< 500	12	15
> 500	8	10

### STREŠNI DILATACIJSKI TRAK

Razvita širina žleba	Aluminij	Pocinkano, Cinkotit, Baker, Inox
< 500	8	10
> 500	6	8

Za zunanji vogal ali začetek žleba velja polovica standardne vrednosti. Za notranji vogal velja ena četrtina standardne vrednosti.

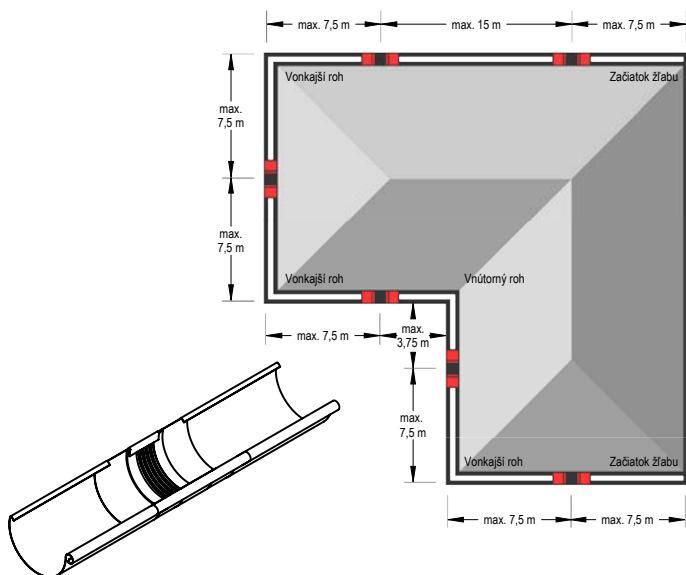

#### Opomba za montažo dilatacijskega žleba

Pri montaži s spajkanjem najprej srednji gumijasti del pokrijte z mokro krpo (da ne pride do prehoda toplotev srednji gumijasti del). Upoštevati je potrebno minimalno razdaljo 6 cm od srednjega gumijastega dela. V vsakem primeru se izogibajte kontaktu gume z odprtim ognjem.

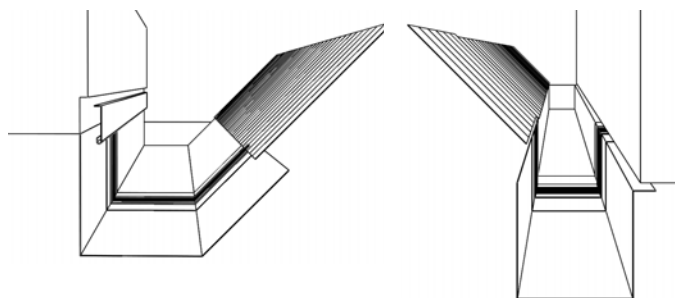

#### Opomba za montažo dilatacijskega traku

Pri krivljenju in montaži dilatacijskih elementov preverite, ali:

- je radij čeljusti za krivljenje vsaj 2 mm.
- Za debelino pločevine od 1 mm mora biti polmer krivljenja vsaj 5 mm.
- Čeljusti morajo biti za krivljenje nastavljene v debelini srednjega gumijastega dela 3 do 4 mm, da se prepreči učinek rezanja – poškodovanja gume.
- Gumijasti srednji del ne sme biti med krivljenjem stisnjen ali poškodovan. Zato je treba uporabiti aluminijški pločevinski trak 2 do 5 mm (debeline) ukrivljen tako, da se lahko pritrdi kot zaščita na čeljusti. Tako dosežete večji polmer krivljenja in preprečite poškodovanje gumijastega srednjega dela.



## ALUMINIJ MREŽA ZA LOVLJENJE NESNAGE

P-PZNLN

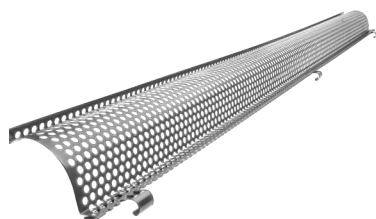



Nominalna velikost	333	
Dolžina v m	2,0	
Cena v €/kos	Brez DDV	Z DDV
<b>TM</b> 1 Testa di Moro RAL 8028	26,50	<b>32,33</b>
	064943	
<b>AN</b> 2 Antracit RAL 7016	26,50	<b>32,33</b>
	064912	
<b>IC</b> 3 Črna intenzivno RAL 9005	26,50	<b>32,33</b>
	064929 *	
<b>OC</b> 4 Vinsko rdeča RAL 3009	26,50	<b>32,33</b>
	064936 *	
<b>MH</b> 5 Opečno rdeča RAL 8004	26,50	<b>32,33</b>
	119766 *	
<b>SB</b> 6 Umazano bela RAL 9002	26,50	<b>32,33</b>
	117762 *	
<b>BH</b> 7 Srebrna RAL 9006	26,50	<b>32,33</b>
	117717 *	
<b>PS</b> 8 Prašno siva RAL 7037	26,50	<b>32,33</b>
	117755 *	
<b>MM</b> 9 Metalik bakrena RAL extra	26,50	<b>32,33</b>
	117724 *	
<b>BHT – P.20</b> 10 Temno srebrna RAL 9007	26,50	<b>32,33</b>
	097156 *	
<b>MZ</b> 11 Zelena mahovo RAL 6005	26,50	<b>32,33</b>
	117748 *	
<b>MOT</b> 12 Temno modra RAL 5010	26,50	<b>32,33</b>
	117731 *	
<b>TZ</b> 13 Zelena svetlo RAL 6011	26,50	<b>32,33</b>
	117779 *	
<b>Pakiranje v kos</b>	<b>15</b>	
<b>Pakiranje v kos</b>	<b>120</b>	

\* Izdelava po meri

# POCINKANO POLYESTER



## PVC MREŽA ZA LOVLJENJE LISTJA

## SD-ZNL MREZKA

Nominalna velikost	Dolžina v m	EAN številko izdelka	Pakiranje v kos		Cena [€/kos]	
					Brez DDV	Z DDV
<b>PS 171</b>	1,0	008473	30	450	4,50	<b>5,49</b>
<b>TM 171</b>	1,0	008466	30	450	4,50	<b>5,49</b>

## PVC MREŽA ZA LOVLJENJE LISTJA

## SD-ZNL N

Nominalna velikost	Dolžina v m	EAN številko izdelka	Pakiranje v kos		Cena [€/kos]	
					Brez DDV	Z DDV
<b>250</b>	3,0	008480	10	400	23,90	<b>29,16</b>
<b>280-333</b>	3,0	008497	10	400	24,00	<b>29,28</b>

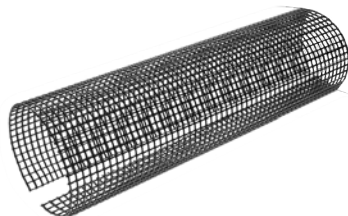
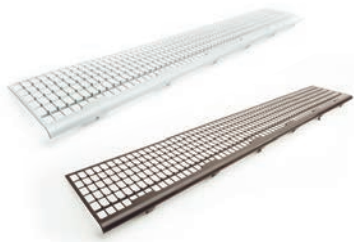

## STREŠNO DRŽALO ŽLEBA

## P-PDZNV



Nominalna velikost	250-280		333		400	
	18		20		22	
Velikost v mm						
Cena v €/kos	Brez DDV	Z DDV	Brez DDV	Z DDV	Brez DDV	Z DDV
<b>TM</b> 1 Testa di Moro RAL 8028	1,60	<b>1,95</b>	1,60	<b>1,95</b>	1,60	<b>1,95</b>
	085665		085672		085689 *	
<b>AN</b> 2 Antracit RAL 7016	1,60	<b>1,95</b>	1,60	<b>1,95</b>	1,60	<b>1,95</b>
	085290		085306		085313	
<b>IC</b> 3 Črna intenzivno RAL 9005	1,60	<b>1,95</b>	1,60	<b>1,95</b>	1,60	<b>1,95</b>
	085351		085368		085375 *	
<b>OC</b> 4 Vinsko rdeča RAL 3009	1,60	<b>1,95</b>	1,60	<b>1,95</b>	1,60	<b>1,95</b>
	085504		085573		085597 *	
<b>MH</b> 5 Opečno rdeča RAL 8004	1,60	<b>1,95</b>	1,60	<b>1,95</b>	1,60	<b>1,95</b>
	085382		085399		085405 *	
<b>SB</b> 6 Umazano bela RAL 9002	1,60	<b>1,95</b>	1,60	<b>1,95</b>	1,60	<b>1,95</b>
	085634 *		085641		085658 *	
<b>BH</b> 7 Srebrna RAL 9006	1,60	<b>1,95</b>	1,60	<b>1,95</b>	1,60	<b>1,95</b>
	085320		085337		085344 *	
<b>PS</b> 8 Prašno siva RAL 7037	1,60	<b>1,95</b>	1,60	<b>1,95</b>	1,60	<b>1,95</b>
	085603		085610		085627 *	
<b>MM</b> 9 Metalik bakrena RAL extra	1,60	<b>1,95</b>	1,60	<b>1,95</b>	1,60	<b>1,95</b>
	085412 *		085429		085436 *	
<b>BHT – P.20</b> 10 Temno srebrna RAL 9007	1,60	<b>1,95</b>	1,60	<b>1,95</b>	1,60	<b>1,95</b>
	094636 *		094643 *		094650 *	
<b>MZ</b> 11 Zelena mahovo RAL 6005	1,60	<b>1,95</b>	1,60	<b>1,95</b>	1,60	<b>1,95</b>
	085474 *		085481 *		085498 *	
<b>MOT</b> 12 Temno modra RAL 5010	1,60	<b>1,95</b>	1,60	<b>1,95</b>	1,60	<b>1,95</b>
	085443 *		085450 *		085467 *	
<b>TZ</b> 13 Zelena svetlo RAL 6011	1,60	<b>1,95</b>	1,60	<b>1,95</b>	1,60	<b>1,95</b>
	085696 *		085702 *		085719 *	
<b>Pakiranje v kos</b> 	<b>25</b>		<b>25</b>		<b>25</b>	
<b>Pakiranje v kos</b> 	<b>3 000</b>		<b>3 000</b>		<b>3 000</b>	

\* Izdelava po meri



## SPOJKA ŽLEBA

## P-PSPZ

Nominalna velikost	250		280		333	
	Brez DDV	Z DDV	Brez DDV	Z DDV	Brez DDV	Z DDV
<b>TM</b> 1 Testa di Moro RAL 8028	3,80	<b>4,64</b>	3,80	<b>4,64</b>	4,00	<b>4,88</b>
	083852		083869		083876	
<b>AN</b> 2 Antracit RAL 7016	3,80	<b>4,64</b>	3,80	<b>4,64</b>	4,00	<b>4,88</b>
	083456		083463		083470	
<b>IC</b> 3 Črna intenzivno RAL 9005	3,80	<b>4,64</b>	3,80	<b>4,64</b>	4,00	<b>4,88</b>
	083531		083548		083555	
<b>OC</b> 4 Vinsko rdeča RAL 3009	3,80	<b>4,64</b>	3,80	<b>4,64</b>	4,00	<b>4,88</b>
	083739		083746		083753	
<b>MH</b> 5 Opečno rdeča RAL 8004	3,80	<b>4,64</b>	3,80	<b>4,64</b>	4,00	<b>4,88</b>
	083579		083586		083593	
<b>SB</b> 6 Umazano bela RAL 9002	3,80	<b>4,64</b>	3,80	<b>4,64</b>	4,00	<b>4,88</b>
	083814		083821		083838	
<b>BH</b> 7 Srebrna RAL 9006	3,80	<b>4,64</b>	3,80	<b>4,64</b>	4,00	<b>4,88</b>
	083494		083500		083517	
<b>PS</b> 8 Prašno siva RAL 7037	3,80	<b>4,64</b>	3,80	<b>4,64</b>	4,00	<b>4,88</b>
	083777		083784		083791	
<b>MM</b> 9 Metalik bakrena RAL extra	3,80	<b>4,64</b>	3,80	<b>4,64</b>	4,00	<b>4,88</b>
	083616		083623		083630	
<b>BHT – P.20</b> 10 Temno srebrna RAL 9007	3,80	<b>4,64</b>	3,80	<b>4,64</b>	4,00	<b>4,88</b>
	094681		094698 *		094704	
<b>MZ</b> 11 Zelena mahovo RAL 6005	3,80	<b>4,64</b>	3,80	<b>4,64</b>	4,00	<b>4,88</b>
	083692		083708		083715	
<b>MOT</b> 12 Temno modra RAL 5010	3,80	<b>4,64</b>	3,80	<b>4,64</b>	4,00	<b>4,88</b>
	083654		083661		083678	
<b>TZ</b> 13 Zelena svetlo RAL 6011	3,80	<b>4,64</b>	3,80	<b>4,64</b>	4,00	<b>4,88</b>
	083890 *		083906 *		083913	
<b>Pakiranje v kos</b> 	<b>5</b>		<b>5</b>		<b>5</b>	
<b>Pakiranje v kos</b> 	<b>600</b>		<b>600</b>		<b>600</b>	

\* Izdelava po meri

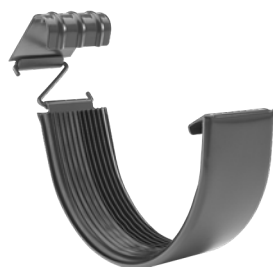

## KLJUKA

## P-PHP

Nominalna velikost	200/380		250/430		280/480		280/480	
Material	25/4		25/5		25/5		30/5	
Cena v €/kos	Brez DDV	Z DDV	Brez DDV	Z DDV	Brez DDV	Z DDV	Brez DDV	Z DDV
<b>TM</b> Testa di Moro RAL 8028	3,30	<b>4,03</b>	2,95	<b>3,60</b>	3,15	<b>3,84</b>	3,45	<b>4,21</b>
	045362		045379		045386		045393	
<b>AN</b> Antracit RAL 7016	3,30	<b>4,03</b>	2,95	<b>3,60</b>	3,15	<b>3,84</b>	3,45	<b>4,21</b>
	044648		044655		044662		044679	
<b>IC</b> Črna intenzivno RAL 9005	3,30	<b>4,03</b>	2,95	<b>3,60</b>	3,15	<b>3,84</b>	3,45	<b>4,21</b>
	044808		044815		044822		044839	
<b>OC</b> Vinsko rdeča RAL 3009	3,30	<b>4,03</b>	2,95	<b>3,60</b>	3,15	<b>3,84</b>	3,45	<b>4,21</b>
	045140		045157		045164		045171	
<b>MH</b> Opečno rdeča RAL 8004	3,30	<b>4,03</b>	2,95	<b>3,60</b>	3,15	<b>3,84</b>	3,45	<b>4,21</b>
	044884		044891		044907		044914	
<b>SB</b> Umazano bela RAL 9002	3,30	<b>4,03</b>	2,95	<b>3,60</b>	3,15	<b>3,84</b>	3,45	<b>4,21</b>
	045287		045294		045300		045317	
<b>BH</b> Srebrna RAL 9006	3,30	<b>4,03</b>	2,95	<b>3,60</b>	3,15	<b>3,84</b>	3,45	<b>4,21</b>
	044723		044730		044747		044754	
<b>PS</b> Prašno siva RAL 7037	3,30	<b>4,03</b>	2,95	<b>3,60</b>			3,45	<b>4,21</b>
	045225		045232				045249	
<b>MM</b> Metalik bakrena RAL extra	3,30	<b>4,03</b>	2,95	<b>3,60</b>			3,45	<b>4,21</b>
	044969		044976				044983	
<b>BHT – P.20</b> Temno srebrna RAL 9007			2,95	<b>3,60</b>			3,45	<b>4,21</b>
			095961				095978	
<b>MZ</b> Zelena mahovo RAL 6005	3,30	<b>4,03</b>	2,95	<b>3,60</b>			3,45	<b>4,21</b>
	045089		045096				045102	
<b>MOT</b> Temno modra RAL 5010	3,30	<b>4,03</b>	2,95	<b>3,60</b>			3,45	<b>4,21</b>
	045027		045034				045041	
<b>TZ</b> Zelena svetlo RAL 6011	3,30	<b>4,03</b>	2,95	<b>3,60</b>			3,45	<b>4,21</b>
	045454 *		045461				045478	
<b>Pakiranje v kos</b> 	<b>25</b>		<b>25</b>		<b>25</b>		<b>25</b>	
<b>Pakiranje v kos</b> 	<b>1 000</b>		<b>1 000</b>		<b>1 000</b>		<b>1 000</b>	

\* Izdelava po meri



## KLJUKA

## P-PHP

Nominalna velikost	333/550		333/550		333/550		333/610		400/610		
Material	25/5		30/4		30/5		30/5		30/6		
Cena v €/kos	Brez DDV	Z DDV	Brez DDV	Z DDV	Brez DDV	Z DDV	Brez DDV	Z DDV	Brez DDV	Z DDV	
<b>TM</b> Testa di Moro RAL 8028	1	3,15	<b>3,84</b>	3,30	<b>4,03</b>	3,50	<b>4,27</b>	4,10	<b>5,00</b>	5,90	<b>7,20</b>
		045409		045416 *		045423		045430		045447	
<b>AN</b> Antracit RAL 7016	2	3,15	<b>3,84</b>	3,30	<b>4,03</b>	3,50	<b>4,27</b>	4,10	<b>5,00</b>	5,90	<b>7,20</b>
		044686		080127 *		044693		044709		044716	
<b>IC</b> Črna intenzivno RAL 9005	3	3,15	<b>3,84</b>			3,50	<b>4,27</b>	4,10	<b>5,00</b>	5,90	<b>7,20</b>
		044846				044853		044860		044877	
<b>OC</b> Vinsko rdeča RAL 3009	4	3,15	<b>3,84</b>			3,50	<b>4,27</b>	4,10	<b>5,00</b>	5,90	<b>7,20</b>
		045188				045195		045201		045218	
<b>MH</b> Opečno rdeča RAL 8004	5	3,15	<b>3,84</b>			3,50	<b>4,27</b>	4,10	<b>5,00</b>	5,90	<b>7,20</b>
		044921				044938		044945		044952	
<b>SB</b> Umazano bela RAL 9002	6	3,15	<b>3,84</b>			3,50	<b>4,27</b>	4,10	<b>5,00</b>	5,90	<b>7,20</b>
		045324				045331		045348		045355	
<b>BH</b> Srebna RAL 9006	7	3,15	<b>3,84</b>			3,50	<b>4,27</b>	4,10	<b>5,00</b>	5,90	<b>7,20</b>
		044761				044778		044785		044792	
<b>PS</b> Prašno siva RAL 7037	8					3,50	<b>4,27</b>	4,10	<b>5,00</b>	5,90	<b>7,20</b>
						045256		045263		045270	
<b>MM</b> Metalik bakrena RAL extra	9					3,50	<b>4,27</b>	4,10	<b>5,00</b>	5,90	<b>7,20</b>
						044990		045003		045010	
<b>BHT – P.20</b> Temno srebna RAL 9007	10					3,50	<b>4,27</b>			5,90	<b>7,20</b>
						095985				095992	
<b>MZ</b> Zelena mahovo RAL 6005	11					3,50	<b>4,27</b>	4,10	<b>5,00</b>	5,90	<b>7,20</b>
						045119		045126		045133	
<b>MOT</b> Temno modra RAL 5010	12					3,50	<b>4,27</b>	4,10	<b>5,00</b>	5,90	<b>7,20</b>
						045058		045065		045072	
<b>TZ</b> Zelena svetlo RAL 6011	13					3,50	<b>4,27</b>	4,10	<b>5,00</b>	5,90	<b>7,20</b>
						045485		045492		045508 *	
<b>Pakiranje v kos</b>		<b>25</b>		<b>25</b>		<b>25</b>		<b>25</b>		<b>25</b>	
<b>Pakiranje v kos</b>		<b>1 000</b>		<b>1 000</b>		<b>1 000</b>		<b>1 000</b>		<b>500</b>	



\* Izdelava po meri

POCINKANO  
POLYESTER



## KLJUKA Z NOSOM

P-PHPN

Nominalna velikost	250/430		280/480		333/550	
Material	25/5		25/5		25/5	
Cena v €/kos	Brez DDV	Z DDV	Brez DDV	Z DDV	Brez DDV	Z DDV
<b>TM</b> 1 Testa di Moro RAL 8028	2,90	<b>3,54</b>	2,90	<b>3,54</b>	3,20	<b>3,90</b>
	095930		095947		095954	
<b>AN</b> 2 Antracit RAL 7016	2,90	<b>3,54</b>	2,90	<b>3,54</b>	3,20	<b>3,90</b>
	095824		095831		095848	
<b>IC</b> 3 Črna intenzivno RAL 9005			2,90	<b>3,54</b>	3,20	<b>3,90</b>
			095879		095886 *	
<b>MH</b> 5 Opečno rdeča RAL 8004			2,90	<b>3,54</b>	3,20	<b>3,90</b>
			095893		095909	
<b>SB</b> 6 Umazano bela RAL 9002			2,90	<b>3,54</b>	3,20	<b>3,90</b>
			095916		095923 *	
<b>BH</b> 7 Srebna RAL 9006			2,90	<b>3,54</b>	3,20	<b>3,90</b>
			095855		095862	
<b>PS</b> 8 Prašno siva RAL 7037					3,20	<b>3,90</b>
					117496 *	
Pakiranje v kos 	25		25		25	
Pakiranje v kos 	1 000		1 000		1 000	

\* Izdelava po meri

## KLJUKA KRATKA Z DODATNIM NOSILCEM

P-PHPNK



Nominalna velikost	250		280		333	
Material	25/4		25/4		25/5	
Cena v €/kos	Brez DDV	Z DDV	Brez DDV	Z DDV	Brez DDV	Z DDV
<b>TM</b> 1 Testa di Moro RAL 8028	3,15	<b>3,84</b>	3,35	<b>4,09</b>	3,55	<b>4,33</b>
	095435		095442		095459	
<b>AN</b> 2 Antracit RAL 7016	3,15	<b>3,84</b>	3,35	<b>4,09</b>	3,55	<b>4,33</b>
	095312		095329		095336	
<b>IC</b> 3 Črna intenzivno RAL 9005	3,15	<b>3,84</b>	3,35	<b>4,09</b>	3,55	<b>4,33</b>
	095374		095381		095398	
<b>MH</b> 5 Opečno rdeča RAL 8004	3,15	<b>3,84</b>	3,35	<b>4,09</b>	3,55	<b>4,33</b>
	095404		095411		095428	
<b>BH</b> 7 Srebna RAL 9006	3,15	<b>3,84</b>	3,35	<b>4,09</b>	3,55	<b>4,33</b>
	095343 *		095350		095367	
Pakiranje v kos 	25		25		25	
Pakiranje v kos 	1 000		1 000		1 000	

\* Izdelava po meri



## KLJUKA ZA LEŽEČI ŽLEB

P-PHSSN

Nominalna velikost	4	
Material	20/6	
Cena v €/kos	Brez DDV	Z DDV
<b>TM</b> 1 Testa di Moro RAL 8028	8,60	<b>10,49</b>
	033567	
<b>AN</b> 2 Antracit RAL 7016	8,60	<b>10,49</b>
	033468	
<b>IC</b> 3 Črna intenzivno RAL 9005	8,60	<b>10,49</b>
	033482	
<b>OC</b> 4 Vinsko rdeča RAL 3009	8,60	<b>10,49</b>
	033536	
<b>MH</b> 5 Opečno rdeča RAL 8004	8,60	<b>10,49</b>
	033499	
<b>SB</b> 6 Umazano bela RAL 9002	8,60	<b>10,49</b>
	033550	
<b>BH</b> 7 Srebrna RAL 9006	8,60	<b>10,49</b>
	033475	
<b>PS</b> 8 Prašno siva RAL 7037	8,60	<b>10,49</b>
	033543	
<b>MM</b> 9 Metalik bakrena RAL extra	8,60	<b>10,49</b>
	033505	
<b>BHT – P.20</b> 10 Temno srebrna RAL 9007	8,60	<b>10,49</b>
	095510 *	
<b>MZ</b> 11 Zelena mahovo RAL 6005	8,60	<b>10,49</b>
	033529	
<b>MOT</b> 12 Temno modra RAL 5010	8,60	<b>10,49</b>
	033512 *	
<b>TZ</b> 13 Zelena svetlo RAL 6011	8,60	<b>10,49</b>
	033574	
<b>Pakiranje v kos</b> 	<b>25</b>	
<b>Pakiranje v kos</b> 	<b>1 000</b>	

\* Izdelava po meri

POCINKANO  
POLYESTER





## KLJUKA KRATKA Z NOSILCEM

## P-PHPK





Nominalna velikost	200		250		280		333		400	
Material	25/4		25/4		25/4		25/5		30/5	
Cena v €/kos	Brez DDV	Z DDV	Brez DDV	Z DDV	Brez DDV	Z DDV	Brez DDV	Z DDV	Brez DDV	Z DDV
<b>TM</b> Testa di Moro RAL 8028	3,60	<b>4,39</b>	3,40	<b>4,15</b>	3,65	<b>4,45</b>	3,95	<b>4,82</b>	5,50	<b>6,71</b>
	065551		065568		065575		065582		065599	
<b>AN</b> Antracit RAL 7016	3,60	<b>4,39</b>	3,40	<b>4,15</b>	3,65	<b>4,45</b>	3,95	<b>4,82</b>	5,50	<b>6,71</b>
	065056		065063		065070		065087		065094	
<b>IC</b> Črna intenzivno RAL 9005	3,60	<b>4,39</b>	3,40	<b>4,15</b>	3,65	<b>4,45</b>	3,95	<b>4,82</b>	5,50	<b>6,71</b>
	065155		065162		065179		065186		065193 *	
<b>OC</b> Vinsko rdeča RAL 3009	3,60	<b>4,39</b>	3,40	<b>4,15</b>	3,65	<b>4,45</b>	3,95	<b>4,82</b>	5,50	<b>6,71</b>
	065407		065414		065421		065438		065445	
<b>MH</b> Opečno rdeča RAL 8004	3,60	<b>4,39</b>	3,40	<b>4,15</b>	3,65	<b>4,45</b>	3,95	<b>4,82</b>	5,50	<b>6,71</b>
	065209		065216		065223		065230		065247 *	
<b>SB</b> Umazano bela RAL 9002	3,60	<b>4,39</b>	3,40	<b>4,15</b>	3,65	<b>4,45</b>	3,95	<b>4,82</b>	5,50	<b>6,71</b>
	065506		065513		065520		065537		065544	
<b>BH</b> Srebrna RAL 9006	3,60	<b>4,39</b>	3,40	<b>4,15</b>	3,65	<b>4,45</b>	3,95	<b>4,82</b>	5,50	<b>6,71</b>
	065100		065117		065124		065131		065148	
<b>PS</b> Prašno siva RAL 7037	3,60	<b>4,39</b>	3,40	<b>4,15</b>	3,65	<b>4,45</b>	3,95	<b>4,82</b>	5,50	<b>6,71</b>
	065452		065469		065476		065483		065490	
<b>MM</b> Metalik bakrena RAL extra	3,60	<b>4,39</b>	3,40	<b>4,15</b>	3,65	<b>4,45</b>	3,95	<b>4,82</b>	5,50	<b>6,71</b>
	065254		065261		065278		065285		065292 *	
<b>BHT – P.20</b> Temno srebrna RAL 9007			3,40	<b>4,15</b>	3,65	<b>4,45</b>	3,95	<b>4,82</b>		
			095251		095268		095275			
<b>MZ</b> Zelena mahovo RAL 6005	3,60	<b>4,39</b>	3,40	<b>4,15</b>	3,65	<b>4,45</b>	3,95	<b>4,82</b>	5,50	<b>6,71</b>
	065353		065360		065377		065384		065391 *	
<b>MOT</b> Temno modra RAL 5010	3,60	<b>4,39</b>	3,40	<b>4,15</b>	3,65	<b>4,45</b>	3,95	<b>4,82</b>	5,50	<b>6,71</b>
	065308 *		065315		065322		065339		065346	
<b>TZ</b> Zelena svetlo RAL 6011	3,60	<b>4,39</b>	3,40	<b>4,15</b>	3,65	<b>4,45</b>	3,95	<b>4,82</b>	5,50	<b>6,71</b>
	065605 *		065612 *		065629 *		065636 *		065643 *	
Pakiranje v kos	25		25		25		25		20	
Pakiranje v kos	1 000		1 000		1 000		1 000		800	

\* Izdelava po meri

## VOGALNIK NOTRANJI

P-PRA

Nominalna velikost	200		250		280		333		400	
	Brez DDV	Z DDV	Brez DDV	Z DDV	Brez DDV	Z DDV	Brez DDV	Z DDV	Brez DDV	Z DDV
<b>TM</b> 1 Testa di Moro RAL 8028	11,90	<b>14,52</b>	11,70	<b>14,27</b>	11,80	<b>14,40</b>	11,90	<b>14,52</b>	29,90	<b>36,48</b>
	075673		075680		075697		075703		075710	
<b>AN</b> 2 Antracit RAL 7016	11,90	<b>14,52</b>	11,70	<b>14,27</b>	11,80	<b>14,40</b>	11,90	<b>14,52</b>	29,90	<b>36,48</b>
	075178		075185		075192		075208		075215	
<b>IC</b> 3 Črna intenzivno RAL 9005	11,90	<b>14,52</b>	11,70	<b>14,27</b>	11,80	<b>14,40</b>	11,90	<b>14,52</b>	29,90	<b>36,48</b>
	075260		075284		075291		075307		075314	
<b>OC</b> 4 Vinsko rdeča RAL 3009	11,90	<b>14,52</b>	11,70	<b>14,27</b>	11,80	<b>14,40</b>	11,90	<b>14,52</b>	29,90	<b>36,48</b>
	075529		075536		075543		075567		075550	
<b>MH</b> 5 Opečno rdeča RAL 8004	11,90	<b>14,52</b>	11,70	<b>14,27</b>	11,80	<b>14,40</b>	11,90	<b>14,52</b>	29,90	<b>36,48</b>
	075321		075338		075345		075352		075369	
<b>SB</b> 6 Umazano bela RAL 9002	11,90	<b>14,52</b>	11,70	<b>14,27</b>	11,80	<b>14,40</b>	11,90	<b>14,52</b>	29,90	<b>36,48</b>
	075635		075628		075642		075659		075666	
<b>BH</b> 7 Srebrna RAL 9006	11,90	<b>14,52</b>	11,70	<b>14,27</b>	11,80	<b>14,40</b>	11,90	<b>14,52</b>	29,90	<b>36,48</b>
	075222		075239		075246		075253		075277	
<b>PS</b> 8 Prašno siva RAL 7037	11,90	<b>14,52</b>	11,70	<b>14,27</b>	11,80	<b>14,40</b>	11,90	<b>14,52</b>	29,90	<b>36,48</b>
	075574		075581		075598		075604		075611	
<b>MM</b> 9 Metalik bakrena RAL extra	11,90	<b>14,52</b>	11,70	<b>14,27</b>	11,80	<b>14,40</b>	11,90	<b>14,52</b>	29,90	<b>36,48</b>
	075376		075383		075390		075406		075413	
<b>BHT – P.20</b> 10 Temno srebrna RAL 9007			11,70	<b>14,27</b>	11,80	<b>14,40</b>	11,90	<b>14,52</b>	29,90	<b>36,48</b>
			094384		094391 *		094407		110695	
<b>MZ</b> 11 Zelena mahovo RAL 6005	11,90	<b>14,52</b>	11,70	<b>14,27</b>	11,80	<b>14,40</b>	11,90	<b>14,52</b>	29,90	<b>36,48</b>
	075475		075482		075499		075505		075512	
<b>MOT</b> 12 Temno modra RAL 5010	11,90	<b>14,52</b>	11,70	<b>14,27</b>	11,80	<b>14,40</b>	11,90	<b>14,52</b>	29,90	<b>36,48</b>
	075420		075437		075444		075451		075468	
<b>TZ</b> 13 Zelena svetlo RAL 6011	11,90	<b>14,52</b>	11,70	<b>14,27</b>	11,80	<b>14,40</b>	11,90	<b>14,52</b>	29,90	<b>36,48</b>
	075727 *		075734		075741		075758		075765 *	
<b>Pakiranje v kos</b> 	<b>5</b>		<b>5</b>		<b>5</b>		<b>5</b>		<b>5</b>	
<b>Pakiranje v kos</b> 	<b>150</b>		<b>150</b>		<b>150</b>		<b>150</b>		<b>150</b>	



\* Izdelava po meri

POCINKANO  
POLYESTER



## VOGALNIK ZUNANJI

P-PRI



Nominalna velikost	200		250		280		333		400	
	Brez DDV	Z DDV	Brez DDV	Z DDV	Brez DDV	Z DDV	Brez DDV	Z DDV	Brez DDV	Z DDV
<b>TM</b> 1 Testa di Moro RAL 8028	11,90	<b>14,52</b>	11,70	<b>14,27</b>	11,80	<b>14,40</b>	11,90	<b>14,52</b>	29,90	<b>36,48</b>
	076281		076274		076298		076304		076311	
<b>AN</b> 2 Antracit RAL 7016	11,90	<b>14,52</b>	11,70	<b>14,27</b>	11,80	<b>14,40</b>	11,90	<b>14,52</b>	29,90	<b>36,48</b>
	075772		075789		075796		075802		075819	
<b>IC</b> 3 Črna intenzivno RAL 9005	11,90	<b>14,52</b>	11,70	<b>14,27</b>	11,80	<b>14,40</b>	11,90	<b>14,52</b>	29,90	<b>36,48</b>
	075871		075888		075895		075901		075918	
<b>OC</b> 4 Vinsko rdeča RAL 3009	11,90	<b>14,52</b>	11,70	<b>14,27</b>	11,80	<b>14,40</b>	11,90	<b>14,52</b>	29,90	<b>36,48</b>
	076120		076137		076144		076168		076151	
<b>MH</b> 5 Opečno rdeča RAL 8004	11,90	<b>14,52</b>	11,70	<b>14,27</b>	11,80	<b>14,40</b>	11,90	<b>14,52</b>	29,90	<b>36,48</b>
	075925		075932		075949		075956		075963	
<b>SB</b> 6 Umazano bela RAL 9002	11,90	<b>14,52</b>	11,70	<b>14,27</b>	11,80	<b>14,40</b>	11,90	<b>14,52</b>	29,90	<b>36,48</b>
	076229		076236		076243		076250		076267	
<b>BH</b> 7 Srebrna RAL 9006	11,90	<b>14,52</b>	11,70	<b>14,27</b>	11,80	<b>14,40</b>	11,90	<b>14,52</b>	29,90	<b>36,48</b>
	075826		075833		075840		075857		075864	
<b>PS</b> 8 Prašno siva RAL 7037	11,90	<b>14,52</b>	11,70	<b>14,27</b>	11,80	<b>14,40</b>	11,90	<b>14,52</b>	29,90	<b>36,48</b>
	076175		076199		076182		076205		076212	
<b>MM</b> 9 Metalik bakrena RAL extra	11,90	<b>14,52</b>	11,70	<b>14,27</b>	11,80	<b>14,40</b>	11,90	<b>14,52</b>	29,90	<b>36,48</b>
	075970		075987		075994		076007		076014	
<b>BHT – P.20</b> 10 Temno srebrna RAL 9007			11,70	<b>14,27</b>	11,80	<b>14,40</b>	11,90	<b>14,52</b>	29,90	<b>36,48</b>
			094414		094421 *		094438		110688	
<b>MZ</b> 11 Zelena mahovo RAL 6005	11,90	<b>14,52</b>	11,70	<b>14,27</b>	11,80	<b>14,40</b>	11,90	<b>14,52</b>	29,90	<b>36,48</b>
	076076		076083		076090		076106		076113	
<b>MOT</b> 12 Temno modra RAL 5010	11,90	<b>14,52</b>	11,70	<b>14,27</b>	11,80	<b>14,40</b>	11,90	<b>14,52</b>	29,90	<b>36,48</b>
	076021 *		076038		076045		076052		076069	
<b>TZ</b> 13 Zelena svetlo RAL 6011	11,90	<b>14,52</b>	11,70	<b>14,27</b>	11,80	<b>14,40</b>	11,90	<b>14,52</b>	29,90	<b>36,48</b>
	076335 *		076328		076342		076359		076366 *	
<b>Pakiranje v kos</b> 	<b>5</b>		<b>5</b>		<b>5</b>		<b>5</b>		<b>5</b>	
<b>Pakiranje v kos</b> 	<b>150</b>		<b>150</b>		<b>150</b>		<b>150</b>		<b>150</b>	

\* Izdelava po meri



## ZAKLJUČEK ŽLEBA

P-PCL



Nominalna velikost	200		250		280		333		400	
	Brez DDV	Z DDV	Brez DDV	Z DDV	Brez DDV	Z DDV	Brez DDV	Z DDV	Brez DDV	Z DDV
<b>TM</b> 1 Testa di Moro RAL 8028	1,45	1,77	1,30	1,59	1,40	1,71	1,45	1,77	2,25	2,75
	003164		003171		003188		003195		003201	
<b>AN</b> 2 Antracit RAL 7016	1,45	1,77	1,30	1,59	1,40	1,71	1,45	1,77	2,25	2,75
	002662		002679		002686		002693		002709	
<b>IC</b> 3 Črna intenzivno RAL 9005	1,45	1,77	1,30	1,59	1,40	1,71	1,45	1,77	2,25	2,75
	002761		002778		002785		002792		002808	
<b>OC</b> 4 Vinsko rdeča RAL 3009	1,45	1,77	1,30	1,59	1,40	1,71	1,45	1,77	2,25	2,75
	003010		003027		003034		003041		003058	
<b>MH</b> 5 Opečno rdeča RAL 8004	1,45	1,77	1,30	1,59	1,40	1,71	1,45	1,77	2,25	2,75
	002815		002822		002839		002846		002853	
<b>SB</b> 6 Umazano bela RAL 9002	1,45	1,77	1,30	1,59	1,40	1,71	1,45	1,77	2,25	2,75
	003119		003126		003133		003140		003157	
<b>BH</b> 7 Srebrna RAL 9006	1,45	1,77	1,30	1,59	1,40	1,71	1,45	1,77	2,25	2,75
	002716		002723		002730		002747		002754	
<b>PS</b> 8 Prašno siva RAL 7037	1,45	1,77	1,30	1,59	1,40	1,71	1,45	1,77	2,25	2,75
	003065		003072		003089		003096		003102	
<b>MM</b> 9 Metalik bakrena RAL extra	1,45	1,77	1,30	1,59	1,40	1,71	1,45	1,77	2,25	2,75
	002860		002877		002884		002891		002907	
<b>BHT – P.20</b> 10 Temno srebrna RAL 9007			1,30	1,59	1,40	1,71	1,45	1,77	2,25	2,75
			094568		094575 *		094582		094599	
<b>MZ</b> 11 Zelena mahovo RAL 6005	1,45	1,77	1,30	1,59	1,40	1,71	1,45	1,77	2,25	2,75
	002969		002976		002983		002990		003003	
<b>MOT</b> 12 Temno modra RAL 5010	1,45	1,77	1,30	1,59	1,40	1,71	1,45	1,77	2,25	2,75
	002914		002921		002938		002945		002952	
<b>TZ</b> 13 Zelena svetlo RAL 6011	1,45	1,77	1,30	1,59	1,40	1,71	1,45	1,77	2,25	2,75
	003218 *		003225		003232		003249		003256	
<b>Pakiranje v kos</b> 	<b>6/60</b>		<b>6/60</b>		<b>6/60</b>		<b>6/60</b>		<b>4/40</b>	
<b>Pakiranje v kos</b> 	<b>1 440</b>		<b>1 440</b>		<b>1 440</b>		<b>1 440</b>		<b>960</b>	

\* Izdelava po meri



## ZAKLJUČEK Z GUMO

## P-PCLG



Nominalna velikost	250		280		333	
	Brez DDV	Z DDV	Brez DDV	Z DDV	Brez DDV	Z DDV
<b>TM</b> 1 Testa di Moro RAL 8028	2,65	<b>3,23</b>	2,90	<b>3,54</b>	3,00	<b>3,66</b>
	004338		004345		004352	
<b>AN</b> 2 Antracit RAL 7016	2,65	<b>3,23</b>	2,90	<b>3,54</b>	3,00	<b>3,66</b>
	004031		004048		004055	
<b>IC</b> 3 Črna intenzivno RAL 9005	2,65	<b>3,23</b>	2,90	<b>3,54</b>	3,00	<b>3,66</b>
	004093		004109		004116	
<b>OC</b> 4 Vinsko rdeča RAL 3009	2,65	<b>3,23</b>	2,90	<b>3,54</b>	3,00	<b>3,66</b>
	004246		004253		004260	
<b>MH</b> 5 Opečno rdeča RAL 8004	2,65	<b>3,23</b>	2,90	<b>3,54</b>	3,00	<b>3,66</b>
	004123		004130		004147	
<b>SB</b> 6 Umazano bela RAL 9002	2,65	<b>3,23</b>	2,90	<b>3,54</b>	3,00	<b>3,66</b>
	004307		004314		004321	
<b>BH</b> 7 Srebrna RAL 9006	2,65	<b>3,23</b>	2,90	<b>3,54</b>	3,00	<b>3,66</b>
	004062		004079		004086	
<b>PS</b> 8 Prašno siva RAL 7037	2,65	<b>3,23</b>	2,90	<b>3,54</b>	3,00	<b>3,66</b>
	004277		004284		004291	
<b>MM</b> 9 Metalik bakrena RAL extra	2,65	<b>3,23</b>	2,90	<b>3,54</b>	3,00	<b>3,66</b>
	004154		004161		004178	
<b>BHT – P.20</b> 10 Temno srebrna RAL 9007	2,65	<b>3,23</b>	2,90	<b>3,54</b>	3,00	<b>3,66</b>
	094605		094612 *		094629	
<b>MZ</b> 11 Zelena mahovo RAL 6005	2,65	<b>3,23</b>	2,90	<b>3,54</b>	3,00	<b>3,66</b>
	004215		004222		004239	
<b>MOT</b> 12 Temno modra RAL 5010	2,65	<b>3,23</b>	2,90	<b>3,54</b>	3,00	<b>3,66</b>
	004185		004192		004208	
<b>TZ</b> 13 Zelena svetlo RAL 6011	2,65	<b>3,23</b>	2,90	<b>3,54</b>	3,00	<b>3,66</b>
	004369 *		004376 *		004383 *	
<b>Pakiranje v kos</b> 	<b>4/40</b>		<b>4/40</b>		<b>4/40</b>	
<b>Pakiranje v kos</b> 	<b>960</b>		<b>960</b>		<b>960</b>	

\* Izdelava po meri



## KOTLIČEK

## P-PKL

Nominalna velikost	200/60		250/60		250/80		280/80		280/100	
	Brez DDV	Z DDV	Brez DDV	Z DDV	Brez DDV	Z DDV	Brez DDV	Z DDV	Brez DDV	Z DDV
<b>TM</b> 1 Testa di Moro RAL 8028	7,40	<b>9,03</b>	9,00	<b>10,98</b>	6,60	<b>8,05</b>	7,20	<b>8,78</b>	7,20	<b>8,78</b>
	067357		067364		067371		067388		067395	
<b>AN</b> 2 Antracit RAL 7016	7,40	<b>9,03</b>	9,00	<b>10,98</b>	6,60	<b>8,05</b>	7,20	<b>8,78</b>	7,20	<b>8,78</b>
	066251		066268		066275		066282		066299	
<b>IC</b> 3 Črna intenzivno RAL 9005	7,40	<b>9,03</b>	9,00	<b>10,98</b>	6,60	<b>8,05</b>	7,20	<b>8,78</b>	7,20	<b>8,78</b>
	066473		066480		066497		066503		066510	
<b>OC</b> 4 Vinsko rdeča RAL 3009	7,40	<b>9,03</b>	9,00	<b>10,98</b>	6,60	<b>8,05</b>	7,20	<b>8,78</b>	7,20	<b>8,78</b>
	067029		067036		067043		067050		067067	
<b>MH</b> 5 Opečno rdeča RAL 8004	7,40	<b>9,03</b>	9,00	<b>10,98</b>	6,60	<b>8,05</b>	7,20	<b>8,78</b>	7,20	<b>8,78</b>
	066589		066596		066602		066619		066626	
<b>SB</b> 6 Umazano bela RAL 9002	7,40	<b>9,03</b>	9,00	<b>10,98</b>	6,60	<b>8,05</b>	7,20	<b>8,78</b>	7,20	<b>8,78</b>
	067241		067258		067265		067272		067289	
<b>BH</b> 7 Srebrna RAL 9006	7,40	<b>9,03</b>	9,00	<b>10,98</b>	6,60	<b>8,05</b>	7,20	<b>8,78</b>	7,20	<b>8,78</b>
	066367		066374		066381		066398		066404	
<b>PS</b> 8 Prašno siva RAL 7037	7,40	<b>9,03</b>	9,00	<b>10,98</b>	6,60	<b>8,05</b>	7,20	<b>8,78</b>	7,20	<b>8,78</b>
	067135		067142 *		067159		067166		067173	
<b>MM</b> 9 Metalik bakrena RAL extra	7,40	<b>9,03</b>	9,00	<b>10,98</b>	6,60	<b>8,05</b>	7,20	<b>8,78</b>	7,20	<b>8,78</b>
	066695		066701 *		066718		066725		066732	
<b>BHT – P.20</b> 10 Temno srebrna RAL 9007	7,40	<b>9,03</b>	9,00	<b>10,98</b>	6,60	<b>8,05</b>	7,20	<b>8,78</b>	7,20	<b>8,78</b>
	119728 *		119735 *		094469		094476		094483	
<b>MZ</b> 11 Zelena mahovo RAL 6005	7,40	<b>9,03</b>	9,00	<b>10,98</b>	6,60	<b>8,05</b>	7,20	<b>8,78</b>	7,20	<b>8,78</b>
	066916		066923		066930		066947		066954	
<b>MOT</b> 12 Temno modra RAL 5010	7,40	<b>9,03</b>	9,00	<b>10,98</b>	6,60	<b>8,05</b>	7,20	<b>8,78</b>	7,20	<b>8,78</b>
	066800 *		066817 *		066824		066831		066848	
<b>TZ</b> 13 Zelena svetlo RAL 6011	7,40	<b>9,03</b>	9,00	<b>10,98</b>	6,60	<b>8,05</b>	7,20	<b>8,78</b>	7,20	<b>8,78</b>
	067463 *		067470 *		067487		067494 *		067500	
<b>Pakiranje v kos</b> 	<b>20</b>		<b>20</b>		<b>20</b>		<b>20</b>		<b>20</b>	
<b>Pakiranje v kos</b> 	<b>600</b>		<b>600</b>		<b>600</b>		<b>600</b>		<b>600</b>	



\* Izdelava po meri



## KOTLIČEK

P-PKL



Nominalna velikost	333/80		333/100		333/120	
	Brez DDV	Z DDV	Brez DDV	Z DDV	Brez DDV	Z DDV
<b>TM</b> 1 Testa di Moro RAL 8028	8,40	<b>10,25</b>	7,95	<b>9,70</b>	9,50	<b>11,59</b>
	067401		067418		067425	
<b>AN</b> 2 Antracit RAL 7016	8,40	<b>10,25</b>	7,95	<b>9,70</b>	9,50	<b>11,59</b>
	066305		066312		066329	
<b>IC</b> 3 Črna intenzivno RAL 9005	8,40	<b>10,25</b>	7,95	<b>9,70</b>	9,50	<b>11,59</b>
	066527		066534		066541	
<b>OC</b> 4 Vinsko rdeča RAL 3009	8,40	<b>10,25</b>	7,95	<b>9,70</b>	9,50	<b>11,59</b>
	067074		067081		067098	
<b>MH</b> 5 Opečno rdeča RAL 8004	8,40	<b>10,25</b>	7,95	<b>9,70</b>	9,50	<b>11,59</b>
	066633		066640		066657	
<b>SB</b> 6 Umazano bela RAL 9002	8,40	<b>10,25</b>	7,95	<b>9,70</b>	9,50	<b>11,59</b>
	067296		067302		067326	
<b>BH</b> 7 Srebrna RAL 9006	8,40	<b>10,25</b>	7,95	<b>9,70</b>	9,50	<b>11,59</b>
	066411		066428		066435	
<b>PS</b> 8 Prašno siva RAL 7037	8,40	<b>10,25</b>	7,95	<b>9,70</b>	9,50	<b>11,59</b>
	067180		067197		067203	
<b>MM</b> 9 Metalik bakrena RAL extra	8,40	<b>10,25</b>	7,95	<b>9,70</b>	9,50	<b>11,59</b>
	066749		066756		066763	
<b>BHT – P.20</b> 10 Temno srebrna RAL 9007	8,40	<b>10,25</b>	7,95	<b>9,70</b>	9,50	<b>11,59</b>
	094490 *		094506		094513	
<b>MZ</b> 11 Zelena mahovo RAL 6005	8,40	<b>10,25</b>	7,95	<b>9,70</b>	9,50	<b>11,59</b>
	066961		066978		066985	
<b>MOT</b> 12 Temno modra RAL 5010	8,40	<b>10,25</b>	7,95	<b>9,70</b>	9,50	<b>11,59</b>
	066855 *		066862		066879	
<b>TZ</b> 13 Zelena svetlo RAL 6011	8,40	<b>10,25</b>	7,95	<b>9,70</b>	9,50	<b>11,59</b>
	067517 *		067524		067531	
<b>Pakiranje v kos</b> 	<b>20</b>		<b>20</b>		<b>15</b>	
<b>Pakiranje v kos</b> 	<b>600</b>		<b>600</b>		<b>300</b>	

\* Izdelava po meri

## KOTLIČEK

## P-PKL

Nominalna velikost	400/100		400/120		400/150	
	Brez DDV	Z DDV	Brez DDV	Z DDV	Brez DDV	Z DDV
<b>TM</b> 1 Testa di Moro RAL 8028	19,00	<b>23,18</b>	19,00	<b>23,18</b>	21,50	<b>26,23</b>
	067432		067449		067456	
<b>AN</b> 2 Antracit RAL 7016	19,00	<b>23,18</b>	19,00	<b>23,18</b>	21,50	<b>26,23</b>
	066336		066343		066350	
<b>IC</b> 3 Črna intenzivno RAL 9005	19,00	<b>23,18</b>	19,00	<b>23,18</b>	21,50	<b>26,23</b>
	066558		066565		066572	
<b>OC</b> 4 Vinsko rdeča RAL 3009	19,00	<b>23,18</b>	19,00	<b>23,18</b>	21,50	<b>26,23</b>
	067104 *		067111		067128	
<b>MH</b> 5 Opečno rdeča RAL 8004	19,00	<b>23,18</b>	19,00	<b>23,18</b>	21,50	<b>26,23</b>
	066664 *		066671		066688	
<b>SB</b> 6 Umazano bela RAL 9002	19,00	<b>23,18</b>	19,00	<b>23,18</b>	21,50	<b>26,23</b>
	067319		067333		067340	
<b>BH</b> 7 Srebrna RAL 9006	19,00	<b>23,18</b>	19,00	<b>23,18</b>	21,50	<b>26,23</b>
	066442		066459		066466	
<b>PS</b> 8 Prašno siva RAL 7037	19,00	<b>23,18</b>	19,00	<b>23,18</b>	21,50	<b>26,23</b>
	067210		067227		067234	
<b>MM</b> 9 Metalik bakrena RAL extra	19,00	<b>23,18</b>	19,00	<b>23,18</b>	21,50	<b>26,23</b>
	066770 *		066787 *		066794 *	
<b>BHT – P.20</b> 10 Temno srebrna RAL 9007	19,00	<b>23,18</b>	19,00	<b>23,18</b>	21,50	<b>26,23</b>
	119742 *		094520		094667	
<b>MZ</b> 11 Zelena mahovo RAL 6005	19,00	<b>23,18</b>	19,00	<b>23,18</b>	21,50	<b>26,23</b>
	066992 *		067005		067012	
<b>MOT</b> 12 Temno modra RAL 5010	19,00	<b>23,18</b>	19,00	<b>23,18</b>	21,50	<b>26,23</b>
	066886 *		066893		066909	
<b>TZ</b> 13 Zelena svetlo RAL 6011	19,00	<b>23,18</b>	19,00	<b>23,18</b>	21,50	<b>26,23</b>
	067548 *		067555		067562 *	
<b>Pakiranje v kos</b> 	<b>15</b>		<b>15</b>		<b>15</b>	
<b>Pakiranje v kos</b> 	<b>300</b>		<b>300</b>		<b>300</b>	

\* Izdelava po meri





NOV PRIČVRSTILNI  
SISTEM FEDER OMOGOČA  
LAHKO OBRAČANJE KOLENA  
DO ŽELJENE SMERI IN OSTANE  
FIKSIRANO V VSAKI POZICIJI.  
ENOSTAVNA MONTAŽA NA  
BILO KATERO KOLENO  
BREZ KOVIČENJA.

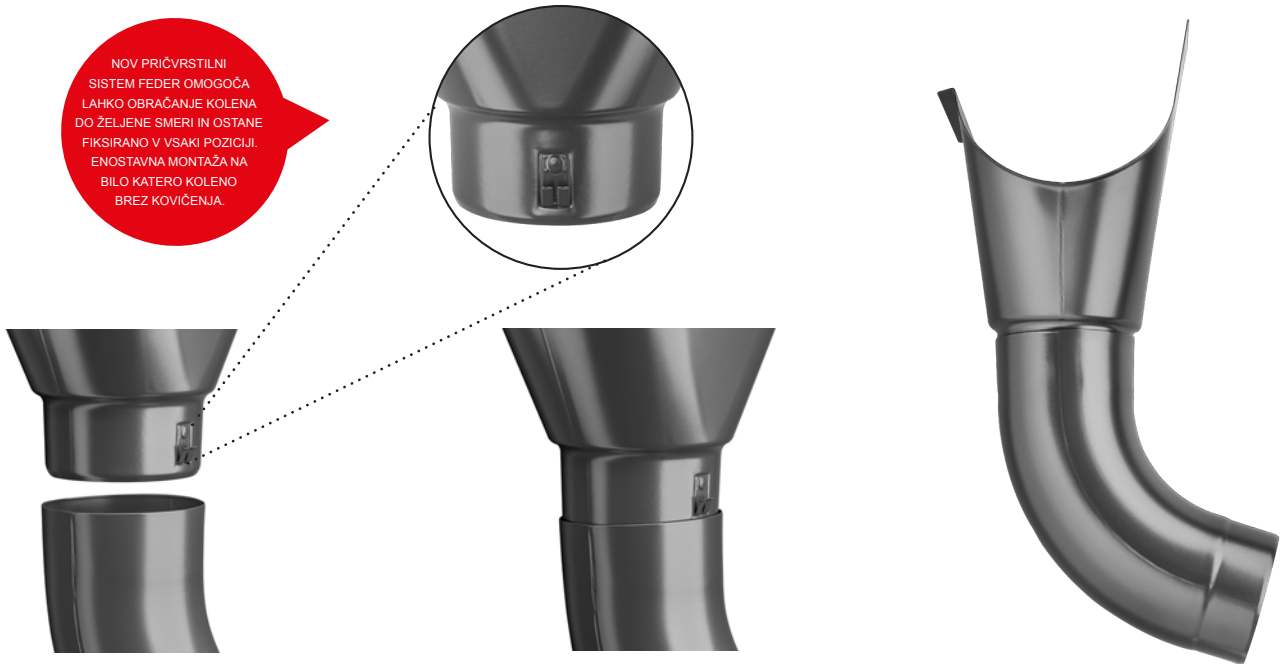

**POCINKANO**  
POLYESTER



## ZBIRNI KOTLIČEK CENTRALNI

## IT-KLZF C

Nominalna velikost	60		80		100		120	
Cena v €/kos	Brez DDV		Brez DDV		Brez DDV		Brez DDV	
<b>TM</b> 1 Testa di Moro RAL 8028	14,90	<b>18,18</b>	15,00	<b>18,30</b>	16,20	<b>19,76</b>	21,60	<b>26,35</b>
	077028 *		077042 *		077066 *		077080 *	
<b>AN</b> 2 Antracit RAL 7016	14,90	<b>18,18</b>	15,00	<b>18,30</b>	16,20	<b>19,76</b>	21,60	<b>26,35</b>
	076540 *		076564 *		076588 *		076601 *	
<b>IC</b> 3 Črna intenzivno RAL 9005	14,90	<b>18,18</b>	15,00	<b>18,30</b>	16,20	<b>19,76</b>	21,60	<b>26,35</b>
	076700 *		076724 *		076748 *		076762 *	
<b>OC</b> 4 Vinsko rdeča RAL 3009	14,90	<b>18,18</b>	15,00	<b>18,30</b>	16,20	<b>19,76</b>	21,60	<b>26,35</b>
	076861 *		076885 *		076908 *		076922 *	
<b>MH</b> 5 Opečno rdeča RAL 8004	14,90	<b>18,18</b>	15,00	<b>18,30</b>	16,20	<b>19,76</b>	21,60	<b>26,35</b>
	076786 *		076809 *		076823 *		076847 *	
<b>SB</b> 6 Umazano bela RAL 9002	14,90	<b>18,18</b>	15,00	<b>18,30</b>	16,20	<b>19,76</b>	21,60	<b>26,35</b>
	076946 *		076960 *		076984 *		077004 *	
<b>BH</b> 7 Srebrna RAL 9006	14,90	<b>18,18</b>	15,00	<b>18,30</b>	16,20	<b>19,76</b>	21,60	<b>26,35</b>
	076625 *		076649 *		076663 *		076687 *	
<b>PS</b> 8 Prašno siva RAL 7037								
<b>MM</b> 9 Metalik bakrena RAL extra								
<b>BHT – P.20</b> 10 Temno srebrna RAL 9007								
<b>MZ</b> 11 Zelena mahovo RAL 6005								
<b>MOT</b> 12 Temno modra RAL 5010								
<b>TZ</b> 13 Zelena svetlo RAL 6011								
<b>Pakiranje v kos</b> 	<b>10</b>		<b>10</b>		<b>10</b>		<b>10</b>	
<b>Pakiranje v kos</b> 	<b>300</b>		<b>300</b>		<b>200</b>		<b>200</b>	

\* Izdelava po meri



## ZBIRNI KOTLIČEK STRANSKI

## IT-KLZF B





Nominalna velikost	60		80		100		120	
	Brez DDV		Brez DDV		Brez DDV		Brez DDV	
<b>TM</b> 1 Testa di Moro RAL 8028	14,90	<b>18,18</b>	15,00	<b>18,30</b>	16,20	<b>19,76</b>	21,60	<b>26,35</b>
	077011 *		077035 *		077059 *		077073 *	
<b>AN</b> 2 Antracit RAL 7016	14,90	<b>18,18</b>	15,00	<b>18,30</b>	16,20	<b>19,76</b>	21,60	<b>26,35</b>
	076533 *		076557 *		076571 *		076595 *	
<b>IC</b> 3 Črna intenzivno RAL 9005	14,90	<b>18,18</b>	15,00	<b>18,30</b>	16,20	<b>19,76</b>	21,60	<b>26,35</b>
	076694 *		076717 *		076731 *		076755 *	
<b>OC</b> 4 Vinsko rdeča RAL 3009	14,90	<b>18,18</b>	15,00	<b>18,30</b>	16,20	<b>19,76</b>	21,60	<b>26,35</b>
	076854 *		076878 *		076892 *		076915 *	
<b>MH</b> 5 Opečno rdeča RAL 8004	14,90	<b>18,18</b>	15,00	<b>18,30</b>	16,20	<b>19,76</b>	21,60	<b>26,35</b>
	076779 *		076793 *		076816 *		076830 *	
<b>SB</b> 6 Umazano bela RAL 9002	14,90	<b>18,18</b>	15,00	<b>18,30</b>	16,20	<b>19,76</b>	21,60	<b>26,35</b>
	076939 *		076953 *		076977 *		076991 *	
<b>BH</b> 7 Srebrna RAL 9006	14,90	<b>18,18</b>	15,00	<b>18,30</b>	16,20	<b>19,76</b>	21,60	<b>26,35</b>
	076618 *		076632 *		076656 *		076670 *	
<b>PS</b> 8 Prašno siva RAL 7037								
<b>MM</b> 9 Metalik bakrena RAL extra								
<b>BHT – P.20</b> 10 Temno srebrna RAL 9007								
<b>MZ</b> 11 Zelena mahovo RAL 6005								
<b>MOT</b> 12 Temno modra RAL 5010								
<b>TZ</b> 13 Zelena svetlo RAL 6011								
<b>Pakiranje v kos</b>	<b>10</b>		<b>10</b>		<b>10</b>		<b>10</b>	
<b>Pakiranje v kos</b>	<b>300</b>		<b>300</b>		<b>200</b>		<b>200</b>	

\* Izdelava po meri

## GRLO ZA STREŠNI ŽLEB

P-PHRD

Nominalna velikost	80		100		120	
	Brez DDV	Z DDV	Brez DDV	Z DDV	Brez DDV	Z DDV
<b>TM</b> 1 Testa di Moro RAL 8028	1,65	<b>2,01</b>	1,75	<b>2,14</b>	2,10	<b>2,56</b>
	066015		066022		066039	
<b>AN</b> 2 Antracit RAL 7016	1,65	<b>2,01</b>	1,75	<b>2,14</b>	2,10	<b>2,56</b>
	065711		065728		065735 *	
<b>IC</b> 3 Črna intenzivno RAL 9005	1,65	<b>2,01</b>	1,75	<b>2,14</b>	2,10	<b>2,56</b>
	065773 *		065780		065797 *	
<b>OC</b> 4 Vinsko rdeča RAL 3009	1,65	<b>2,01</b>	1,75	<b>2,14</b>	2,10	<b>2,56</b>
	065926 *		065933		065940 *	
<b>MH</b> 5 Opečno rdeča RAL 8004	1,65	<b>2,01</b>	1,75	<b>2,14</b>	2,10	<b>2,56</b>
	065803 *		065810		065827 *	
<b>SB</b> 6 Umazano bela RAL 9002	1,65	<b>2,01</b>	1,75	<b>2,14</b>	2,10	<b>2,56</b>
	065988 *		065995 *		066008 *	
<b>BH</b> 7 Srebrna RAL 9006	1,65	<b>2,01</b>	1,75	<b>2,14</b>	2,10	<b>2,56</b>
	065742 *		065759 *		065766 *	
<b>PS</b> 8 Prašno siva RAL 7037	1,65	<b>2,01</b>	1,75	<b>2,14</b>	2,10	<b>2,56</b>
	065957 *		065964 *		065971 *	
<b>MM</b> 9 Metalik bakrena RAL extra	1,65	<b>2,01</b>	1,75	<b>2,14</b>	2,10	<b>2,56</b>
	065834 *		065841 *		065858 *	
<b>BHT – P.20</b> 10 Temno srebrna RAL 9007						
<b>MZ</b> 11 Zelena mahovo RAL 6005	1,65	<b>2,01</b>	1,75	<b>2,14</b>	2,10	<b>2,56</b>
	065896 *		065902 *		065919 *	
<b>MOT</b> 12 Temno modra RAL 5010	1,65	<b>2,01</b>	1,75	<b>2,14</b>	2,10	<b>2,56</b>
	065865 *		065872 *		065889 *	
<b>TZ</b> 13 Zelena svetlo RAL 6011	1,65	<b>2,01</b>	1,75	<b>2,14</b>	2,10	<b>2,56</b>
	066046 *		066053 *		066060 *	
<b>Pakiranje v kos</b> 	<b>25</b>		<b>25</b>		<b>15</b>	
<b>Pakiranje v kos</b> 	<b>1 000</b>		<b>1 000</b>		<b>750</b>	

\* Izdelava po meri





# POCINKANO POLYESTER

## INOX LOVILEC NESNAGE

N-NZN





Nominalna velikost	EAN številko izdelka	Pakiranje v kos		Cena [€/kos]	
				Brez DDV	Z DDV
<b>60</b>	001153	30	2 160	5,55	<b>6,77</b>
<b>80</b>	001160	20	1 440	5,60	<b>6,83</b>
<b>100</b>	001177	15	1 080	5,70	<b>6,95</b>
<b>120</b>	001184	10	720	6,20	<b>7,56</b>
<b>150</b>	001191	5	360	9,80	<b>11,96</b>



## ZBIRNI KOTLIČEK DESIGN

## P-PKLZ DE

Nominalna velikost	80		100		120	
	Brez DDV	Z DDV	Brez DDV	Z DDV	Brez DDV	Z DDV
<b>TM</b> 1 Testa di Moro RAL 8028	58,00	<b>70,76</b>	58,00	<b>70,76</b>	64,00	<b>78,08</b>
	027702		027726		027740	
<b>AN</b> 2 Antracit RAL 7016	58,00	<b>70,76</b>	58,00	<b>70,76</b>	64,00	<b>78,08</b>
	026200		026224		026248	
<b>IC</b> 3 Črna intenzivno RAL 9005	58,00	<b>70,76</b>	58,00	<b>70,76</b>	64,00	<b>78,08</b>
	026507		026521		026545	
<b>OC</b> 4 Vinsko rdeča RAL 3009	58,00	<b>70,76</b>	58,00	<b>70,76</b>	64,00	<b>78,08</b>
	027252 *		027276		027290	
<b>MH</b> 5 Opečno rdeča RAL 8004	58,00	<b>70,76</b>	58,00	<b>70,76</b>	64,00	<b>78,08</b>
	026651		026675		026699	
<b>SB</b> 6 Umazano bela RAL 9002	58,00	<b>70,76</b>	58,00	<b>70,76</b>	64,00	<b>78,08</b>
	027559 *		027573		027597	
<b>BH</b> 7 Srebrna RAL 9006	58,00	<b>70,76</b>	58,00	<b>70,76</b>	64,00	<b>78,08</b>
	026354		026378		026392	
<b>PS</b> 8 Prašno siva RAL 7037	58,00	<b>70,76</b>	58,00	<b>70,76</b>	64,00	<b>78,08</b>
	027405		027429		027443	
<b>MM</b> 9 Metalik bakrena RAL extra	58,00	<b>70,76</b>	58,00	<b>70,76</b>	64,00	<b>78,08</b>
	026804 *		026828		026842	
<b>BHT – P.20</b> 10 Temno srebrna RAL 9007	58,00	<b>70,76</b>	58,00	<b>70,76</b>	64,00	<b>78,08</b>
	096210		096265		096319	
<b>MZ</b> 11 Zelena mahovo RAL 6005	58,00	<b>70,76</b>	58,00	<b>70,76</b>	64,00	<b>78,08</b>
	027108 *		027122		027146 *	
<b>MOT</b> 12 Temno modra RAL 5010	58,00	<b>70,76</b>	58,00	<b>70,76</b>	64,00	<b>78,08</b>
	026958 *		026972		027009 *	
<b>TZ</b> 13 Zelena svetlo RAL 6011	58,00	<b>70,76</b>	58,00	<b>70,76</b>	64,00	<b>78,08</b>
	027856 *		027870 *		027894 *	
<b>Pakiranje v kos</b> 	<b>2</b>		<b>2</b>		<b>2</b>	
<b>Pakiranje v kos</b> 	<b>36</b>		<b>36</b>		<b>36</b>	

\* Izdelava po meri



## ZBIRNI KOTLIČEK DESIGN EKSCENTRIČE

## P-PKLZ DX



Nominalna velikost	80		100		120	
	Brez DDV	Z DDV	Brez DDV	Z DDV	Brez DDV	Z DDV
<b>TM</b> 1 Testa di Moro RAL 8028	72,00	<b>87,84</b>	72,00	<b>87,84</b>	74,00	<b>90,28</b>
	027764		027795		027825	
<b>AN</b> 2 Antracit RAL 7016	72,00	<b>87,84</b>	72,00	<b>87,84</b>	74,00	<b>90,28</b>
	026262		026293		026323	
<b>IC</b> 3 Črna intenzivno RAL 9005	72,00	<b>87,84</b>	72,00	<b>87,84</b>	74,00	<b>90,28</b>
	026569		026590		026620 *	
<b>OC</b> 4 Vinsko rdeča RAL 3009	72,00	<b>87,84</b>	72,00	<b>87,84</b>	74,00	<b>90,28</b>
	027313		027344		027375 *	
<b>MH</b> 5 Opečno rdeča RAL 8004	72,00	<b>87,84</b>	72,00	<b>87,84</b>	74,00	<b>90,28</b>
	026712 *		026743 *		026774 *	
<b>SB</b> 6 Umazano bela RAL 9002	72,00	<b>87,84</b>	72,00	<b>87,84</b>	74,00	<b>90,28</b>
	027610 *		027641		027672	
<b>BH</b> 7 Srebrna RAL 9006	72,00	<b>87,84</b>	72,00	<b>87,84</b>	74,00	<b>90,28</b>
	026415 *		026446		026477	
<b>PS</b> 8 Prašno siva RAL 7037	72,00	<b>87,84</b>	72,00	<b>87,84</b>	74,00	<b>90,28</b>
	027467 *		027498		027528	
<b>MM</b> 9 Metalik bakrena RAL extra	72,00	<b>87,84</b>	72,00	<b>87,84</b>	74,00	<b>90,28</b>
	026866 *		026897		026927 *	
<b>BHT – P.20</b> 10 Temno srebrna RAL 9007	72,00	<b>87,84</b>	72,00	<b>87,84</b>	74,00	<b>90,28</b>
	096203 *		096258		096302	
<b>MZ</b> 11 Zelena mahovo RAL 6005	72,00	<b>87,84</b>	72,00	<b>87,84</b>	74,00	<b>90,28</b>
	027160 *		027191 *		027221 *	
<b>MOT</b> 12 Temno modra RAL 5010	72,00	<b>87,84</b>	72,00	<b>87,84</b>	74,00	<b>90,28</b>
	027016 *		027047 *		027078 *	
<b>TZ</b> 13 Zelena svetlo RAL 6011	72,00	<b>87,84</b>	72,00	<b>87,84</b>	74,00	<b>90,28</b>
	027917 *		027948 *		027979 *	
<b>Pakiranje v kos</b>	<b>2</b>		<b>2</b>		<b>2</b>	
<b>Pakiranje v kos</b>	<b>36</b>		<b>36</b>		<b>36</b>	

\* Izdelava po meri

## ZBIRNI KOTLIČEK KUBICKI

## P-PKLZ KU



Nominalna velikost	80		100		120	
	Brez DDV	Z DDV	Brez DDV	Z DDV	Brez DDV	Z DDV
<b>TM</b> 1 Testa di Moro RAL 8028	88,00	<b>107,36</b>	88,00	<b>107,36</b>	94,00	<b>114,68</b>
	027719 *		027733		027757	
<b>AN</b> 2 Antracit RAL 7016	88,00	<b>107,36</b>	88,00	<b>107,36</b>	94,00	<b>114,68</b>
	026217		026231		026255	
<b>IC</b> 3 Črna intenzivno RAL 9005	88,00	<b>107,36</b>	88,00	<b>107,36</b>	94,00	<b>114,68</b>
	026514		026538		026552	
<b>OC</b> 4 Vinsko rdeča RAL 3009	88,00	<b>107,36</b>	88,00	<b>107,36</b>	94,00	<b>114,68</b>
	027269 *		027283 *		027306	
<b>MH</b> 5 Opečno rdeča RAL 8004	88,00	<b>107,36</b>	88,00	<b>107,36</b>	94,00	<b>114,68</b>
	026668 *		026682 *		026705 *	
<b>SB</b> 6 Umazano bela RAL 9002	88,00	<b>107,36</b>	88,00	<b>107,36</b>	94,00	<b>114,68</b>
	027566 *		027580 *		027603 *	
<b>BH</b> 7 Srebrna RAL 9006	88,00	<b>107,36</b>	88,00	<b>107,36</b>	94,00	<b>114,68</b>
	026361 *		026385		026408	
<b>PS</b> 8 Prašno siva RAL 7037	88,00	<b>107,36</b>	88,00	<b>107,36</b>	94,00	<b>114,68</b>
	027412 *		027436 *		027450	
<b>MM</b> 9 Metalik bakrena RAL extra	88,00	<b>107,36</b>	88,00	<b>107,36</b>	94,00	<b>114,68</b>
	026811 *		026835 *		026859 *	
<b>BHT – P.20</b> 10 Temno srebrna RAL 9007	88,00	<b>107,36</b>	88,00	<b>107,36</b>	94,00	<b>114,68</b>
	096241 *		096296 *		096340 *	
<b>MZ</b> 11 Zelena mahovo RAL 6005	88,00	<b>107,36</b>	88,00	<b>107,36</b>	94,00	<b>114,68</b>
	027115 *		027139 *		027153 *	
<b>MOT</b> 12 Temno modra RAL 5010	88,00	<b>107,36</b>	88,00	<b>107,36</b>	94,00	<b>114,68</b>
	026965 *		026989 *		026996 *	
<b>TZ</b> 13 Zelena svetlo RAL 6011	88,00	<b>107,36</b>	88,00	<b>107,36</b>	94,00	<b>114,68</b>
	027863 *		027887 *		027900 *	
<b>Pakiranje v kos</b> 	<b>2</b>		<b>2</b>		<b>2</b>	
<b>Pakiranje v kos</b> 	<b>36</b>		<b>36</b>		<b>36</b>	

\* Izdelava po meri



## ZBIRNI KOTLIČEK KUBICKI EKSCENTRIČEN

P-PKLZ KX





Nominalna velikost	80		100		120	
	Brez DDV	Z DDV	Brez DDV	Z DDV	Brez DDV	Z DDV
<b>TM</b> 1 Testa di Moro RAL 8028	88,00	<b>107,36</b>	88,00	<b>107,36</b>	94,00	<b>114,68</b>
	027788		027818		027849	
<b>AN</b> 2 Antracit RAL 7016	88,00	<b>107,36</b>	88,00	<b>107,36</b>	94,00	<b>114,68</b>
	026286		026316		026347	
<b>IC</b> 3 Črna intenzivno RAL 9005	88,00	<b>107,36</b>	88,00	<b>107,36</b>	94,00	<b>114,68</b>
	026583		026613		026644 *	
<b>OC</b> 4 Vinsko rdeča RAL 3009	88,00	<b>107,36</b>	88,00	<b>107,36</b>	94,00	<b>114,68</b>
	027337 *		027368		027399	
<b>MH</b> 5 Opečno rdeča RAL 8004	88,00	<b>107,36</b>	88,00	<b>107,36</b>	94,00	<b>114,68</b>
	026736		026767		026798 *	
<b>SB</b> 6 Umazano bela RAL 9002	88,00	<b>107,36</b>	88,00	<b>107,36</b>	94,00	<b>114,68</b>
	027634 *		027665		027696	
<b>BH</b> 7 Srebrna RAL 9006	88,00	<b>107,36</b>	88,00	<b>107,36</b>	94,00	<b>114,68</b>
	026439 *		026460		026491	
<b>PS</b> 8 Prašno siva RAL 7037	88,00	<b>107,36</b>	88,00	<b>107,36</b>	94,00	<b>114,68</b>
	027481 *		027511		027542	
<b>MM</b> 9 Metalik bakrena RAL extra	88,00	<b>107,36</b>	88,00	<b>107,36</b>	94,00	<b>114,68</b>
	026880 *		026910		026941 *	
<b>BHT – P.20</b> 10 Temno srebrna RAL 9007	88,00	<b>107,36</b>	88,00	<b>107,36</b>	94,00	<b>114,68</b>
	096227		096272		096326	
<b>MZ</b> 11 Zelena mahovo RAL 6005	88,00	<b>107,36</b>	88,00	<b>107,36</b>	94,00	<b>114,68</b>
	027184 *		027214		027245 *	
<b>MOT</b> 12 Temno modra RAL 5010	88,00	<b>107,36</b>	88,00	<b>107,36</b>	94,00	<b>114,68</b>
	027030 *		027061 *		027092 *	
<b>TZ</b> 13 Zelena svetlo RAL 6011	88,00	<b>107,36</b>	88,00	<b>107,36</b>	94,00	<b>114,68</b>
	027931 *		027962		027993 *	
<b>Pakiranje v kos</b>	<b>2</b>		<b>2</b>		<b>2</b>	
<b>Pakiranje v kos</b>	<b>36</b>		<b>36</b>		<b>36</b>	

\* Izdelava po meri

## ZBIRNI KOTLIČEK KUBICKI EKSCENTRIČEN ISPUSTOM P-PKLZ KXV



Nominalna velikost	80		100		120	
	Brez DDV	Z DDV	Brez DDV	Z DDV	Brez DDV	Z DDV
<b>TM</b> 1 Testa di Moro RAL 8028	115,00	<b>140,30</b>	115,00	<b>140,30</b>	115,00	<b>140,30</b>
	027771 *		027801 *		027832 *	
<b>AN</b> 2 Antracit RAL 7016	115,00	<b>140,30</b>	115,00	<b>140,30</b>	115,00	<b>140,30</b>
	026279 *		026309 *		026330 *	
<b>IC</b> 3 Črna intenzivno RAL 9005	115,00	<b>140,30</b>	115,00	<b>140,30</b>	115,00	<b>140,30</b>
	026576 *		026606		026637 *	
<b>OC</b> 4 Vinsko rdeča RAL 3009	115,00	<b>140,30</b>	115,00	<b>140,30</b>	115,00	<b>140,30</b>
	027320 *		027351 *		027382 *	
<b>MH</b> 5 Opečno rdeča RAL 8004	115,00	<b>140,30</b>	115,00	<b>140,30</b>	115,00	<b>140,30</b>
	026729 *		026750 *		026781 *	
<b>SB</b> 6 Umazano bela RAL 9002	115,00	<b>140,30</b>	115,00	<b>140,30</b>	115,00	<b>140,30</b>
	027627 *		027658 *		027689 *	
<b>BH</b> 7 Srebrna RAL 9006	115,00	<b>140,30</b>	115,00	<b>140,30</b>	115,00	<b>140,30</b>
	026422 *		026453 *		026484 *	
<b>PS</b> 8 Prašno siva RAL 7037	115,00	<b>140,30</b>	115,00	<b>140,30</b>	115,00	<b>140,30</b>
	027474 *		027504 *		027535 *	
<b>MM</b> 9 Metalik bakrena RAL extra	115,00	<b>140,30</b>	115,00	<b>140,30</b>	115,00	<b>140,30</b>
	026873 *		026903 *		026934 *	
<b>BHT – P.20</b> 10 Temno srebrna RAL 9007	115,00	<b>140,30</b>	115,00	<b>140,30</b>	115,00	<b>140,30</b>
	096234 *		096289 *		096333 *	
<b>MZ</b> 11 Zelena mahovo RAL 6005	115,00	<b>140,30</b>	115,00	<b>140,30</b>	115,00	<b>140,30</b>
	027177 *		027207 *		027238 *	
<b>MOT</b> 12 Temno modra RAL 5010	115,00	<b>140,30</b>	115,00	<b>140,30</b>	115,00	<b>140,30</b>
	027023 *		027054 *		027085 *	
<b>TZ</b> 13 Zelena svetlo RAL 6011	115,00	<b>140,30</b>	115,00	<b>140,30</b>	115,00	<b>140,30</b>
	027924 *		027955 *		027986 *	
<b>Pakiranje v kos</b> 	<b>2</b>		<b>2</b>		<b>2</b>	
<b>Pakiranje v kos</b> 	<b>36</b>		<b>36</b>		<b>36</b>	

\* Izdelava po meri

## TESNILNA GUMA ZBIRNEGA KOTLIČKA

P-PKLZ T



Nominalna velikost	EAN številko izdelka	Pakiranje v kos		Cena [€/kos]	
				Brez DDV	Z DDV
<b>IC 70-85</b>	077103	5	600	4,00	<b>4,88</b>
<b>IC 100-110</b>	077110	5	600	4,10	<b>5,00</b>
<b>IC 110-125</b>	077097	5	600	4,20	<b>5,12</b>
<b>PS 70-85</b>	077134	5	600	4,50	<b>5,49</b>
<b>PS 100-110</b>	077141	5	600	4,90	<b>5,98</b>
<b>PS 110-125</b>	077127	5	600	5,00	<b>6,10</b>

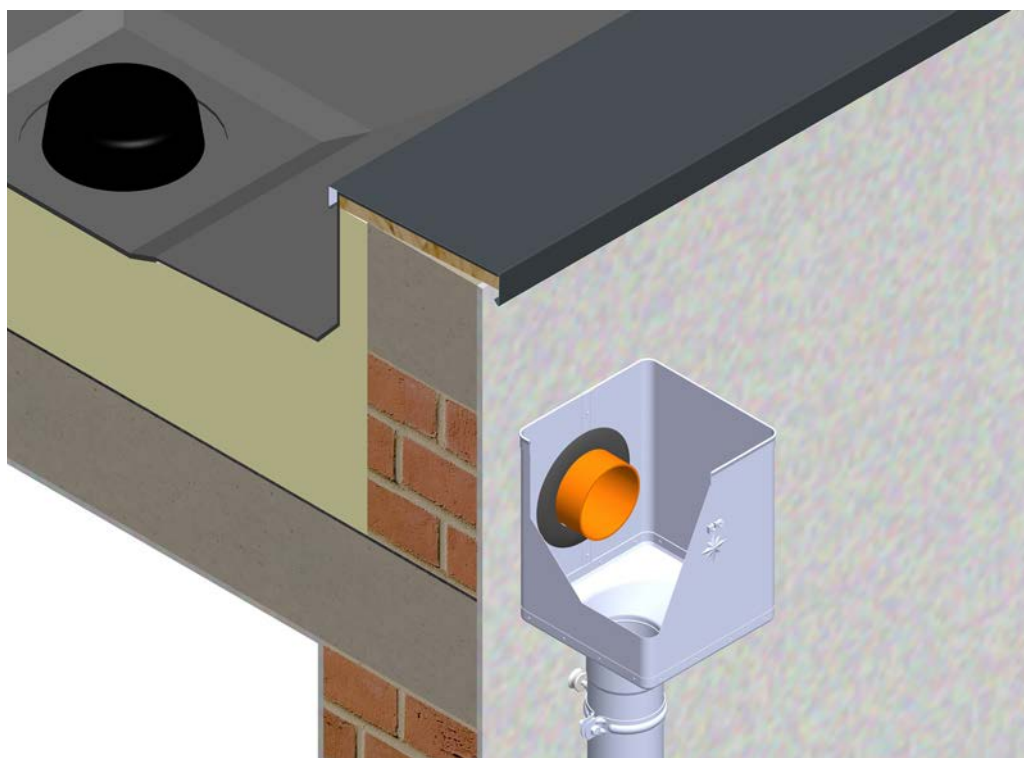

## ODTOČNO KOLENO 72°

P-PK



Nominalna velikost	60		80		100		120		150	
	Brez DDV	Z DDV	Brez DDV	Z DDV	Brez DDV	Z DDV	Brez DDV	Z DDV	Brez DDV	Z DDV
<b>TM</b> 1 Testa di Moro RAL 8028	6,00	<b>7,32</b>	5,50	<b>6,71</b>	6,00	<b>7,32</b>	8,50	<b>10,37</b>	19,95	<b>24,34</b>
	072542		072559		072573		072597		033697	
<b>AN</b> 2 Antracit RAL 7016	6,00	<b>7,32</b>	5,50	<b>6,71</b>	6,00	<b>7,32</b>	8,50	<b>10,37</b>	19,95	<b>24,34</b>
	071842		071859		071873		071897		033598	
<b>IC</b> 3 Črna intenzivno RAL 9005	6,00	<b>7,32</b>	5,50	<b>6,71</b>	6,00	<b>7,32</b>	8,50	<b>10,37</b>	19,95	<b>24,34</b>
	071989		072023		072009		072030		033611	
<b>OC</b> 4 Vinsko rdeča RAL 3009	6,00	<b>7,32</b>	5,50	<b>6,71</b>	6,00	<b>7,32</b>	8,50	<b>10,37</b>	19,95	<b>24,34</b>
	072337		072344		072368		072382		033666	
<b>MH</b> 5 Opečno rdeča RAL 8004	6,00	<b>7,32</b>	5,50	<b>6,71</b>	6,00	<b>7,32</b>	8,50	<b>10,37</b>	19,95	<b>24,34</b>
	072054		072061		072085		072108		033628	
<b>SB</b> 6 Umazano bela RAL 9002	6,00	<b>7,32</b>	5,50	<b>6,71</b>	6,00	<b>7,32</b>	8,50	<b>10,37</b>	19,95	<b>24,34</b>
	072474		072481		072504		072528		033680	
<b>BH</b> 7 Srebrna RAL 9006	6,00	<b>7,32</b>	5,50	<b>6,71</b>	6,00	<b>7,32</b>	8,50	<b>10,37</b>	19,95	<b>24,34</b>
	071910		071927		071941		071965		033604	
<b>PS</b> 8 Prašno siva RAL 7037	6,00	<b>7,32</b>	5,50	<b>6,71</b>	6,00	<b>7,32</b>	8,50	<b>10,37</b>	19,95	<b>24,34</b>
	072405		072412		072429		072443		033673	
<b>MM</b> 9 Metalik bakrena RAL extra	6,00	<b>7,32</b>	5,50	<b>6,71</b>	6,00	<b>7,32</b>	8,50	<b>10,37</b>	19,95	<b>24,34</b>
	072122		072139		072153		072160		033635	
<b>BHT – P.20</b> 10 Temno srebrna RAL 9007	6,00	<b>7,32</b>	5,50	<b>6,71</b>	6,00	<b>7,32</b>	8,50	<b>10,37</b>	19,95	<b>24,34</b>
	118691 *		095183		095206		095220		095244	
<b>MZ</b> 11 Zelena mahovo RAL 6005	6,00	<b>7,32</b>	5,50	<b>6,71</b>	6,00	<b>7,32</b>	8,50	<b>10,37</b>	19,95	<b>24,34</b>
	072269		072276		072290		072313		033659	
<b>MOT</b> 12 Temno modra RAL 5010	6,00	<b>7,32</b>	5,50	<b>6,71</b>	6,00	<b>7,32</b>	8,50	<b>10,37</b>	19,95	<b>24,34</b>
	072191		072207		072221		072245		033642	
<b>TZ</b> 13 Zelena svetlo RAL 6011	6,00	<b>7,32</b>	5,50	<b>6,71</b>	6,00	<b>7,32</b>	8,50	<b>10,37</b>	19,95	<b>24,34</b>
	072610 *		072627		072641		072665		033703 *	
<b>Pakiranje v kos</b>	<b>25</b>		<b>25</b>		<b>25</b>		<b>15</b>		<b>5</b>	
<b>Pakiranje v kos</b>	<b>600</b>		<b>400</b>		<b>300</b>		<b>180</b>		<b>90</b>	

\* Izdelava po meri



## ODTOČNO KOLENO 85°

P-PKR



Nominalna velikost	80		100		120	
	Brez DDV	Z DDV	Brez DDV	Z DDV	Brez DDV	Z DDV
<b>TM</b> 1 Testa di Moro RAL 8028	6,90	<b>8,42</b>	7,80	<b>9,52</b>	12,40	<b>15,13</b>
	072566		072580		072603	
<b>AN</b> 2 Antracit RAL 7016	6,90	<b>8,42</b>	7,80	<b>9,52</b>	12,40	<b>15,13</b>
	071866		071880		071903	
<b>IC</b> 3 Črna intenzivno RAL 9005	6,90	<b>8,42</b>	7,80	<b>9,52</b>	12,40	<b>15,13</b>
	071996		072016		072047	
<b>OC</b> 4 Vinsko rdeča RAL 3009	6,90	<b>8,42</b>	7,80	<b>9,52</b>	12,40	<b>15,13</b>
	072351		072375		072399	
<b>MH</b> 5 Opečno rdeča RAL 8004	6,90	<b>8,42</b>	7,80	<b>9,52</b>	12,40	<b>15,13</b>
	072078		072092		072115	
<b>SB</b> 6 Umazano bela RAL 9002	6,90	<b>8,42</b>	7,80	<b>9,52</b>	12,40	<b>15,13</b>
	072498		072511		072535	
<b>BH</b> 7 Srebrna RAL 9006	6,90	<b>8,42</b>	7,80	<b>9,52</b>	12,40	<b>15,13</b>
	071934		071958		071972	
<b>PS</b> 8 Prašno siva RAL 7037	6,90	<b>8,42</b>	7,80	<b>9,52</b>	12,40	<b>15,13</b>
	072467		072436		072450	
<b>MM</b> 9 Metalik bakrena RAL extra	6,90	<b>8,42</b>	7,80	<b>9,52</b>	12,40	<b>15,13</b>
	072146		072184		072177	
<b>BHT – P.20</b> 10 Temno srebrna RAL 9007	6,90	<b>8,42</b>	7,80	<b>9,52</b>	12,40	<b>15,13</b>
	095190		095213		095237 *	
<b>MZ</b> 11 Zelena mahovo RAL 6005	6,90	<b>8,42</b>	7,80	<b>9,52</b>	12,40	<b>15,13</b>
	072283		072306		072320	
<b>MOT</b> 12 Temno modra RAL 5010	6,90	<b>8,42</b>	7,80	<b>9,52</b>	12,40	<b>15,13</b>
	072214 *		072238 *		072252 *	
<b>TZ</b> 13 Zelena svetlo RAL 6011	6,90	<b>8,42</b>	7,80	<b>9,52</b>	12,40	<b>15,13</b>
	072634 *		072658 *		072672 *	
<b>Pakiranje v kos</b> 	<b>25</b>		<b>25</b>		<b>15</b>	
<b>Pakiranje v kos</b> 	<b>400</b>		<b>300</b>		<b>180</b>	

\* Izdelava po meri



## ODTOČNO KOLENO 40°

P-PKT

Nominalna velikost	80		100		120	
	Brez DDV	Z DDV	Brez DDV	Z DDV	Brez DDV	Z DDV
<b>TM</b> 1 Testa di Moro RAL 8028	6,50	<b>7,93</b>	7,10	<b>8,66</b>	10,00	<b>12,20</b>
	072993		073006		073013	
<b>AN</b> 2 Antracit RAL 7016	6,50	<b>7,93</b>	7,10	<b>8,66</b>	10,00	<b>12,20</b>
	072696		072702		072719	
<b>IC</b> 3 Črna intenzivno RAL 9005	6,50	<b>7,93</b>	7,10	<b>8,66</b>	10,00	<b>12,20</b>
	072757		072764		072771	
<b>OC</b> 4 Vinsko rdeča RAL 3009	6,50	<b>7,93</b>	7,10	<b>8,66</b>	10,00	<b>12,20</b>
	072900		072917		072924	
<b>MH</b> 5 Opečno rdeča RAL 8004	6,50	<b>7,93</b>	7,10	<b>8,66</b>	10,00	<b>12,20</b>
	072795		072788		072801	
<b>SB</b> 6 Umazano bela RAL 9002	6,50	<b>7,93</b>	7,10	<b>8,66</b>	10,00	<b>12,20</b>
	072962		072979		072986	
<b>BH</b> 7 Srebrna RAL 9006	6,50	<b>7,93</b>	7,10	<b>8,66</b>	10,00	<b>12,20</b>
	072726		072733		072740	
<b>PS</b> 8 Prašno siva RAL 7037	6,50	<b>7,93</b>	7,10	<b>8,66</b>	10,00	<b>12,20</b>
	072931		072948		072955	
<b>MM</b> 9 Metalik bakrena RAL extra	6,50	<b>7,93</b>	7,10	<b>8,66</b>	10,00	<b>12,20</b>
	072818		072825		072832 *	
<b>BHT – P.20</b> 10 Temno srebrna RAL 9007	6,50	<b>7,93</b>	7,10	<b>8,66</b>	10,00	<b>12,20</b>
	094711		094728		094735	
<b>MZ</b> 11 Zelena mahovo RAL 6005	6,50	<b>7,93</b>	7,10	<b>8,66</b>	10,00	<b>12,20</b>
	072870 *		072887		072894	
<b>MOT</b> 12 Temno modra RAL 5010	6,50	<b>7,93</b>	7,10	<b>8,66</b>	10,00	<b>12,20</b>
	072849		072856		072863	
<b>TZ</b> 13 Zelena svetlo RAL 6011	6,50	<b>7,93</b>	7,10	<b>8,66</b>	10,00	<b>12,20</b>
	073020 *		073037 *		073044 *	
<b>Pakiranje v kos</b> 	<b>25</b>		<b>25</b>		<b>15</b>	
<b>Pakiranje v kos</b> 	<b>400</b>		<b>300</b>		<b>240</b>	

\* Izdelava po meri



## ZAKLJUČNO ODTOČNO KOLENO 72°

P-PKV



Nominalna velikost	80		100		120	
	Brez DDV	Z DDV	Brez DDV	Z DDV	Brez DDV	Z DDV
<b>TM</b> 1 Testa di Moro RAL 8028	6,50	<b>7,93</b>	7,00	<b>8,54</b>	9,50	<b>11,59</b>
	095046		095053		095060	
<b>AN</b> 2 Antracit RAL 7016	6,50	<b>7,93</b>	7,00	<b>8,54</b>	9,50	<b>11,59</b>
	094742		094759		094766	
<b>IC</b> 3 Črna intenzivno RAL 9005	6,50	<b>7,93</b>	7,00	<b>8,54</b>	9,50	<b>11,59</b>
	094803		094810		094827 *	
<b>OC</b> 4 Vinsko rdeča RAL 3009	6,50	<b>7,93</b>	7,00	<b>8,54</b>	9,50	<b>11,59</b>
	094957 *		094964		094971 *	
<b>MH</b> 5 Opečno rdeča RAL 8004	6,50	<b>7,93</b>	7,00	<b>8,54</b>	9,50	<b>11,59</b>
	094834		094841		094858	
<b>SB</b> 6 Umazano bela RAL 9002	6,50	<b>7,93</b>	7,00	<b>8,54</b>	9,50	<b>11,59</b>
	095015 *		095022		095039	
<b>BH</b> 7 Srebrna RAL 9006	6,50	<b>7,93</b>	7,00	<b>8,54</b>	9,50	<b>11,59</b>
	094773 *		094780		094797	
<b>PS</b> 8 Prašno siva RAL 7037	6,50	<b>7,93</b>	7,00	<b>8,54</b>	9,50	<b>11,59</b>
	094988 *		094995 *		095008 *	
<b>MM</b> 9 Metalik bakrena RAL extra	6,50	<b>7,93</b>	7,00	<b>8,54</b>	9,50	<b>11,59</b>
	094865 *		094872 *		094889 *	
<b>BHT – P.20</b> 10 Temno srebrna RAL 9007	6,50	<b>7,93</b>	7,00	<b>8,54</b>	9,50	<b>11,59</b>
	124739 *		124746 *		124753 *	
<b>MZ</b> 11 Zelena mahovo RAL 6005	6,50	<b>7,93</b>	7,00	<b>8,54</b>	9,50	<b>11,59</b>
	094926 *		094933 *		094940 *	
<b>MOT</b> 12 Temno modra RAL 5010	6,50	<b>7,93</b>	7,00	<b>8,54</b>	9,50	<b>11,59</b>
	094896 *		094902 *		094919 *	
<b>TZ</b> 13 Zelena svetlo RAL 6011	6,50	<b>7,93</b>	7,00	<b>8,54</b>	9,50	<b>11,59</b>
	095077 *		095084 *		095091 *	
<b>Pakiranje v kos</b>	<b>25</b>		<b>25</b>		<b>15</b>	
<b>Pakiranje v kos</b>	<b>400</b>		<b>300</b>		<b>180</b>	

\* Izdelava po meri

# POCINKANO POLYESTER

## KOLENO FALCANO 72°

P-PKF2



Nominalna velikost	60		80		100		120	
Cena v €/kos	Brez DDV	Z DDV	Brez DDV	Z DDV	Brez DDV	Z DDV	Brez DDV	Z DDV
<b>TM</b> 1 Testa di Moro RAL 8028	4,30	<b>5,25</b>	3,40	<b>4,15</b>	4,40	<b>5,37</b>	6,30	<b>7,69</b>
	071781		071798		071811		071828	
Pakiranje v kos	10		10		10		8	
Pakiranje v kos	3 000		1 200		800		576	

## KOLENO FALCANO 85°

P-PKF3



Nominalna velikost	80		100	
Cena v €/kos	Brez DDV	Z DDV	Brez DDV	Z DDV
<b>TM</b> 1 Testa di Moro RAL 8028	4,40	<b>5,37</b>	6,30	<b>7,69</b>
	071804		071835	
Pakiranje v kos	10		10	
Pakiranje v kos	1 200		800	

## PVC CEVNA FOLIJA

SD-ZR FOLIA KJG



Nominalna velikost	Dolžina v m	EAN številko izdelka	Pakiranje v m		Cena [€/kos]	
					Brez DDV	Z DDV
<b>60-150</b>	100,0	139726	100	6 000	0,38	<b>0,46</b>



**CEV ODVODNA [s=0,55]**
**P-PZR**

Nominalna velikost	60		60		80		80		80	
Dolžina v m	2,0		3,0		1,0		2,0		3,0	
Cena v €/m	Brez DDV	Z DDV	Brez DDV	Z DDV	Brez DDV	Z DDV	Brez DDV	Z DDV	Brez DDV	Z DDV
<b>TM</b> 1 Testa di Moro RAL 8028	8,00	<b>9,76</b>	8,00	<b>9,76</b>	7,20	<b>8,78</b>	7,20	<b>8,78</b>	7,00	<b>8,54</b>
	071309		071316		071323		071330		071347	
<b>AN</b> 2 Antracit RAL 7016	8,00	<b>9,76</b>	8,00	<b>9,76</b>	7,20	<b>8,78</b>	7,20	<b>8,78</b>	7,00	<b>8,54</b>
	069467		069474		069481		069498		069504	
<b>IC</b> 3 Črna intenzivno RAL 9005	8,00	<b>9,76</b>	8,00	<b>9,76</b>	7,20	<b>8,78</b>	7,20	<b>8,78</b>	7,00	<b>8,54</b>
	069900		069917		069924		069931		069948	
<b>OC</b> 4 Vinsko rdeča RAL 3009	8,00	<b>9,76</b>	8,00	<b>9,76</b>	7,20	<b>8,78</b>	7,20	<b>8,78</b>	7,00	<b>8,54</b>
	070661		070678		070685		070692		070708	
<b>MH</b> 5 Opečno rdeča RAL 8004	8,10	<b>9,88</b>			7,30	<b>8,91</b>	7,30	<b>8,91</b>	7,10	<b>8,66</b>
	070128				070142		070159		070166	
<b>SB</b> 6 Umazano bela RAL 9002	8,10	<b>9,88</b>	8,10	<b>9,88</b>	7,30	<b>8,91</b>	7,30	<b>8,91</b>	7,10	<b>8,66</b>
	071088		071095		071101		071118		071125	
<b>BH</b> 7 Srebrna RAL 9006	8,10	<b>9,88</b>	8,10	<b>9,88</b>	7,30	<b>8,91</b>	7,30	<b>8,91</b>	7,10	<b>8,66</b>
	069689		069696		069702		069719		069726	
<b>PS</b> 8 Prašno siva RAL 7037	8,10	<b>9,88</b>	8,10	<b>9,88</b>	7,30	<b>8,91</b>	7,30	<b>8,91</b>	7,10	<b>8,66</b>
	070883		070890		070906		070913		070920	
<b>MM</b> 9 Metalik bakrena RAL extra	8,50	<b>10,37</b>			7,75	<b>9,46</b>	7,75	<b>9,46</b>	7,55	<b>9,21</b>
	070340				070364		070371		070388	
<b>BHT – P.20</b> 10 Temno srebrna RAL 9007									8,55	<b>10,43</b>
									096128	
<b>MZ</b> 11 Zelena mahovo RAL 6005	8,50	<b>10,37</b>							7,55	<b>9,21</b>
	070586								070593	
<b>MOT</b> 12 Temno modra RAL 5010	8,50	<b>10,37</b>							7,55	<b>9,21</b>
	070494								070500	
<b>TZ</b> 13 Zelena svetlo RAL 6011	8,50	<b>10,37</b>					7,75	<b>9,46</b>		
	071521 *						071538			
<b>Pakiranje v m</b> 	<b>10</b>		<b>15</b>		<b>10</b>		<b>10</b>		<b>15</b>	
<b>Pakiranje v m</b> 	<b>490</b>		<b>735</b>		<b>100</b>		<b>250</b>		<b>375</b>	

\* Izdelava po meri



# POCINKANO POLYESTER

## CEV ODVODNA [s=0,55]

P-PZR

Nominalna velikost	80		80		80		100		100	
Dolžina v m	4,0		5,0		6,0		1,0		2,0	
Cena v €/m	Brez DDV	Z DDV	Brez DDV	Z DDV	Brez DDV	Z DDV	Brez DDV	Z DDV	Brez DDV	Z DDV
<b>TM</b> 1 Testa di Moro RAL 8028	7,00	<b>8,54</b>	7,00	<b>8,54</b>	7,00	<b>8,54</b>	7,40	<b>9,03</b>	7,40	<b>9,03</b>
	071354		071361 *		071378 *		071385		071392	
<b>AN</b> 2 Antracit RAL 7016	7,00	<b>8,54</b>	7,00	<b>8,54</b>	7,00	<b>8,54</b>	7,40	<b>9,03</b>	7,40	<b>9,03</b>
	069511		069528 *		069535 *		069542		069559	
<b>IC</b> 3 Črna intenzivno RAL 9005	7,00	<b>8,54</b>	7,00	<b>8,54</b>	7,00	<b>8,54</b>	7,40	<b>9,03</b>	7,40	<b>9,03</b>
	069955		069962 *		069979 *		069986		069993	
<b>OC</b> 4 Vinsko rdeča RAL 3009	7,00	<b>8,54</b>	7,00	<b>8,54</b>	7,00	<b>8,54</b>	7,40	<b>9,03</b>	7,40	<b>9,03</b>
	070715		070722 *		070739 *		070746		070753	
<b>MH</b> 5 Opečno rdeča RAL 8004	7,10	<b>8,66</b>	7,10	<b>8,66</b>	7,10	<b>8,66</b>	7,50	<b>9,15</b>	7,50	<b>9,15</b>
	070173		070180 *		070197 *		070203		070210	
<b>SB</b> 6 Umazano bela RAL 9002	7,10	<b>8,66</b>	7,10	<b>8,66</b>	7,10	<b>8,66</b>	7,50	<b>9,15</b>	7,50	<b>9,15</b>
	071132		071149 *		071156 *		071163		071170	
<b>BH</b> 7 Srebrna RAL 9006	7,10	<b>8,66</b>	7,10	<b>8,66</b>	7,10	<b>8,66</b>	7,50	<b>9,15</b>	7,50	<b>9,15</b>
	069733		069740 *		069757 *		069764		069771	
<b>PS</b> 8 Prašno siva RAL 7037	7,10	<b>8,66</b>	7,10	<b>8,66</b>	7,10	<b>8,66</b>	7,50	<b>9,15</b>	7,50	<b>9,15</b>
	070937		070944 *		070951 *		070968		070975	
<b>MM</b> 9 Metalik bakrena RAL extra	7,55	<b>9,21</b>					8,40	<b>10,25</b>	8,40	<b>10,25</b>
	070395						070401		070418	
<b>BHT – P.20</b> 10 Temno srebrna RAL 9007										
<b>MZ</b> 11 Zelena mahovo RAL 6005	7,55	<b>9,21</b>								
	070609									
<b>MOT</b> 12 Temno modra RAL 5010										
<b>TZ</b> 13 Zelena svetlo RAL 6011										
<b>Pakiranje v m</b> 📦	<b>20</b>		<b>5</b>		<b>6</b>		<b>10</b>		<b>10</b>	
<b>Pakiranje v m</b> 🚚	<b>500</b>		<b>625</b>		<b>750</b>		<b>70</b>		<b>160</b>	

\* Izdelava po meri

POCINKANO  
POLYESTER



**CEV ODVODNA [s=0,55]**
**P-PZR**

Nominalna velikost	100		100		100		100		120		
Dolžina v m	3,0		4,0		5,0		6,0		1,0		
Cena v €/m	Brez DDV	Z DDV	Brez DDV	Z DDV	Brez DDV	Z DDV	Brez DDV	Z DDV	Brez DDV	Z DDV	
<b>TM</b> Testa di Moro RAL 8028	1	7,20	<b>8,78</b>	7,20	<b>8,78</b>	7,20	<b>8,78</b>	7,20	<b>8,78</b>	10,75	<b>13,12</b>
		071408		071415		071422		071439 *		071446	
<b>AN</b> Antracit RAL 7016	2	7,20	<b>8,78</b>	7,20	<b>8,78</b>	7,20	<b>8,78</b>	7,20	<b>8,78</b>	10,75	<b>13,12</b>
		069566		069573		069580		069597 *		069603	
<b>IC</b> Črna intenzivno RAL 9005	3	7,20	<b>8,78</b>	7,20	<b>8,78</b>	7,20	<b>8,78</b>	7,20	<b>8,78</b>	10,75	<b>13,12</b>
		070005		070012		070029		070036 *		070043	
<b>OC</b> Vinsko rdeča RAL 3009	4	7,20	<b>8,78</b>	7,20	<b>8,78</b>	7,20	<b>8,78</b>	7,20	<b>8,78</b>	10,75	<b>13,12</b>
		070760		070777		070784 *		070791 *		070807	
<b>MH</b> Opečno rdeča RAL 8004	5	7,30	<b>8,91</b>	7,30	<b>8,91</b>	7,30	<b>8,91</b>	7,30	<b>8,91</b>	10,85	<b>13,24</b>
		070227		070234		070241 *		070258 *		070265	
<b>SB</b> Umazano bela RAL 9002	6	7,30	<b>8,91</b>	7,30	<b>8,91</b>	7,30	<b>8,91</b>	7,30	<b>8,91</b>	10,85	<b>13,24</b>
		071187		071194		071200 *		071217 *		071224	
<b>BH</b> Srebrna RAL 9006	7	7,30	<b>8,91</b>	7,30	<b>8,91</b>	7,30	<b>8,91</b>	7,30	<b>8,91</b>	10,85	<b>13,24</b>
		069788		069795		069801 *		069818 *		069825	
<b>PS</b> Prašno siva RAL 7037	8	7,30	<b>8,91</b>	7,30	<b>8,91</b>	7,30	<b>8,91</b>	7,30	<b>8,91</b>	10,85	<b>13,24</b>
		070982		070999		071002 *		071019 *		071026	
<b>MM</b> Metalik bakrena RAL extra	9	8,20	<b>10,00</b>	8,20	<b>10,00</b>					11,50	<b>14,03</b>
		070425		070432						070449	
<b>BHT – P.20</b> Temno srebrna RAL 9007	10	8,80	<b>10,74</b>	8,80	<b>10,74</b>						
		096135		096142							
<b>MZ</b> Zelena mahovo RAL 6005	11	8,20	<b>10,00</b>	8,20	<b>10,00</b>						
		070616		070623							
<b>MOT</b> Temno modra RAL 5010	12	8,20	<b>10,00</b>	8,20	<b>10,00</b>						
		070524		070531							
<b>TZ</b> Zelena svetlo RAL 6011	13	8,20	<b>10,00</b>	8,20	<b>10,00</b>						
		071545		071552							
<b>Pakiranje v m</b> 		15		20		5		6		8	
<b>Pakiranje v m</b> 		240		320		400		480		48	

\* Izdelava po meri



**CEV ODVODNA [s=0,55]**
**P-PZR**

Nominalna velikost	120		120		120		120		120	
Dolžina v m	2,0		3,0		4,0		5,0		6,0	
Cena v €/m	Brez DDV	Z DDV	Brez DDV	Z DDV	Brez DDV	Z DDV	Brez DDV	Z DDV	Brez DDV	Z DDV
<b>TM</b> Testa di Moro RAL 8028	10,75	<b>13,12</b>	10,55	<b>12,87</b>	10,55	<b>12,87</b>	10,55	<b>12,87</b>	10,55	<b>12,87</b>
	071453		071460		071477		071484 *		071491 *	
<b>AN</b> Antracit RAL 7016	10,75	<b>13,12</b>	10,55	<b>12,87</b>	10,55	<b>12,87</b>	10,55	<b>12,87</b>	10,55	<b>12,87</b>
	069610		069627		069634		069641 *		069658 *	
<b>IC</b> Črna intenzivno RAL 9005	10,75	<b>13,12</b>	10,55	<b>12,87</b>	10,55	<b>12,87</b>	10,55	<b>12,87</b>	10,55	<b>12,87</b>
	070050		070067		070074		070081 *		070098 *	
<b>OC</b> Vinsko rdeča RAL 3009	10,75	<b>13,12</b>	10,55	<b>12,87</b>	10,55	<b>12,87</b>	10,55	<b>12,87</b>	10,55	<b>12,87</b>
	070814		070821		070838		070845 *		070852 *	
<b>MH</b> Opečno rdeča RAL 8004	10,85	<b>13,24</b>	10,65	<b>12,99</b>	10,65	<b>12,99</b>	10,65	<b>12,99</b>	10,65	<b>12,99</b>
	070272		070289		070296		070302 *		070319 *	
<b>SB</b> Umazano bela RAL 9002	10,85	<b>13,24</b>	10,65	<b>12,99</b>	10,65	<b>12,99</b>	10,65	<b>12,99</b>	10,65	<b>12,99</b>
	071231		071248		071255		071262		071279 *	
<b>BH</b> Srebrna RAL 9006	10,85	<b>13,24</b>	10,65	<b>12,99</b>	10,65	<b>12,99</b>	10,65	<b>12,99</b>	10,65	<b>12,99</b>
	069832		069849		069856		069863		069870 *	
<b>PS</b> Prašno siva RAL 7037	10,85	<b>13,24</b>	10,65	<b>12,99</b>	10,65	<b>12,99</b>				
	071033		071040		071057					
<b>MM</b> Metalik bakrena RAL extra	11,50	<b>14,03</b>	11,35	<b>13,85</b>	11,35	<b>13,85</b>				
	070456		070463		070470					
<b>BHT – P.20</b> Temno srebrna RAL 9007			12,05	<b>14,70</b>						
			096159							
<b>MZ</b> Zelena mahovo RAL 6005			11,35	<b>13,85</b>	11,35	<b>13,85</b>				
			070630		070647					
<b>MOT</b> Temno modra RAL 5010			11,35	<b>13,85</b>	11,35	<b>13,85</b>				
			070548		070555					
<b>TZ</b> Zelena svetlo RAL 6011			11,35	<b>13,85</b>	11,35	<b>13,85</b>				
			071569		071576					
<b>Pakiranje v m</b>	<b>10</b>		<b>15</b>		<b>20</b>		<b>5</b>		<b>6</b>	
<b>Pakiranje v m</b>	<b>120</b>		<b>180</b>		<b>240</b>		<b>300</b>		<b>360</b>	

\* Izdelava po meri



**CEV ODVODNA [s=0,55]**
**P-PZR**

Nominalna velikost	150		150	
Dolžina v m	3,0		4,0	
Cena v €/m	Brez DDV	Z DDV	Brez DDV	Z DDV
<b>TM</b> 1 Testa di Moro RAL 8028	20,60	<b>25,13</b>	20,60	<b>25,13</b>
	071507		071514	
<b>AN</b> 2 Antracit RAL 7016	20,60	<b>25,13</b>	20,60	<b>25,13</b>
	069665		069672	
<b>IC</b> 3 Črna intenzivno RAL 9005			20,60	<b>25,13</b>
			070111	
<b>OC</b> 4 Vinsko rdeča RAL 3009			20,60	<b>25,13</b>
			070876	
<b>MH</b> 5 Opečno rdeča RAL 8004	20,70	<b>25,25</b>		
	070326			
<b>SB</b> 6 Umazano bela RAL 9002	20,70	<b>25,25</b>	20,70	<b>25,25</b>
	071286		071293	
<b>BH</b> 7 Srebrna RAL 9006	20,70	<b>25,25</b>	20,70	<b>25,25</b>
	069887		069894	
<b>PS</b> 8 Prašno siva RAL 7037	20,70	<b>25,25</b>	20,70	<b>25,25</b>
	071064		071071	
<b>MM</b> 9 Metalik bakrena RAL extra	21,80	<b>26,60</b>		
	070487			
<b>BHT – P.20</b> 10 Temno srebrna RAL 9007	22,25	<b>27,15</b>		
	096166			
<b>MZ</b> 11 Zelena mahovo RAL 6005	21,80	<b>26,60</b>		
	070654			
<b>MOT</b> 12 Temno modra RAL 5010			21,80	<b>26,60</b>
			070579	
<b>TZ</b> 13 Zelena svetlo RAL 6011	21,80	<b>26,60</b>		
	071583 *			
<b>Pakiranje v m</b> 	<b>3</b>		<b>4</b>	
<b>Pakiranje v m</b> 	<b>84</b>		<b>112</b>	

\* Izdelava po meri



# POCINKANO POLYESTER

## CEV ODVODNA [s=0,50]

P-PZR

Nominalna velikost	80		80		80		80		80	
Dolžina v m	1,0		2,0		3,0		4,0		5,0	
Cena v €/m	Brez DDV		Brez DDV		Brez DDV		Brez DDV		Brez DDV	
<b>TM</b> Testa di Moro RAL 8028	5,95	<b>7,26</b>	5,95	<b>7,26</b>	5,75	<b>7,02</b>	5,75	<b>7,02</b>	5,75	<b>7,02</b>
	068538 *		068545 *		068552		068569 *		068576 *	
<b>AN</b> Antracit RAL 7016	5,25	<b>6,41</b>	5,25	<b>6,41</b>	5,10	<b>6,22</b>	5,10	<b>6,22</b>	5,10	<b>6,22</b>
	067869 *		067876 *		067883		067890 *		067906 *	
<b>IC</b> Črna intenzivno RAL 9005	5,95	<b>7,26</b>	5,95	<b>7,26</b>	5,75	<b>7,02</b>	5,75	<b>7,02</b>	5,75	<b>7,02</b>
	068217 *		068224 *		068231		068248 *		068255 *	
<b>OC</b> Vinsko rdeča RAL 3009	5,95	<b>7,26</b>	5,95	<b>7,26</b>	5,75	<b>7,02</b>	5,75	<b>7,02</b>	5,75	<b>7,02</b>
	068378 *		068385 *		068392		068408 *		068415 *	
<b>BH</b> Srebrna RAL 9006	5,95	<b>7,26</b>	5,95	<b>7,26</b>	5,75	<b>7,02</b>	5,75	<b>7,02</b>	5,75	<b>7,02</b>
	068033 *		068040 *		068057 *		068064 *		068071 *	
<b>TH</b> Tmavo hreda ČOKO RAL 8017	5,95	<b>7,26</b>	5,95	<b>7,26</b>	5,75	<b>7,02</b>	5,75	<b>7,02</b>		
	084583 *		084590 *		084606		084613 *			
<b>MH</b> Opečno rdeča RAL 8004	5,95	<b>7,26</b>	5,95	<b>7,26</b>	5,75	<b>7,02</b>	5,75	<b>7,02</b>	5,75	<b>7,02</b>
	085085 *		085092 *		085108 *		085115 *		085122 *	
Pakiranje v m	10		10		15		20		5	
Pakiranje v m	100		250		375		500		625	

\* Izdelava po meri

## CEV ODVODNA [s=0,50]

P-PZR

Nominalna velikost	80		100		100		100		100	
Dolžina v m	6,0		1,0		2,0		3,0		4,0	
Cena v €/m	Brez DDV		Brez DDV		Brez DDV		Brez DDV		Brez DDV	
<b>TM</b> Testa di Moro RAL 8028	5,75	<b>7,02</b>	6,50	<b>7,93</b>	6,50	<b>7,93</b>	6,30	<b>7,69</b>	6,30	<b>7,69</b>
	068583 *		068590 *		068606 *		068613		068620 *	
<b>AN</b> Antracit RAL 7016	5,10	<b>6,22</b>	5,75	<b>7,02</b>	5,75	<b>7,02</b>	5,55	<b>6,77</b>	5,55	<b>6,77</b>
	067913 *		067920 *		067937 *		067944		067951 *	
<b>IC</b> Črna intenzivno RAL 9005	5,75	<b>7,02</b>	6,50	<b>7,93</b>	6,50	<b>7,93</b>	6,30	<b>7,69</b>	6,30	<b>7,69</b>
	068262 *		068279 *		068286 *		068293		068309 *	
<b>OC</b> Vinsko rdeča RAL 3009	5,75	<b>7,02</b>	6,50	<b>7,93</b>	6,50	<b>7,93</b>	6,30	<b>7,69</b>	6,30	<b>7,69</b>
	068422 *		068439 *		068446 *		068453		068460 *	
<b>BH</b> Srebrna RAL 9006	5,75	<b>7,02</b>	6,50	<b>7,93</b>	6,50	<b>7,93</b>	6,30	<b>7,69</b>	6,30	<b>7,69</b>
	068088 *		068095 *		068101 *		068118 *		068125 *	
<b>TH</b> Tmavo hreda ČOKO RAL 8017			6,50	<b>7,93</b>	6,50	<b>7,93</b>	6,30	<b>7,69</b>	6,30	<b>7,69</b>
			084644 *		084651 *		084668		084675	
<b>MH</b> Opečno rdeča RAL 8004	5,75	<b>7,02</b>	6,50	<b>7,93</b>	6,50	<b>7,93</b>	6,30	<b>7,69</b>	6,30	<b>7,69</b>
	085139 *		085146 *		085153 *		085160 *		085177 *	
Pakiranje v m	6		10		10		15		20	
Pakiranje v m	750		70		160		240		320	

\* Izdelava po meri

# POCINKANO POLYESTER

## CEV ODVODNA [s=0,50]

P-PZR



Nominalna velikost	100		100		120		120		120		
Dolžina v m	5,0		6,0		1,0		2,0		3,0		
Cena v €/m	Brez DDV		Brez DDV		Brez DDV		Brez DDV		Brez DDV		
<b>TM</b> Testa di Moro RAL 8028	1	6,30	<b>7,69</b>	6,30	<b>7,69</b>	9,20	<b>11,22</b>	9,20	<b>11,22</b>	9,00	<b>10,98</b>
		068637 *		068644 *		068651 *		068668 *		068675	
<b>AN</b> Antracit RAL 7016	2	5,55	<b>6,77</b>	5,55	<b>6,77</b>	8,20	<b>10,00</b>	8,20	<b>10,00</b>	8,00	<b>9,76</b>
		067968 *		067975 *		067982 *		085023 *		067999	
<b>IC</b> Črna intenzivno RAL 9005	3	6,30	<b>7,69</b>	6,30	<b>7,69</b>	9,20	<b>11,22</b>	9,20	<b>11,22</b>	9,00	<b>10,98</b>
		068316 *		068323 *		085078 *		084910 *		068330	
<b>OC</b> Vinsko rdeča RAL 3009	4	6,30	<b>7,69</b>	6,30	<b>7,69</b>	9,20	<b>11,22</b>	9,20	<b>11,22</b>	9,00	<b>10,98</b>
		068477 *		068484 *		084927 *		084972 *		068491 *	
<b>BH</b> Srebrna RAL 9006	5	6,30	<b>7,69</b>	6,30	<b>7,69</b>	9,20	<b>11,22</b>	9,20	<b>11,22</b>	9,00	<b>10,98</b>
		068132 *		068149 *		068156 *		068163 *		068170 *	
<b>TH</b> Tmavo hredá ČOKO RAL 8017	6					9,20	<b>11,22</b>	9,20	<b>11,22</b>	9,00	<b>10,98</b>
						084705 *		084712 *		084729 *	
<b>MH</b> Opečno rdeča RAL 8004	9	6,30	<b>7,69</b>	6,30	<b>7,69</b>	9,20	<b>11,22</b>	9,20	<b>11,22</b>	9,00	<b>10,98</b>
		085184 *		085191 *		085207 *		085214 *		085221 *	
<b>Pakiranje v m</b>		<b>5</b>		<b>6</b>		<b>8</b>		<b>10</b>		<b>15</b>	
<b>Pakiranje v m</b>		<b>400</b>		<b>480</b>		<b>48</b>		<b>120</b>		<b>180</b>	

\* Izdelava po meri

## CEV ODVODNA [s=0,50]

P-PZR





Nominalna velikost	120		120		120		
Dolžina v m	4,0		5,0		6,0		
Cena v €/m	Brez DDV		Brez DDV		Brez DDV		
<b>TM</b> Testa di Moro RAL 8028	1	9,00	<b>10,98</b>	9,00	<b>10,98</b>	9,00	<b>10,98</b>
		068682 *		068699 *		068705 *	
<b>AN</b> Antracit RAL 7016	2	8,00	<b>9,76</b>	8,00	<b>9,76</b>	8,00	<b>9,76</b>
		068002 *		068019 *		068026 *	
<b>IC</b> Črna intenzivno RAL 9005	3	9,00	<b>10,98</b>	9,00	<b>10,98</b>	9,00	<b>10,98</b>
		068347 *		068354 *		068361 *	
<b>OC</b> Vinsko rdeča RAL 3009	4	9,00	<b>10,98</b>	9,00	<b>10,98</b>	9,00	<b>10,98</b>
		068507 *		068514 *		068521 *	
<b>BH</b> Srebrna RAL 9006	5	9,00	<b>10,98</b>	9,00	<b>10,98</b>	9,00	<b>10,98</b>
		068187 *		068194 *		068200 *	
<b>TH</b> Tmavo hredá ČOKO RAL 8017	6	9,00	<b>10,98</b>				
		084736 *					
<b>MH</b> Opečno rdeča RAL 8004	9	9,00	<b>10,98</b>	9,00	<b>10,98</b>	9,00	<b>10,98</b>
		085238 *		085245 *		085252 *	
<b>Pakiranje v m</b>		<b>20</b>		<b>5</b>		<b>6</b>	
<b>Pakiranje v m</b>		<b>240</b>		<b>300</b>		<b>360</b>	

\* Izdelava po meri

## SPOJ ZA CEV

## P-PSRU

Nominalna velikost	80		100		120	
	Brez DDV	Z DDV	Brez DDV	Z DDV	Brez DDV	Z DDV
<b>TM</b> 1 Testa di Moro RAL 8028	4,25	<b>5,19</b>	4,40	<b>5,37</b>	4,90	<b>5,98</b>
	017581		017598		017604	
<b>AN</b> 2 Antracit RAL 7016	4,25	<b>5,19</b>	4,40	<b>5,37</b>	4,90	<b>5,98</b>
	017284		017291		017307	
<b>IC</b> 3 Črna intenzivno RAL 9005	4,25	<b>5,19</b>	4,40	<b>5,37</b>	4,90	<b>5,98</b>
	017345		017352		017369	
<b>OC</b> 4 Vinsko rdeča RAL 3009	4,25	<b>5,19</b>	4,40	<b>5,37</b>	4,90	<b>5,98</b>
	017499		017505		017512	
<b>MH</b> 5 Opečno rdeča RAL 8004	4,25	<b>5,19</b>	4,40	<b>5,37</b>	4,90	<b>5,98</b>
	017376		017383		017390	
<b>SB</b> 6 Umazano bela RAL 9002	4,25	<b>5,19</b>	4,40	<b>5,37</b>	4,90	<b>5,98</b>
	017550		017567		017574	
<b>BH</b> 7 Srebrna RAL 9006	4,25	<b>5,19</b>	4,40	<b>5,37</b>	4,90	<b>5,98</b>
	017314		017321		017338	
<b>PS</b> 8 Prašno siva RAL 7037	4,25	<b>5,19</b>	4,40	<b>5,37</b>	4,90	<b>5,98</b>
	017529		017536		017543	
<b>MM</b> 9 Metalik bakrena RAL extra	4,25	<b>5,19</b>	4,40	<b>5,37</b>	4,90	<b>5,98</b>
	017406		017413		017420	
<b>BHT – P.20</b> 10 Temno srebrna RAL 9007	4,25	<b>5,19</b>	4,40	<b>5,37</b>	4,90	<b>5,98</b>
	095657 *		095664		095671 *	
<b>MZ</b> 11 Zelena mahovo RAL 6005	4,25	<b>5,19</b>	4,40	<b>5,37</b>	4,90	<b>5,98</b>
	017468 *		017475		017482	
<b>MOT</b> 12 Temno modra RAL 5010	4,25	<b>5,19</b>	4,40	<b>5,37</b>	4,90	<b>5,98</b>
	017437 *		017444		017451	
<b>TZ</b> 13 Zelena svetlo RAL 6011	4,25	<b>5,19</b>	4,40	<b>5,37</b>	4,90	<b>5,98</b>
	017611 *		017628		017635 *	
<b>Pakiranje v kos</b> 	<b>10</b>		<b>10</b>		<b>8</b>	
<b>Pakiranje v kos</b> 	<b>900</b>		<b>900</b>		<b>720</b>	

\* Izdelava po meri





## ODTOČNO KOLENO ODSKOKOVÉ

P-PKO



Nominalna velikost	80		100		120	
	Brez DDV	Z DDV	Brez DDV	Z DDV	Brez DDV	Z DDV
<b>TM</b> 1 Testa di Moro RAL 8028	9,40	<b>11,47</b>	9,70	<b>11,83</b>	13,95	<b>17,02</b>
	034045		034052		034069	
<b>AN</b> 2 Antracit RAL 7016	9,40	<b>11,47</b>	9,70	<b>11,83</b>	13,95	<b>17,02</b>
	033741		033758		033765	
<b>IC</b> 3 Črna intenzivno RAL 9005	9,40	<b>11,47</b>	9,70	<b>11,83</b>	13,95	<b>17,02</b>
	033802		033819		033826	
<b>OC</b> 4 Vinsko rdeča RAL 3009	9,40	<b>11,47</b>	9,70	<b>11,83</b>	13,95	<b>17,02</b>
	033956		033963		033970	
<b>MH</b> 5 Opečno rdeča RAL 8004	9,40	<b>11,47</b>	9,70	<b>11,83</b>	13,95	<b>17,02</b>
	033833		033840		033857	
<b>SB</b> 6 Umazano bela RAL 9002	9,40	<b>11,47</b>	9,70	<b>11,83</b>	13,95	<b>17,02</b>
	034014		034021		034038	
<b>BH</b> 7 Srebrna RAL 9006	9,40	<b>11,47</b>	9,70	<b>11,83</b>	13,95	<b>17,02</b>
	033772		033789		033796	
<b>PS</b> 8 Prašno siva RAL 7037	9,40	<b>11,47</b>	9,70	<b>11,83</b>	13,95	<b>17,02</b>
	033987		033994		034007	
<b>MM</b> 9 Metalik bakrena RAL extra	9,40	<b>11,47</b>	9,70	<b>11,83</b>	13,95	<b>17,02</b>
	033864		033871		033888	
<b>BHT – P.20</b> 10 Temno srebrna RAL 9007	9,40	<b>11,47</b>	9,70	<b>11,83</b>	13,95	<b>17,02</b>
	095688		095695		095701	
<b>MZ</b> 11 Zelena mahovo RAL 6005	9,40	<b>11,47</b>	9,70	<b>11,83</b>	13,95	<b>17,02</b>
	033925		033932		033949	
<b>MOT</b> 12 Temno modra RAL 5010	9,40	<b>11,47</b>	9,70	<b>11,83</b>	13,95	<b>17,02</b>
	033895		033901		033918	
<b>TZ</b> 13 Zelena svetlo RAL 6011	9,40	<b>11,47</b>	9,70	<b>11,83</b>	13,95	<b>17,02</b>
	034076		034083		034090	
<b>Pakiranje v kos</b>	<b>20</b>		<b>20</b>		<b>15</b>	
<b>Pakiranje v kos</b>	<b>320</b>		<b>240</b>		<b>180</b>	

## REDUKCIJA CEVI 72°

P-PZO

Nominalna velikost	80/80		100/60		100/80		100/100	
	Brez DDV	Z DDV	Brez DDV	Z DDV	Brez DDV	Z DDV	Brez DDV	Z DDV
<b>TM</b> 1 Testa di Moro RAL 8028	15,65	<b>19,09</b>	17,40	<b>21,23</b>	17,40	<b>21,23</b>	18,00	<b>21,96</b>
	016157		016164		016171		016188	
<b>AN</b> 2 Antracit RAL 7016	15,65	<b>19,09</b>	17,40	<b>21,23</b>	17,40	<b>21,23</b>	18,00	<b>21,96</b>
	015259		015266		015273		015280	
<b>IC</b> 3 Črna intenzivno RAL 9005	15,65	<b>19,09</b>	17,40	<b>21,23</b>	17,40	<b>21,23</b>	18,00	<b>21,96</b>
	015433		015440		015457		015464	
<b>OC</b> 4 Vinsko rdeča RAL 3009	15,65	<b>19,09</b>	17,40	<b>21,23</b>	17,40	<b>21,23</b>	18,00	<b>21,96</b>
	015884		015891		015907		015914	
<b>MH</b> 5 Opečno rdeča RAL 8004	15,65	<b>19,09</b>	17,40	<b>21,23</b>	17,40	<b>21,23</b>	18,00	<b>21,96</b>
	015525		015532 *		015549		015556	
<b>SB</b> 6 Umazano bela RAL 9002	15,65	<b>19,09</b>	17,40	<b>21,23</b>	17,40	<b>21,23</b>	18,00	<b>21,96</b>
	016065		016072 *		016089		016096	
<b>BH</b> 7 Srebrna RAL 9006	15,65	<b>19,09</b>	17,40	<b>21,23</b>	17,40	<b>21,23</b>	18,00	<b>21,96</b>
	015341		015358 *		015365		015372	
<b>PS</b> 8 Prašno siva RAL 7037	15,65	<b>19,09</b>	17,40	<b>21,23</b>	17,40	<b>21,23</b>	18,00	<b>21,96</b>
	015976 *		015983 *		015990		016003	
<b>MM</b> 9 Metalik bakrena RAL extra	15,65	<b>19,09</b>	17,40	<b>21,23</b>	17,40	<b>21,23</b>	18,00	<b>21,96</b>
	015617		015624 *		015631		015648	
<b>BHT – P.20</b> 10 Temno srebrna RAL 9007	15,65	<b>19,09</b>			17,40	<b>21,23</b>	18,00	<b>21,96</b>
	096005 *				096012 *		096029 *	
<b>MZ</b> 11 Zelena mahovo RAL 6005	15,65	<b>19,09</b>	17,40	<b>21,23</b>	17,40	<b>21,23</b>	18,00	<b>21,96</b>
	015792		015808 *		015815		015822	
<b>MOT</b> 12 Temno modra RAL 5010	15,65	<b>19,09</b>	17,40	<b>21,23</b>	17,40	<b>21,23</b>	18,00	<b>21,96</b>
	015709 *		015716 *		015723 *		015730	
<b>TZ</b> 13 Zelena svetlo RAL 6011	15,65	<b>19,09</b>	17,40	<b>21,23</b>	17,40	<b>21,23</b>	18,00	<b>21,96</b>
	016249 *		016256 *		016263 *		016270 *	
<b>Pakiranje v kos</b> 	<b>4</b>		<b>4</b>		<b>4</b>		<b>4</b>	
<b>Pakiranje v kos</b> 	<b>120</b>		<b>120</b>		<b>120</b>		<b>120</b>	

\* Izdelava po meri



## REDUKCIJA CEVI 72°

P-PZO



Nominalna velikost	120/80		120/100		120/120		150/120		150/150	
	Brez DDV	Z DDV	Brez DDV	Z DDV	Brez DDV	Z DDV	Brez DDV	Z DDV	Brez DDV	Z DDV
<b>TM</b> 1 Testa di Moro RAL 8028	19,80	<b>24,16</b>	19,80	<b>24,16</b>	19,80	<b>24,16</b>	28,80	<b>35,14</b>	28,80	<b>35,14</b>
	016195		016201		016218		016225 *		016232 *	
<b>AN</b> 2 Antracit RAL 7016	19,80	<b>24,16</b>	19,80	<b>24,16</b>	19,80	<b>24,16</b>	28,80	<b>35,14</b>	28,80	<b>35,14</b>
	015297		015303		015310		015327 *		015334 *	
<b>IC</b> 3 Črna intenzivno RAL 9005	19,80	<b>24,16</b>	19,80	<b>24,16</b>	19,80	<b>24,16</b>	28,80	<b>35,14</b>	28,80	<b>35,14</b>
	015471		015488		015495		015501 *		015518 *	
<b>OC</b> 4 Vinsko rdeča RAL 3009	19,80	<b>24,16</b>	19,80	<b>24,16</b>	19,80	<b>24,16</b>	28,80	<b>35,14</b>	28,80	<b>35,14</b>
	015921		015938		015945		015952 *		015969 *	
<b>MH</b> 5 Opečno rdeča RAL 8004	19,80	<b>24,16</b>	19,80	<b>24,16</b>	19,80	<b>24,16</b>	28,80	<b>35,14</b>	28,80	<b>35,14</b>
	015563		015570		015587		015594 *		015600 *	
<b>SB</b> 6 Umazano bela RAL 9002	19,80	<b>24,16</b>	19,80	<b>24,16</b>	19,80	<b>24,16</b>	28,80	<b>35,14</b>	28,80	<b>35,14</b>
	016102		016119		016126		016133 *		016140 *	
<b>BH</b> 7 Srebrna RAL 9006	19,80	<b>24,16</b>	19,80	<b>24,16</b>	19,80	<b>24,16</b>	28,80	<b>35,14</b>	28,80	<b>35,14</b>
	015389		015396		015402		015419 *		015426 *	
<b>PS</b> 8 Prašno siva RAL 7037	19,80	<b>24,16</b>	19,80	<b>24,16</b>	19,80	<b>24,16</b>	28,80	<b>35,14</b>	28,80	<b>35,14</b>
	016010 *		016027		016034		016041 *		016058 *	
<b>MM</b> 9 Metalik bakrena RAL extra	19,80	<b>24,16</b>	19,80	<b>24,16</b>	19,80	<b>24,16</b>	28,80	<b>35,14</b>	28,80	<b>35,14</b>
	015655 *		015662		015679		015686 *		015693 *	
<b>BHT – P.20</b> 10 Temno srebrna RAL 9007	19,80	<b>24,16</b>	19,80	<b>24,16</b>	19,80	<b>24,16</b>				
	096036 *		096043 *		096050 *					
<b>MZ</b> 11 Zelena mahovo RAL 6005	19,80	<b>24,16</b>	19,80	<b>24,16</b>	19,80	<b>24,16</b>	28,80	<b>35,14</b>	28,80	<b>35,14</b>
	015839 *		015846 *		015853 *		015860 *		015877 *	
<b>MOT</b> 12 Temno modra RAL 5010	19,80	<b>24,16</b>	19,80	<b>24,16</b>	19,80	<b>24,16</b>	28,80	<b>35,14</b>	28,80	<b>35,14</b>
	015747 *		015754 *		015761 *		015778 *		015785 *	
<b>TZ</b> 13 Zelena svetlo RAL 6011	19,80	<b>24,16</b>	19,80	<b>24,16</b>	19,80	<b>24,16</b>	28,80	<b>35,14</b>	28,80	<b>35,14</b>
	016287 *		016294 *		016300 *		016317 *		016324 *	
<b>Pakiranje v kos</b>	<b>3</b>		<b>3</b>		<b>3</b>		<b>2</b>		<b>2</b>	
<b>Pakiranje v kos</b>	<b>90</b>		<b>90</b>		<b>90</b>		<b>36</b>		<b>36</b>	

\* Izdelava po meri

## ODTOČNI RAZDELILNIK VODE

P-PRV

Nominalna velikost	80		100		120	
	Brez DDV	Z DDV	Brez DDV	Z DDV	Brez DDV	Z DDV
<b>TM</b> 1 Testa di Moro RAL 8028	195,00	<b>237,90</b>	199,90	<b>243,88</b>	259,00	<b>315,98</b>
	088413 *		088420		088437 *	
<b>AN</b> 2 Antracit RAL 7016	195,00	<b>237,90</b>	199,90	<b>243,88</b>	259,00	<b>315,98</b>
	088116 *		088123		088130 *	
<b>IC</b> 3 Črna intenzivno RAL 9005	195,00	<b>237,90</b>	199,90	<b>243,88</b>	259,00	<b>315,98</b>
	088178 *		088185 *		088192 *	
<b>OC</b> 4 Vinsko rdeča RAL 3009	195,00	<b>237,90</b>	199,90	<b>243,88</b>	259,00	<b>315,98</b>
	088321 *		088338 *		088345 *	
<b>MH</b> 5 Opečno rdeča RAL 8004	195,00	<b>237,90</b>	199,90	<b>243,88</b>	259,00	<b>315,98</b>
	088208 *		088215 *		088222 *	
<b>SB</b> 6 Umazano bela RAL 9002	195,00	<b>237,90</b>	199,90	<b>243,88</b>	259,00	<b>315,98</b>
	088383 *		088390 *		088406 *	
<b>BH</b> 7 Srebrna RAL 9006	195,00	<b>237,90</b>	199,90	<b>243,88</b>	259,00	<b>315,98</b>
	088147 *		088154 *		088161 *	
<b>PS</b> 8 Prašno siva RAL 7037	195,00	<b>237,90</b>	199,90	<b>243,88</b>	259,00	<b>315,98</b>
	088352 *		088369 *		088376 *	
<b>MM</b> 9 Metalik bakrena RAL extra	195,00	<b>237,90</b>	199,90	<b>243,88</b>	259,00	<b>315,98</b>
	088239 *		088246 *		088253 *	
<b>BHT – P.20</b> 10 Temno srebrna RAL 9007	195,00	<b>237,90</b>	199,90	<b>243,88</b>	259,00	<b>315,98</b>
	095756 *		095763 *		095770 *	
<b>MZ</b> 11 Zelena mahovo RAL 6005	195,00	<b>237,90</b>	199,90	<b>243,88</b>	259,00	<b>315,98</b>
	088291 *		088307 *		088314 *	
<b>MOT</b> 12 Temno modra RAL 5010	195,00	<b>237,90</b>	199,90	<b>243,88</b>	259,00	<b>315,98</b>
	088260 *		088277 *		088284 *	
<b>TZ</b> 13 Zelena svetlo RAL 6011	195,00	<b>237,90</b>	199,90	<b>243,88</b>	259,00	<b>315,98</b>
	088444 *		088451 *		088468 *	
<b>Pakiranje v kos</b> 	1		1		1	
<b>Pakiranje v kos</b> 	-		-		-	

\* Izdelava po meri

POCINKANO  
POLYESTER



## OBJEMKA Z ŽEBLJEM 150 mm

P-PO

Nominalna velikost	80		100		120	
	Brez DDV	Z DDV	Brez DDV	Z DDV	Brez DDV	Z DDV
<b>TM</b> 1 Testa di Moro RAL 8028	3,30	<b>4,03</b>	3,35	<b>4,09</b>	4,00	<b>4,88</b>
	002136		002143		002150	
<b>AN</b> 2 Antracit RAL 7016	3,30	<b>4,03</b>	3,35	<b>4,09</b>	4,00	<b>4,88</b>
	001986		001993		002006	
<b>IC</b> 3 Črna intenzivno RAL 9005	3,30	<b>4,03</b>	3,35	<b>4,09</b>	4,00	<b>4,88</b>
	002013		002020		002037	
<b>OC</b> 4 Vinsko rdeča RAL 3009	3,30	<b>4,03</b>	3,35	<b>4,09</b>	4,00	<b>4,88</b>
	002075		002082		002099	
<b>MH</b> 5 Opečno rdeča RAL 8004	3,30	<b>4,03</b>	3,35	<b>4,09</b>	4,00	<b>4,88</b>
	002044		002051		002068	
<b>SB</b> 6 Umazano bela RAL 9002	3,30	<b>4,03</b>	3,35	<b>4,09</b>	4,00	<b>4,88</b>
	002105		002112		002129	
<b>Pakiranje v kos</b> 📦	<b>25</b>		<b>25</b>		<b>25</b>	
<b>Pakiranje v kos</b> 🚚	<b>1 000</b>		<b>1 000</b>		<b>1 000</b>	



## OBJEMKA Z ŽEBLJEM 200 mm



P-POD

Nominalna velikost	80		100		120	
	Brez DDV	Z DDV	Brez DDV	Z DDV	Brez DDV	Z DDV
<b>TM</b> 1 Testa di Moro RAL 8028	3,50	<b>4,27</b>	3,50	<b>4,27</b>	4,05	<b>4,94</b>
	001955		001962		001979	
<b>AN</b> 2 Antracit RAL 7016	3,50	<b>4,27</b>	3,50	<b>4,27</b>	4,05	<b>4,94</b>
	001801		001818		001825	
<b>IC</b> 3 Črna intenzivno RAL 9005	3,50	<b>4,27</b>	3,50	<b>4,27</b>	4,05	<b>4,94</b>
	001832		001849		001856	
<b>OC</b> 4 Vinsko rdeča RAL 3009	3,50	<b>4,27</b>	3,50	<b>4,27</b>	4,05	<b>4,94</b>
	001894		001900		001917	
<b>MH</b> 5 Opečno rdeča RAL 8004	3,50	<b>4,27</b>	3,50	<b>4,27</b>	4,05	<b>4,94</b>
	001863		001870		001887	
<b>SB</b> 6 Umazano bela RAL 9002	3,50	<b>4,27</b>	3,50	<b>4,27</b>	4,05	<b>4,94</b>
	001924		001931		001948	
<b>Pakiranje v kos</b> 📦	<b>25</b>		<b>25</b>		<b>25</b>	
<b>Pakiranje v kos</b> 🚚	<b>1 000</b>		<b>1 000</b>		<b>1 000</b>	



## OBJEMKA Z ŽEBLJEM 300 mm

P-PODD

Nominalna velikost	100		120	
	Brez DDV	Z DDV	Brez DDV	Z DDV
<b>TM</b> 1 Testa di Moro RAL 8028	4,55	<b>5,55</b>	4,95	<b>6,04</b>
	002402		002419	
<b>AN</b> 2 Antracit RAL 7016	4,55	<b>5,55</b>	4,95	<b>6,04</b>
	002303		002310	
<b>IC</b> 3 Črna intenzivno RAL 9005	4,55	<b>5,55</b>	4,95	<b>6,04</b>
	002327		002334	
<b>OC</b> 4 Vinsko rdeča RAL 3009	4,55	<b>5,55</b>	4,95	<b>6,04</b>
	002365		002372	
<b>MH</b> 5 Opečno rdeča RAL 8004	4,55	<b>5,55</b>	4,95	<b>6,04</b>
	002341		002358	
<b>SB</b> 6 Umazano bela RAL 9002	4,55	<b>5,55</b>	4,95	<b>6,04</b>
	002389		002396	
<b>Pakiranje v kos</b> 	<b>20</b>		<b>20</b>	
<b>Pakiranje v kos</b> 	<b>800</b>		<b>800</b>	





POCINKANO  
POLYESTER



## OBJEMKA Z NAVOJEM M10

## P-POB

Nominalna velikost	60		80		100		120		150	
	Brez DDV	Z DDV	Brez DDV	Z DDV	Brez DDV	Z DDV	Brez DDV	Z DDV	Brez DDV	Z DDV
<b>TM</b> 1 Testa di Moro RAL 8028	2,90	<b>3,54</b>	2,65	<b>3,23</b>	2,75	<b>3,36</b>	3,30	<b>4,03</b>	4,90	<b>5,98</b>
	074119		074126		074133		074140		074157	
<b>AN</b> 2 Antracit RAL 7016	2,90	<b>3,54</b>	2,65	<b>3,23</b>	2,75	<b>3,36</b>	3,30	<b>4,03</b>	4,90	<b>5,98</b>
	073471		073488		073495		073501		073518	
<b>IC</b> 3 Črna intenzivno RAL 9005	2,90	<b>3,54</b>	2,65	<b>3,23</b>	2,75	<b>3,36</b>	3,30	<b>4,03</b>	4,90	<b>5,98</b>
	073679		073686		073693		073709		073716	
<b>OC</b> 4 Vinsko rdeča RAL 3009	2,90	<b>3,54</b>	2,65	<b>3,23</b>	2,75	<b>3,36</b>	3,30	<b>4,03</b>	4,90	<b>5,98</b>
	073914		073921		073938		073945		073952	
<b>MH</b> 5 Opečno rdeča RAL 8004	2,90	<b>3,54</b>	2,65	<b>3,23</b>	2,75	<b>3,36</b>	3,30	<b>4,03</b>	4,90	<b>5,98</b>
	073723		073730		073747		073754		073761	
<b>SB</b> 6 Umazano bela RAL 9002	2,90	<b>3,54</b>	2,65	<b>3,23</b>	2,75	<b>3,36</b>	3,30	<b>4,03</b>	4,90	<b>5,98</b>
	074010		074027		074034		074041		074058	
<b>BH</b> 7 Srebrna RAL 9006	2,90	<b>3,54</b>	2,65	<b>3,23</b>	2,75	<b>3,36</b>	3,30	<b>4,03</b>	4,90	<b>5,98</b>
	073570		073587		073594		073600		073617	
<b>PS</b> 8 Prašno siva RAL 7037	2,90	<b>3,54</b>	2,65	<b>3,23</b>	2,75	<b>3,36</b>	3,30	<b>4,03</b>	4,90	<b>5,98</b>
	073969		073976		073983		073990		074003	
<b>MM</b> 9 Metalik bakrena RAL extra	2,90	<b>3,54</b>	2,65	<b>3,23</b>	2,75	<b>3,36</b>	3,30	<b>4,03</b>	4,90	<b>5,98</b>
	073778		073785		073792		073808		077158	
<b>BHT – P.20</b> 10 Temno srebrna RAL 9007	2,90	<b>3,54</b>	2,65	<b>3,23</b>	2,75	<b>3,36</b>	3,30	<b>4,03</b>	4,90	<b>5,98</b>
	119711		094537		094544		094551		094674	
<b>MZ</b> 11 Zelena mahovo RAL 6005	2,90	<b>3,54</b>	2,65	<b>3,23</b>	2,75	<b>3,36</b>	3,30	<b>4,03</b>	4,90	<b>5,98</b>
	073860		073877		073884		073891		073907	
<b>MOT</b> 12 Temno modra RAL 5010	2,90	<b>3,54</b>	2,65	<b>3,23</b>	2,75	<b>3,36</b>	3,30	<b>4,03</b>	4,90	<b>5,98</b>
	073815		073822		073839		073846		073853	
<b>TZ</b> 13 Zelena svetlo RAL 6011	2,90	<b>3,54</b>	2,65	<b>3,23</b>	2,75	<b>3,36</b>	3,30	<b>4,03</b>	4,90	<b>5,98</b>
	074164 *		074171		074188		074195		074201 *	
<b>Pakiranje v kos</b> 	<b>25</b>		<b>25</b>		<b>25</b>		<b>25</b>		<b>20</b>	
<b>Pakiranje v kos</b> 	<b>3 000</b>		<b>3 000</b>		<b>3 000</b>		<b>3 000</b>		<b>2 400</b>	

\* Izdelava po meri



## OBJEMKA Z NAVOJEM M8

P-POB



Nominalna velikost	60		80		100		120		150	
	Brez DDV	Z DDV	Brez DDV	Z DDV	Brez DDV	Z DDV	Brez DDV	Z DDV	Brez DDV	Z DDV
<b>TM</b> 1 Testa di Moro RAL 8028	2,90	<b>3,54</b>	2,65	<b>3,23</b>	2,75	<b>3,36</b>	3,30	<b>4,03</b>	4,90	<b>5,98</b>
	074065		074072		074089		074096		074102	
<b>AN</b> 2 Antracit RAL 7016	2,90	<b>3,54</b>	2,65	<b>3,23</b>	2,75	<b>3,36</b>	3,30	<b>4,03</b>	4,90	<b>5,98</b>
	073426		073433		073440		073457		073464	
<b>IC</b> 3 Črna intenzivno RAL 9005	2,90	<b>3,54</b>	2,65	<b>3,23</b>	2,75	<b>3,36</b>	3,30	<b>4,03</b>	4,90	<b>5,98</b>
	073624		073631		073648		073655		073662	
<b>BH</b> 7 Srebrna RAL 9006	2,90	<b>3,54</b>	2,65	<b>3,23</b>	2,75	<b>3,36</b>	3,30	<b>4,03</b>	4,90	<b>5,98</b>
	073532		073525		073549		073556		073563	
Pakiranje v kos	25		25		25		25		20	
Pakiranje v kos	3 000		3 000		3 000		3 000		2 400	





## INOX VIJAK ZA OBJEMKO M6x20

## P-POB-NSK



Nominalna velikost	EAN številko izdelka	Pakiranje v kos		Cena [€/kos]	
				Brez DDV	Z DDV
<b>M6 x 20 *</b>	071675	1	–	0,15	<b>0,18</b>

\* Izdelava po meri

## VIJAK ZA OBJEMKO TORX M10

## P-POB-HT



Nominalna velikost	EAN številko izdelka	Pakiranje v kos		Cena [€/kos]	
				Brez DDV	Z DDV
<b>80</b>	002464	100	40 000	1,00	<b>1,22</b>
<b>140</b>	002471	100	28 000	1,25	<b>1,53</b>
<b>200</b>	002488	100	20 000	1,55	<b>1,89</b>
<b>250</b>	002495	100	16 000	1,70	<b>2,07</b>
<b>300</b>	002501	100	11 200	1,70	<b>2,07</b>

## VLOŽEK M10

## P-POB-HN DB



Nominalna velikost	EAN številko izdelka	Pakiranje v kos		Cena [€/kos]	
				Brez DDV	Z DDV
<b>120</b>	002426	100	25 000	0,40	<b>0,49</b>

## VLOŽEK Z LAMELO M10

## P-POB-HN DB



Nominalna velikost	EAN številko izdelka	Pakiranje v kos		Cena [€/kos]	
				Brez DDV	Z DDV
<b>180</b>	002433	100	12 000	0,42	<b>0,51</b>
<b>240</b>	002440	100	12 000	0,50	<b>0,61</b>
<b>280</b>	002457	100	12 000	0,53	<b>0,65</b>

## KOMBINIRANI VIJAK TORX M10

## P-POB-ZT/SZ



Nominalna velikost	EAN številko izdelka	Pakiranje v kos		Cena [€/kos]	
				Brez DDV	Z DDV
<b>140</b>	002587	50	10 400	0,45	<b>0,55</b>
<b>180</b>	002594	50	10 400	0,55	<b>0,67</b>

# POCINKANO POLYESTER

## VLOŽEK ZA OBJEMKU 7x7

P-POB-HN R1



Nominalna velikost	EAN številko izdelka	Pakiranje v kos		Cena [€/kos]	
				Brez DDV	Z DDV
200/60	002600	250	15 000	0,17	0,21

## VLOŽEK ZA IZOLACIJO M10

P-POB-HN IZOL



Nominalna velikost	EAN številko izdelka	Pakiranje v kos		Cena [€/kos]	
				Brez DDV	Z DDV
M10 x 96	001207	25	2 625	2,70	3,29

## IZOLACIJSKI ZATIČ KONICA ZIDAK BREZ TOPLLOTNE IZOLACIJE

P-POB-HN WDVS140 M10



Nominalna velikost	EAN številko izdelka	Pakiranje v kos		Cena [€/kos]	
				Brez DDV	Z DDV
140	144843	1/5	750	4,80	5,86

## IZOLACIJSKI ZATIČ KONICA ZIDAK S TOPLLOTNO IZOLACIJO

P-POB-HN WDVS300 M10



Nominalna velikost	EAN številko izdelka	Pakiranje v kos		Cena [€/kos]	
				Brez DDV	Z DDV
300	144850	1/5	500	7,80	9,52

## NERJAVNA UNI PLATFORMA ZA PRITRJEVANJE OB M10

P-POB-HN PLAT M10



Nominalna velikost	EAN številko izdelka	Pakiranje v kos		Cena [€/kos]	
				Brez DDV	Z DDV
M10	144836	25/500	5 000	3,35	4,09

## NAVOJNA PALICA M10

P-POB-ZT



Nominalna velikost	EAN številko izdelka	Pakiranje v kos		Cena [€/kos]	
				Brez DDV	Z DDV
60	002556	100	20 800	0,20	0,24
100	002563	100	15 600	0,30	0,37
150	002570	50	10 400	0,55	0,67

## PRITRDILNA PLOŠČA M10

## P-POB-ZT MP



Nominalna velikost	EAN številko izdelka	Pakiranje v kos		Cena [€/kos]	
				Brez DDV	Z DDV
<b>80 x 30</b>	002518	25	5 200	1,15	<b>1,40</b>

## VIJAK ZA OBJEMKO M8

## P-POB-HB



Nominalna velikost	EAN številko izdelka	Pakiranje v kos		Cena [€/kos]	
				Brez DDV	Z DDV
<b>150</b>	071590	100	5 000	0,65	<b>0,79</b>
<b>200</b>	071606	100	5 000	0,92	<b>1,12</b>
<b>250</b>	071613	100	5 000	1,05	<b>1,28</b>
<b>300</b>	071620	100	5 000	1,10	<b>1,34</b>

## VLOŽEK M8

## P-POB-HBN-SS



Nominalna velikost	EAN številko izdelka	Pakiranje v kos		Cena [€/kos]	
				Brez DDV	Z DDV
<b>150</b>	071637	100	5 000	0,25	<b>0,31</b>
<b>200</b>	071644	100	5 000	0,26	<b>0,32</b>
<b>250</b>	071651	100	5 000	0,35	<b>0,43</b>
<b>300</b>	071668	100	8 000	0,37	<b>0,45</b>

## ZAŠČITNI POKROV OBJEMKE

## P-POB-HT AKG



Nominalna velikost	EAN številko izdelka	Pakiranje v kos		Cena [€/kos]	
				Brez DDV	Z DDV
<b>29 x 13</b>	002280	50	16 800	0,25	<b>0,31</b>
<b>29 x 13</b>	002211	50	16 800	0,25	<b>0,31</b>
<b>29 x 13</b>	002235	50	16 800	0,25	<b>0,31</b>
<b>29 x 13</b>	002266	50	16 800	0,25	<b>0,31</b>
<b>29 x 13</b>	002242	50	16 800	0,25	<b>0,31</b>
<b>29 x 13</b>	002228	50	16 800	0,25	<b>0,31</b>
<b>29 x 13</b>	002273	50	16 800	0,25	<b>0,31</b>
<b>29 x 13</b>	002259	50	16 800	0,25	<b>0,31</b>
<b>29 x 13</b>	002297	50	16 800	0,25	<b>0,31</b>

## LOVILEC VODE

P-PZV



Nominalna velikost	80		100		120	
	Brez DDV	Z DDV	Brez DDV	Z DDV	Brez DDV	Z DDV
<b>TM</b> 1 Testa di Moro RAL 8028	12,55	<b>15,31</b>	12,95	<b>15,80</b>	19,00	<b>23,18</b>
	034533		034540		034557	
<b>AN</b> 2 Antracit RAL 7016	12,55	<b>15,31</b>	12,95	<b>15,80</b>	19,00	<b>23,18</b>
	034410		034427		034434	
<b>IC</b> 3 Črna intenzivno RAL 9005	12,55	<b>15,31</b>	12,95	<b>15,80</b>	19,00	<b>23,18</b>
	034441		034458		034465	
<b>OC</b> 4 Vinsko rdeča RAL 3009	12,55	<b>15,31</b>	12,95	<b>15,80</b>	19,00	<b>23,18</b>
	034502		034519		034526	
<b>MH</b> 5 Opečno rdeča RAL 8004	12,55	<b>15,31</b>	12,95	<b>15,80</b>	19,00	<b>23,18</b>
	034472		034489		034496	
<b>Pakiranje v kos</b>	<b>6</b>		<b>5</b>		<b>3</b>	
<b>Pakiranje v kos</b>	<b>180</b>		<b>150</b>		<b>90</b>	

## LOVILEC VODE S SITOM

## P-PZVS



Nominalna velikost	80		100		120	
	Brez DDV	Z DDV	Brez DDV	Z DDV	Brez DDV	Z DDV
<b>TM</b> 1 Testa di Moro RAL 8028	12,55	<b>15,31</b>	12,95	<b>15,80</b>	19,00	<b>23,18</b>
	034861		034878		034885	
<b>AN</b> 2 Antracit RAL 7016	12,55	<b>15,31</b>	12,95	<b>15,80</b>	19,00	<b>23,18</b>
	034564		034571		034588	
<b>IC</b> 3 Črna intenzivno RAL 9005	12,55	<b>15,31</b>	12,95	<b>15,80</b>	19,00	<b>23,18</b>
	034625		034632		034649	
<b>OC</b> 4 Vinsko rdeča RAL 3009	12,55	<b>15,31</b>	12,95	<b>15,80</b>	19,00	<b>23,18</b>
	034779		034786		034793	
<b>MH</b> 5 Opečno rdeča RAL 8004	12,55	<b>15,31</b>	12,95	<b>15,80</b>	19,00	<b>23,18</b>
	034656		034663		034670	
<b>SB</b> 6 Umazano bela RAL 9002	12,55	<b>15,31</b>	12,95	<b>15,80</b>	19,00	<b>23,18</b>
	034830		034847		034854	
<b>BH</b> 7 Srebrna RAL 9006	12,55	<b>15,31</b>	12,95	<b>15,80</b>	19,00	<b>23,18</b>
	034595		034601		034618	
<b>PS</b> 8 Prašno siva RAL 7037	12,55	<b>15,31</b>	12,95	<b>15,80</b>	19,00	<b>23,18</b>
	034809		034816		034823	
<b>MM</b> 9 Metalik bakrena RAL extra	12,55	<b>15,31</b>	12,95	<b>15,80</b>	19,00	<b>23,18</b>
	034687		034694		034700	
<b>BHT – P.20</b> 10 Temno srebrna RAL 9007	12,55	<b>15,31</b>	12,95	<b>15,80</b>	19,00	<b>23,18</b>
	095718		095725		095732	
<b>MZ</b> 11 Zelena mahovo RAL 6005	12,55	<b>15,31</b>	12,95	<b>15,80</b>	19,00	<b>23,18</b>
	034748		034755		034762	
<b>MOT</b> 12 Temno modra RAL 5010	12,55	<b>15,31</b>	12,95	<b>15,80</b>	19,00	<b>23,18</b>
	034717		034724		034731	
<b>TZ</b> 13 Zelena svetlo RAL 6011	12,55	<b>15,31</b>	12,95	<b>15,80</b>	19,00	<b>23,18</b>
	034892 *		034908		034915	
<b>Pakiranje v kos</b>	<b>6</b>		<b>5</b>		<b>3</b>	
<b>Pakiranje v kos</b>	<b>180</b>		<b>150</b>		<b>90</b>	

\* Izdelava po meri

## ALUMINIJ LOVILEC VODE S CEVJO

## P-PZVHA



Nominalna velikost	80		120	
	Brez DDV	Z DDV	Brez DDV	Z DDV
<b>TM</b> 1 Testa di Moro RAL 8028	65,00	<b>79,30</b>	125,00	<b>152,50</b>
	018793		018816	
<b>AN</b> 2 Antracit RAL 7016	65,00	<b>79,30</b>	125,00	<b>152,50</b>
	018496		018519	
<b>IC</b> 3 Črna intenzivno RAL 9005	65,00	<b>79,30</b>	125,00	<b>152,50</b>
	018557		018571	
<b>OC</b> 4 Vinsko rdeča RAL 3009	65,00	<b>79,30</b>	125,00	<b>152,50</b>
	018700		018724 *	
<b>MH</b> 5 Opečno rdeča RAL 8004	65,00	<b>79,30</b>	125,00	<b>152,50</b>
	018588 *		018601 *	
<b>SB</b> 6 Umazano bela RAL 9002	65,00	<b>79,30</b>	125,00	<b>152,50</b>
	018762 *		018786	
<b>BH</b> 7 Srebrna RAL 9006	65,00	<b>79,30</b>	125,00	<b>152,50</b>
	018526		018540	
<b>PS</b> 8 Prašno siva RAL 7037	65,00	<b>79,30</b>	125,00	<b>152,50</b>
	018731 *		018755 *	
<b>MM</b> 9 Metalik bakrena RAL extra	65,00	<b>79,30</b>	125,00	<b>152,50</b>
	018618 *		018632 *	
<b>BHT – P.20</b> 10 Temno srebrna RAL 9007	65,00	<b>79,30</b>	125,00	<b>152,50</b>
	095527 *		095541 *	
<b>MZ</b> 11 Zelena mahovo RAL 6005	65,00	<b>79,30</b>	125,00	<b>152,50</b>
	018670 *		018694 *	
<b>MOT</b> 12 Temno modra RAL 5010	65,00	<b>79,30</b>	125,00	<b>152,50</b>
	018649 *		018663 *	
<b>TZ</b> 13 Zelena svetlo RAL 6011	65,00	<b>79,30</b>	125,00	<b>152,50</b>
	018823 *		018847 *	
<b>Pakiranje v kos</b> 		<b>1</b>		<b>1</b>
<b>Pakiranje v kos</b> 		<b>60</b>		<b>60</b>

\* Izdelava po meri



## ALUMINIJ LOVILEC VODE S CEVJO IN GUMBOM

P-PZVHAG

Nominalna velikost	100	
Cena v €/kos	Brez DDV	Z DDV
<b>TM</b> 1 Testa di Moro RAL 8028	60,00	<b>73,20</b>
		018809
<b>AN</b> 2 Antracit RAL 7016	60,00	<b>73,20</b>
		018502
<b>IC</b> 3 Črna intenzivno RAL 9005	60,00	<b>73,20</b>
		018564
<b>OC</b> 4 Vinsko rdeča RAL 3009	60,00	<b>73,20</b>
		018717
<b>MH</b> 5 Opečno rdeča RAL 8004	60,00	<b>73,20</b>
		018595
<b>SB</b> 6 Umazano bela RAL 9002	60,00	<b>73,20</b>
		018779
<b>BH</b> 7 Srebrna RAL 9006	60,00	<b>73,20</b>
		018533
<b>PS</b> 8 Prašno siva RAL 7037	60,00	<b>73,20</b>
		018748
<b>MM</b> 9 Metalik bakrena RAL extra	60,00	<b>73,20</b>
		018625 *
<b>BHT – P.20</b> 10 Temno srebrna RAL 9007	60,00	<b>73,20</b>
		095534 *
<b>MZ</b> 11 Zelena mahovo RAL 6005	60,00	<b>73,20</b>
		018687
<b>MOT</b> 12 Temno modra RAL 5010	60,00	<b>73,20</b>
		018656 *
<b>TZ</b> 13 Zelena svetlo RAL 6011	60,00	<b>73,20</b>
		018830 *
<b>Pakiranje v kos</b> 		<b>1</b>
<b>Pakiranje v kos</b> 		<b>60</b>



\* Izdelava po meri

## ZAŠČITNA CEV Z REVIZIJSKO ODPRTINO

P-POZR

Nominalna velikost	80		100		100		
	1,0		1,0		1,5		
Dolžina v m	1,0		1,0		1,5		
Cena v €/m	Brez DDV	Z DDV	Brez DDV	Z DDV	Brez DDV	Z DDV	
<b>TM</b> Testa di Moro RAL 8028	1	64,00	<b>78,08</b>	49,00	<b>59,78</b>	97,00	<b>118,34</b>
		010254 *		010261		010278	
<b>AN</b> Antracit RAL 7016	2	64,00	<b>78,08</b>	49,00	<b>59,78</b>	97,00	<b>118,34</b>
		009760 *		009777		009784 *	
<b>IC</b> Črna intenzivno RAL 9005	3	64,00	<b>78,08</b>	49,00	<b>59,78</b>	97,00	<b>118,34</b>
		009869 *		009876		009883 *	
<b>OC</b> Vinsko rdeča RAL 3009	4	64,00	<b>78,08</b>	49,00	<b>59,78</b>	97,00	<b>118,34</b>
		010117 *		010124 *		010131 *	
<b>MH</b> Opečno rdeča RAL 8004	5	64,00	<b>78,08</b>	49,00	<b>59,78</b>	97,00	<b>118,34</b>
		009913 *		009920 *		009937 *	
<b>SB</b> Umazano bela RAL 9002	6	64,00	<b>78,08</b>	49,00	<b>59,78</b>	97,00	<b>118,34</b>
		010209 *		010247 *		010216 *	
<b>BH</b> Srebrna RAL 9006	7	64,00	<b>78,08</b>	49,00	<b>59,78</b>	97,00	<b>118,34</b>
		009814 *		009821 *		009838 *	
<b>PS</b> Prašno siva RAL 7037	8	64,00	<b>78,08</b>	49,00	<b>59,78</b>	97,00	<b>118,34</b>
		010162 *		010179 *		010186 *	
<b>MM</b> Metalik bakrena RAL extra	9	64,00	<b>78,08</b>	49,00	<b>59,78</b>	97,00	<b>118,34</b>
		009968 *		009975 *		009982 *	
<b>BHT – P.20</b> Temno srebrna RAL 9007	10	64,00	<b>78,08</b>	49,00	<b>59,78</b>		
		096494 *		096500 *			
<b>MZ</b> Zelena mahovo RAL 6005	11	64,00	<b>78,08</b>	49,00	<b>59,78</b>	97,00	<b>118,34</b>
		010063 *		010070 *		010087 *	
<b>MOT</b> Temno modra RAL 5010	12	64,00	<b>78,08</b>	49,00	<b>59,78</b>	97,00	<b>118,34</b>
		010018 *		010025 *		010032 *	
<b>TZ</b> Zelena svetlo RAL 6011	13	64,00	<b>78,08</b>	49,00	<b>59,78</b>	97,00	<b>118,34</b>
		010308 *		010315 *		010322 *	
<b>Pakiranje v kos</b>		1		1		1	
<b>Pakiranje v kos</b>		70		60		60	

\* Izdelava po meri



POCINKANO  
POLYESTER



# POCINKANO POLYESTER

## ZAŠČITNA CEV Z REVIZIJSKO ODPRTINO

P-POZR



Nominalna velikost	120		120	
	1,0		1,5	
Dolžina v m				
Cena v €/m	Brez DDV	Z DDV	Brez DDV	Z DDV
<b>TM</b> 1 Testa di Moro RAL 8028	115,00	<b>140,30</b>	165,00	<b>201,30</b>
	010285		010292 *	
<b>AN</b> 2 Antracit RAL 7016	115,00	<b>140,30</b>	165,00	<b>201,30</b>
	009791 *		009807 *	
<b>IC</b> 3 Črna intenzivno RAL 9005	115,00	<b>140,30</b>	165,00	<b>201,30</b>
	009890 *		009906 *	
<b>OC</b> 4 Vinsko rdeča RAL 3009	115,00	<b>140,30</b>	165,00	<b>201,30</b>
	010148 *		010155 *	
<b>MH</b> 5 Opečno rdeča RAL 8004	115,00	<b>140,30</b>	165,00	<b>201,30</b>
	009944 *		009951 *	
<b>SB</b> 6 Umazano bela RAL 9002	115,00	<b>140,30</b>	165,00	<b>201,30</b>
	010223 *		010230 *	
<b>BH</b> 7 Srebrna RAL 9006	115,00	<b>140,30</b>	165,00	<b>201,30</b>
	009845 *		009852 *	
<b>PS</b> 8 Prašno siva RAL 7037	115,00	<b>140,30</b>	165,00	<b>201,30</b>
	010193 *		009753 *	
<b>MM</b> 9 Metalik bakrena RAL extra	115,00	<b>140,30</b>	165,00	<b>201,30</b>
	009999 *		010001 *	
<b>BHT – P.20</b> 10 Temno srebrna RAL 9007	115,00	<b>140,30</b>		
	096517 *			
<b>MZ</b> 11 Zelena mahovo RAL 6005	115,00	<b>140,30</b>	165,00	<b>201,30</b>
	010094 *		010100 *	
<b>MOT</b> 12 Temno modra RAL 5010	115,00	<b>140,30</b>	165,00	<b>201,30</b>
	010049 *		010056 *	
<b>TZ</b> 13 Zelena svetlo RAL 6011	103,00	<b>125,66</b>	150,00	<b>183,00</b>
	010339 *		010346 *	
<b>Pakiranje v kos</b>	1		1	
<b>Pakiranje v kos</b>	40		40	

\* Izdelava po meri

## OBJEMKA Z GUMO M10

P-POB-OZR



Nominalna velikost	EAN številko izdelka	Pakiranje v kos		Cena [€/kos]	
				Brez DDV	Z DDV
80	002525	25	1 250	1,55	<b>1,89</b>
100	002532	25	1 250	2,00	<b>2,44</b>
120	002549	20	1 000	2,25	<b>2,75</b>

# POCINKANO POLYESTER

POCINKANO  
POLYESTER

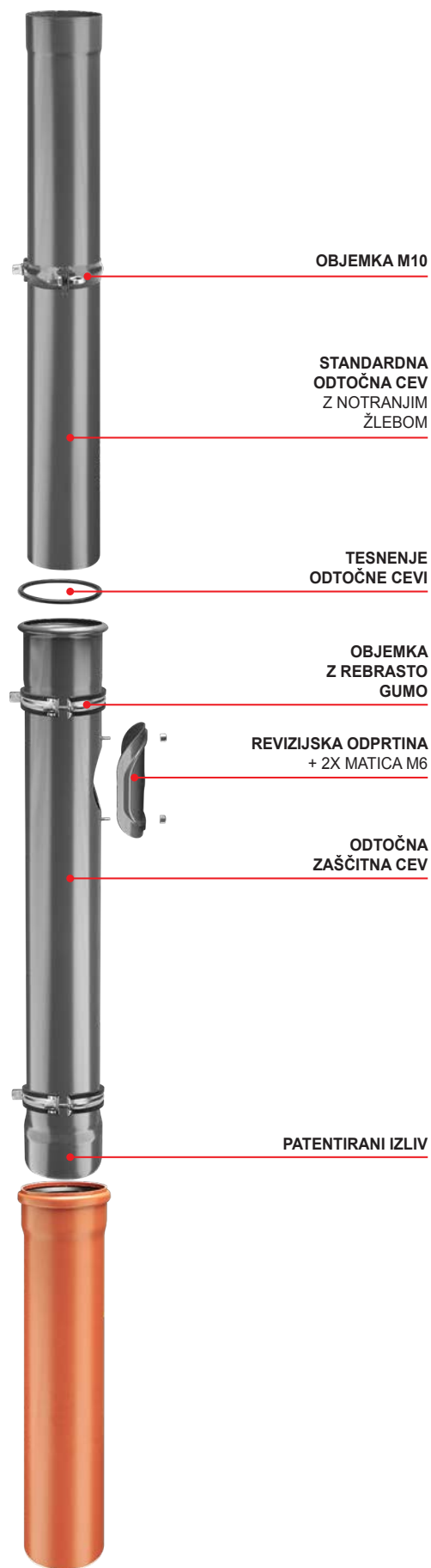
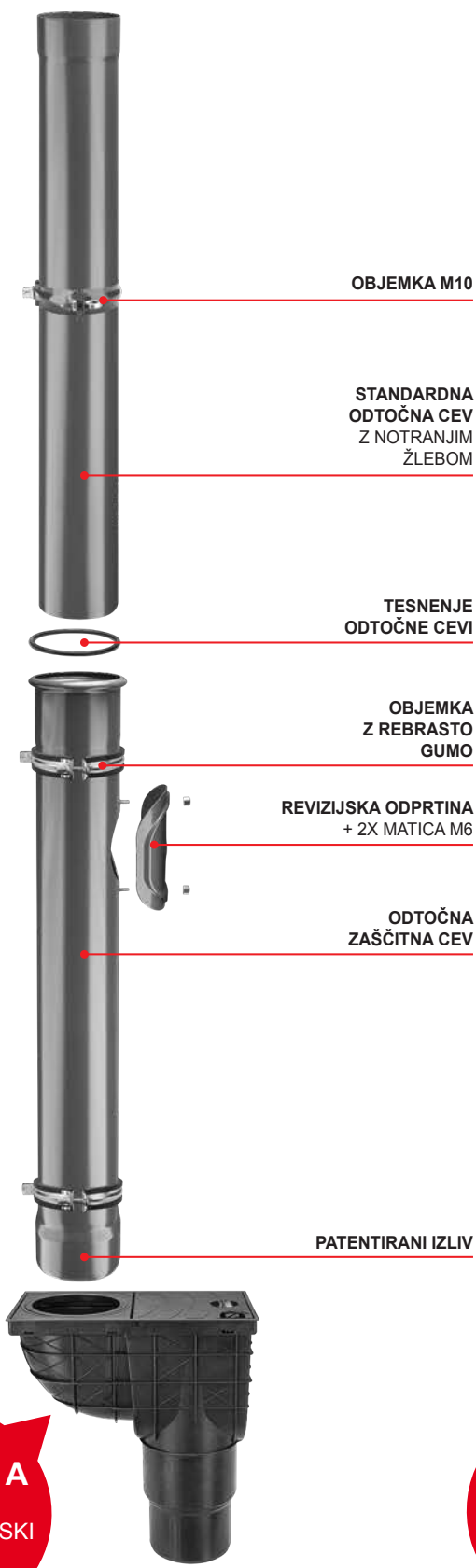

## I. OSNOVNA DOLOČILA

- Družba KJG a.s., s sedežem Malinovského 800/131, 916 21 Čachtice, MŠ: 31 439 951 (v nadaljevanju „prodajalec“), izdaja naslednje splošne poslovne pogoje za prodajo in dobavo žlebnega strešnega sistema in opreme, lahke strešne kritine, trapezov, metalurškega materiala, strešnih dodatkov, orodij, strojev in drugega blaga v povezavi s strešnim sistemom (v nadaljevanju „blago“), ki jo prodajalec izvaja na podlagi okvirne kupne pogodbe (v nadaljevanju „OKP“) v odnosu do podjetnika pri izvajanju njegove poslovne dejavnosti in do države, državne ustanove, upravne enote ali javne institucije za zagotavljanje javnih potreb ali lastnega obratovanja (v nadaljevanju „kupec“).
- Splošni poslovni pogoji so kot del OKP sestavni del vsake posamezne kupoprodajne pogodbe (v nadaljevanju tudi „pogodba“), ki jo sklene prodajalec in kupec na podlagi OKP.

## II. SKLENITEV KUPNE POGODBE

- Pisno naročilo kupca pomeni predlog za sklenitev posamezne kupoprodajne pogodbe, pri čemer mora vsako naročilo kupca vsebovati:
  - identifikacijske podatke kupca, ki so potrebni za izdajo računa;
  - opredelitev naročenega blaga (zlasti tip, vrsto, količino in mere);
  - kraj dobave, dobavni rok in način dobave blaga;
  - datum naročila;
  - ime, priimek, funkcija in podpis osebe, ki lahko zastopa kupca.
- Posamezna kupoprodajna pogodba je sklenjena v trenutku, ko prodajalec pisno potrdi naročilo kupca.

## III. KUPNINA IN PLAČILNI POGOJI

- Kupec se zavezuje, da bo prodajalcu redno in pravočasno plačal kupnino za naročeno blago. Kupnina je določena po ceniku prodajalca (cene blaga so brez DDV), ki je veljaven na dan naročila kupca. Kupnino bo prodajalec v potrdilu naročila navedel po veljavnih pravnih predpisih vključno z DDV (pri dobavi blaga v Slovenski republiki). V nujnih primerih, kadar se kupnina določi kot samostojna cenovna kalkulacija na podlagi veljavnega cenika, kupec plača kupnino po cenovni kalkulaciji, ki jo prodajalec določi kot končni znesek kupnine glede na stroške, a ne sme biti višja od kupnine, ki je bila določena s kalkulacijo. Kupec ima pravico do popusta na ceno blaga v skladu z OKP. Če prodajalec spremeni v času trajanja OKP višino popusta za kupca pri ceni blaga, nemudoma kupca o tem dejstvu obvesti. Pri dobavi blaga v Slovenski republiki zaračuna prodajalec kupcu tudi DDV po veljavnih pravnih predpisih.
- Kupec ima za naročila blaga določen finančni kreditni limit in zapadlost računov v smislu OKP, prodajalec pa lahko fakturira kupnino kupcu z dnem dobave oziroma odpreme blaga. Po porabi kredita v smislu OKP ali v primeru neplačanega računa s strani kupca v roku zapadlosti, prodajalec lahko prekine dobavo blaga kupcu na podlagi pogodbe in ne potrdi drugega pisnega naročila kupca. S prekinjenimi dobavami blaga prodajalec nadaljuje:
  - v primeru prekoračitve kreditnega limita: s plačilom najstarejših računov do zneska preseženega kreditnega limita in plačilu vrednosti zahtevane odpreme blaga;
  - v primeru neplačanega zapadlega računa: po plačilu računa v celotni višini. Prodajalec lahko kadarkoli v času veljavnosti OKP spremeni kreditni limit kupca.
- Plačilo šteje za pravočasno v primeru priliva na račun prodajalca ali gotovinskega plačila v blagajni prodajalca do roka zapadlosti.
- Če kupec ne plača računa v roku zapadlosti, prodajalec lahko obračuna zamudne obresti v višini 0,05 % neplačanega zneska za vsak dan zamude.

## IV. DOBAVA BLAGA IN PRIDRŽEK LASTNINE

- Prodajalec mora dobaviti blago kupcu v pogodbeno dogovorjeni količini, kakovosti in izvedbi, ki je primerna za namembno uporabo blaga. Dobavljeno blago prodajalca mora kupec prevzeti.
- Če se pogodbeni stranki nista dogovorili drugače, prodajalec mora blago zapakirati ali opremiti za prevoz na način, ki je običajen za zadevno blago v poslovnem stiku.
- Dobava blaga se izvede v roku in na način, ki sta ga pogodbeni stranki dogovorili s pogodbo.
- Pri dobavi blaga prodajalcu mora zaposleni pri kupcu izkazati pravico do prevzema blaga.
- Če se blago izroča na sedežu prodajalca (oziroma v pripadajočem skladišču prodajalca, ki mu kupec predloži naročilnico) brez nakladanja na prevozno sredstvo, mora prevoznik, ki ga določi kupec, izkazati pravico do prevzema blaga.
- Če se blago dobavi kupcu na kraj dobave, ki je naveden v naročilu, z vozilom prodajalca, zaračuna prodajalec kupcu stroške prevoza po ceniku prevoza, ki je veljaven na dan predložitve naročila s strani kupca. Prodajalec si pridržuje pravico do razkladanja blaga samo v dostopnem terenu po njegovi presoji.
- Če ni določeno drugače, zaračuna prodajalec poštno stroške za pošiljanje blaga kupcu.
- Kupec se zavezuje, da bo v dobavnem roku blago prevzel. Če kupec obveznosti glede prevzema blaga v dobavnem roku ne izpolni, prodajalec ga pozove za izpolnitev obveznosti v dodatnem primernem roku. Če kupec blaga ne prevzame niti v dodatnem primernem roku, prodajalec lahko od pogodbe odstopi.
- Kupec, ki do dneva dobave blaga ne plača celotne kupnine, pridobi pravico do dobavljenega blaga šele s plačilom celotnega zneska kupnine.

## V. PREHOD NEVARNOSTI ZA NASTANEK ŠKODE

- Nevarnost nastanka škode na blagu preide na kupca v trenutku prevzema blaga od prodajalca oziroma njegovega prevoznika; če kupec blaga ne prevzame pravočasno, preide nevarnost za nastanek škode na kupca v trenutku, ko prodajalec ali njegov prevoznik omogoči razpolaganje z blagom in kupec blaga ni prevzel ter je kršil pogodbo, čeprav je za možnost prevzema blaga vedel.
- Če prodajalec izroči blago za prevoz prevozniku, ki ga je določil kupec, na svojem sedežu v kraju Čachtice (oziroma v pripadajočem skladišču prodajalca), od katerega bo kupec blago prevzel, preide nevarnost za nastanek škode na kupca v trenutku izročitve blaga prevozniku.
- Če mora prodajalec odpustiti blago kupcu, preide nevarnost za nastanek škode na blagu na kupca v trenutku izročitve blaga prvemu prevozniku za prevoz do namembnega kraja.
- Kupec mora pregledati blago takoj po prehodu nevarnosti za nastanek škode na blagu. Če se blago pošilja kupcu, mora blago pregledati takoj po dobavi v namembni kraj.

## VI. ODGOVORNOST ZA NAPAKE IN GARANCIJA

- Prodajalec je odgovoren za napake blaga v trenutku prehoda nevarnosti za nastanek škode na kupca, četudi postane napaka očitna šele kasneje. Prodajalec je odgovoren tudi za vsako napako, ki nastane po prehodu nevarnosti nastanka škode na kupca, če škoda nastane zaradi kršitve njegovih obveznosti.
- Če kupec ne pregleda ali ne zagotovi pregleda blaga v času prehoda nevarnosti za nastanek škode na blagu, lahko uveljavi pravice za napake, ki bi jih lahko ugotovil ob takšnem pregledu, če izkaže obstoj takšne napake na blagu že v času prehoda nevarnosti za nastanek škode na blagu.
- Kupec mora prodajalcu sporočiti napake blaga takoj, ko
  - a/ bo ugotovil napako;
  - b/ bi moral ob strokovni skrbi napako ugotoviti ob pregledu, ki ga mora opraviti ob prehodu nevarnosti za nastanek škode ali
  - c/ bo napako ugotovil pozneje, najpozneje pa v dveh letih od časa dobave blaga oziroma dostave blaga na namembni kraj, ki je določen v pogodbi. Pri napakah, na katere se nanaša garancija za kakovost, velja namesto tega roka garancijski rok.
- Če prodajalec nudi kupcu garancijo za kakovost blaga, navede takšno izjavo v samostojnem garancijskem listu, v katerem navede tudi reklamacijski postopek.
- Garancijski rok prične teči z dnem dobave blaga. Če blago odpošilja prodajalec, garancijski rok teče od dneva dostave blaga na namembni kraj. Garancijski rok ne teče v času, kadar kupec ne more blaga uporabljati zaradi napak, za katere je odgovoren prodajalec.
- V primeru dobave blaga z napako kupcu je izključena uporaba določil 436. in 437. člena, drugega, tretjega in četrtega odstavka 439. člena in 441. člena Trgovinskega zakonika, prodajalec v takšnem primeru nudi kupcu popust ali odstrani napake, ki jih kupec navaja:
  - a/ z dobavo manjkajočega blaga;
  - b/ s popravilom blaga ali dobavo nadomestnega blaga v primeru odstranljivih napakah ali
  - c/ dobavo nadomestnega blaga v primeru napak, ki jih ni mogoče odstraniti.
- Popust mora ustrezati razliki med vrednostjo, ki bi jo imelo blago brez napak, in vrednostjo, ki jo ima dobavljeno blago z napako, pri čemer je za določitev vrednosti odločen čas, ko bi morala biti izvedena redna dobava. Kupec, ki mu prodajalec nudi popust pri kupnini, ne more zahtevati nadomestila izgubljenega dohodka zaradi pomanjkljivih karakteristik blaga, na katerega se popust nanaša.
- Pri dobavi nadomestnega blaga lahko prodajalec zahteva, da mu kupec na njegove stroške vrne blago, ki je predmet zamenjave, in sicer v stanju, v kakršnem je bilo dobavljeno. To ne velja, če nezmožnost vračila blaga v tako navedenem stanju ni nastala z ravnanjem ali opustitvijo dolžnega ravnanja kupca, ali je sprememba stanja nastala zaradi rednega pregleda za namen ugotovitve napak blaga. Če pred odkritjem napak kupec blago ali del blaga proda ali blago v celoti ali delno porabi ali spremeni ob njegovi običajni uporabi, mora neprodano ali neuporabljeno ali spremenjeno blago vrniti in zagotoviti prodajalcu nadomestilo do višine, v kateri je imel iz navedene uporabe blaga korist.
- Odgovornost prodajalca za napake, na katere se ne nanaša garancija za kakovost, ne nastane, če so te napake nastale po prehodu nevarnosti za nastanek škode na blagu z zunanjimi dogodki in jih ni povzročil prodajalec ali osebe, s pomočjo katerih je izpolnjeval svojo obveznost.

## VII. VIŠJA SILA

- Če po sklenitvi pogodbe nastanejo nepredvidene in nespremenljive okoliščine, ki pomenijo trajno ali začasno oviro za izpolnjevanje obveznosti pogodbenih strani iz sklenjene pogodbe (vis maior), neizpolnitev obveznosti (ob trajni oviri) pogodbenih strani oziroma pozna izpolnitev obveznosti (ob začasni oviri) ne pomeni kršitve te pogodbe, pogodbeni stranki pa ni odgovorna za morebitno škodo, ki bi lahko nastala v povezavi z neizpolnitvijo pogodbenih obveznosti. Če je ovira za izpolnjevanje obveznosti iz pogodbe samo začasna, pogodbeni stranki se zavezuje, da bosta pristopili k izpolnjevanju svojih obveznosti nemudoma po odpravi takšne ovire. Vsaka pogodbeni stranka mora nemudoma obvestiti drugo pogodbeno stran o nastanku zgoraj navedenih ovir.
- Kot vis maior štejejo zlasti naravne nesreče, samovoljno ravnanje tretjih oseb, stavke, delovne izločitve, blokade, vojne (napovedane in nenapovedane), spremenjena politična situacija, ki izključuje ali nesorazmerno otežuje izvajanje pravic in obveznosti iz pogodbe ali drugi podobni dogodki.

## VIII. VARSTVO OSEBNIH PODATKOV

- Kupec (za namene tega člena tudi druga oseba, ki je podpisana v OKP in naročilu v imenu kupca) daje prodajalcu izrecno soglasje v smislu zakona št. 428/2002 Ur. l. o varstvu osebnih podatkov po veljavnem besedilu (v nadaljevanju samo »zakon«) z obdelavo osebnih podatkov, ki so navedeni v OKP in naročilu kupca.
  - a/ izvajanja pravic in obveznosti iz OKP in posamezne pogodbe;
  - b/ vodenja evidence, ki jo mora prodajalec voditi v skladu z zakonom ali na podlagi zakona;
  - c/ trženja.
- Kupec izrecno soglaša, da prodajalec lahko za namene iz alineje 8.2. posreduje njegove osebne podatke tretji osebi, ki jo je pooblastil za izvajanje zadevne dejavnosti.
- Kupec soglaša, da prodajalec obdeluje njegove osebne podatke:
  - a/ za čas, ko mora prodajalec voditi evidenco iz alineje 8.2. točka b);
  - b/ za nujno potreben čas za zaščito zakonskih pravic in pravno zagotovljenih interesov prodajalca.
- Kupec jemlje na znanje, da lahko svoje soglasje z obdelavo osebnih podatkov prekliche in zahteva uničenje svojih osebnih podatkov v primeru, da prodajalec oziroma tretje osebe, ki jim je prodajalec posredoval osebne podatke, kršijo zakonske obveznosti.

## IX. KONČNA DOLOČILA

- Kupec ne more na tretjo osebo prenesti ali tretji osebi odstopiti pravic iz OKP ali posamezne pogodbe brez izrecnega soglasja prodajalca.
- Če ni s splošnimi poslovnimi pogoji določeno drugače, OKP se lahko spremeni samo s pisnimi aneksi, ki jih podpisajo predstavniki obeh pogodbenih strani.
- Drugečni dogovori iz posamezne pogodbe med prodajalcem in kupcem imajo prednost pred določili OKP in temi splošnimi poslovnimi pogoji. Pravna razmerja, ki niso urejena z OKP, posamezno pogodbo in splošnimi poslovnimi pogoji, se ravnajo po Trgovinskem zakoniku in drugih splošno zavezujočih pravnih predpisih Slovenske republike, pri čemer so izključena kolizijska pravila in uporaba Konvencije Združenih narodov o pogodbah o mednarodni prodaji blaga (CISG) z dne 11.04.1980 in njihovih morebitnih dodatkov v primeru, da ima kupec sedež (kraj poslovanja) v drugi državi ali se blago dobavlja v drugo državo.
- Vse spore, ki nastanejo na podlagi OKP, bodo pogodbeni stranki reševale po mirni poti. Reševanje sporov, ki jih ne bo mogoče rešiti sporazumno, je v pristojnosti (izključno) pristojnega sodišča Slovenske republike.
- Te splošne pogoje izdaja prodajalec po 273. členu Trgovinskega zakonika, in sicer z veljavnostjo od 01.01.2017