

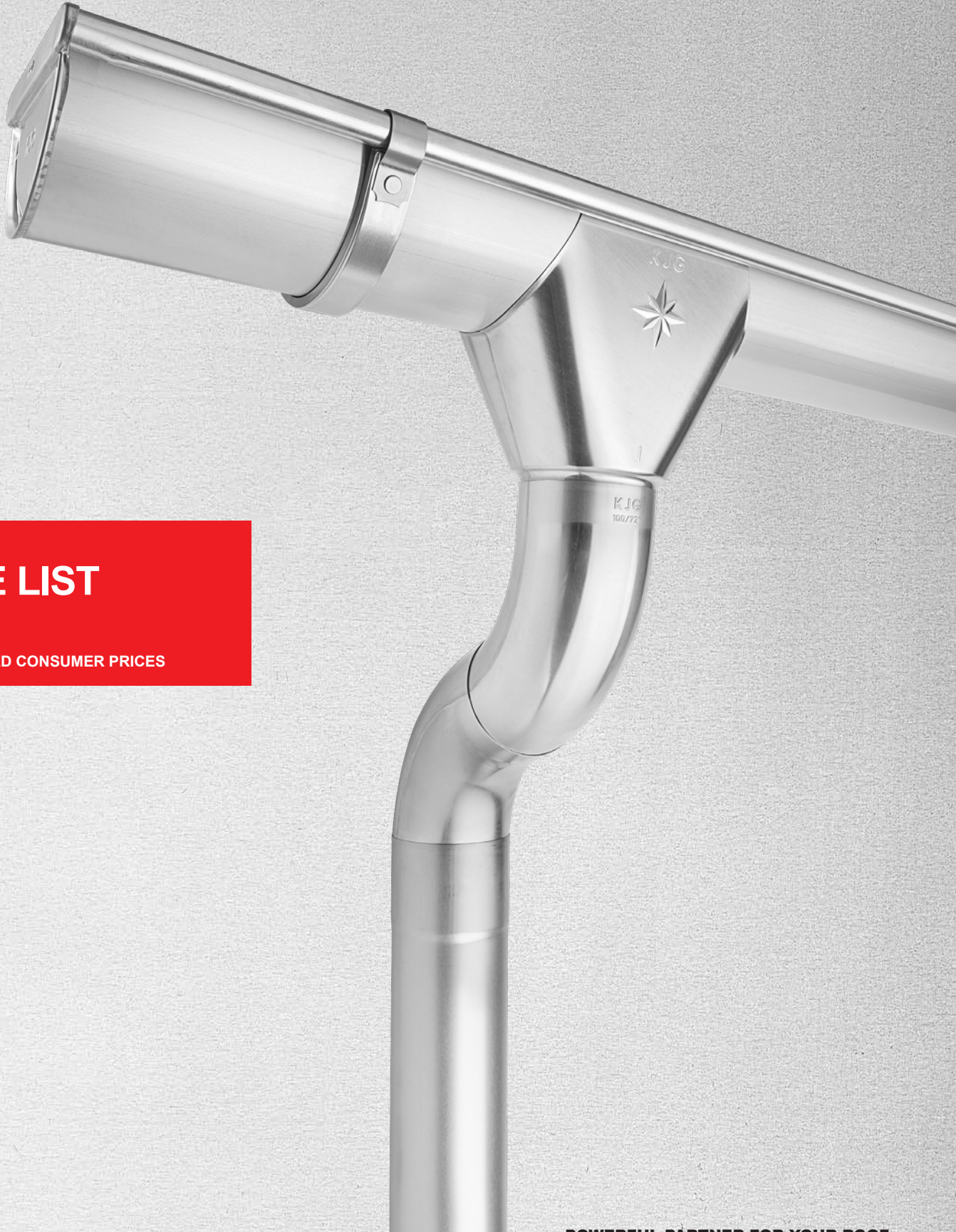

GUTTER SYSTEM SEMI CIRCULAR – CIRCULAR



PRICE LIST 2024

RECOMMENDED CONSUMER PRICES



POWERFUL PARTNER FOR YOUR ROOF

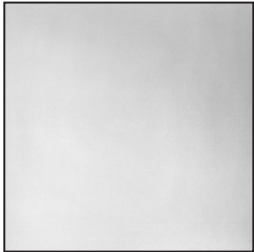

Titanium zinc material | 3

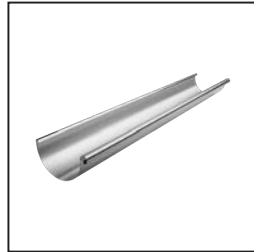

Gutter | 6

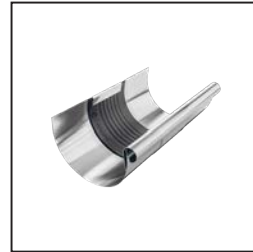

Gutter expanders | 8



Gutter accessories | 10



Gutter hook | 11

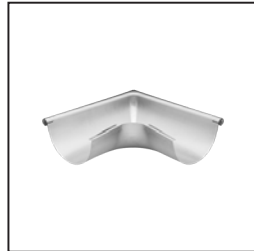

Corner | 12



End Cap | 12



Outlet | 13



Elbow | 17



Downpipe | 18

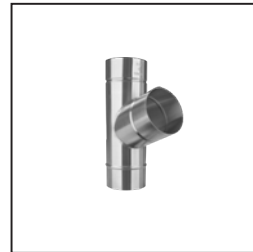

Downpipe accessories | 20



Pipe bracket | 21



Pipe bracket accessories | 22



Downpipe flap | 25



Protective gutter pipe | 26

GUTTER SYSTEM SEMI CIRCULAR – CIRCULAR

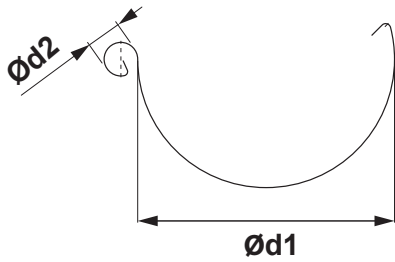

ROOF GUTTER DIMENSIONS

(dimensions and dimensional tolerances according to EN 612)

Developed width (mm)	200	250	280	333	400	500
$\varnothing d1$	80	105	127	153	192	250
$\varnothing d2$	16	18	18	20	22	22

WELDED TIG

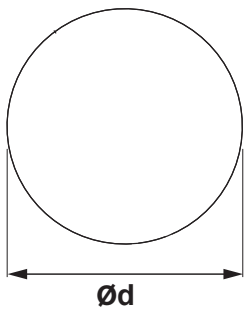

INNER FALZ

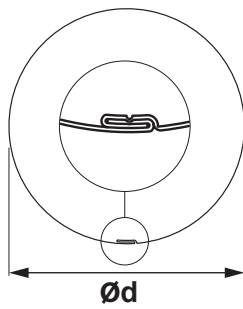

SPOUT PIPE DIMENSIONS

(dimensions and dimensional tolerances according to EN 612)

Dimensions	60	80	100	120	INNER FALZ 150
Nominal size $\varnothing d$ (mm)	60	80	100	120	150

GUTTER BRACKET DIMENSIONS

(dimensions and dimensional tolerances according to EN 612)

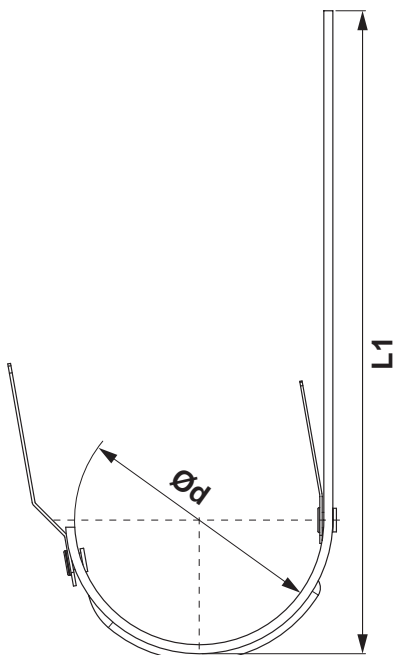

Dimensions (mm)	L1	$\varnothing d$
200	290	80
250	310	105
280	345	127
333 – 510	345	153
333 – 550	385	153
333 – 610	445	153
400	400	192

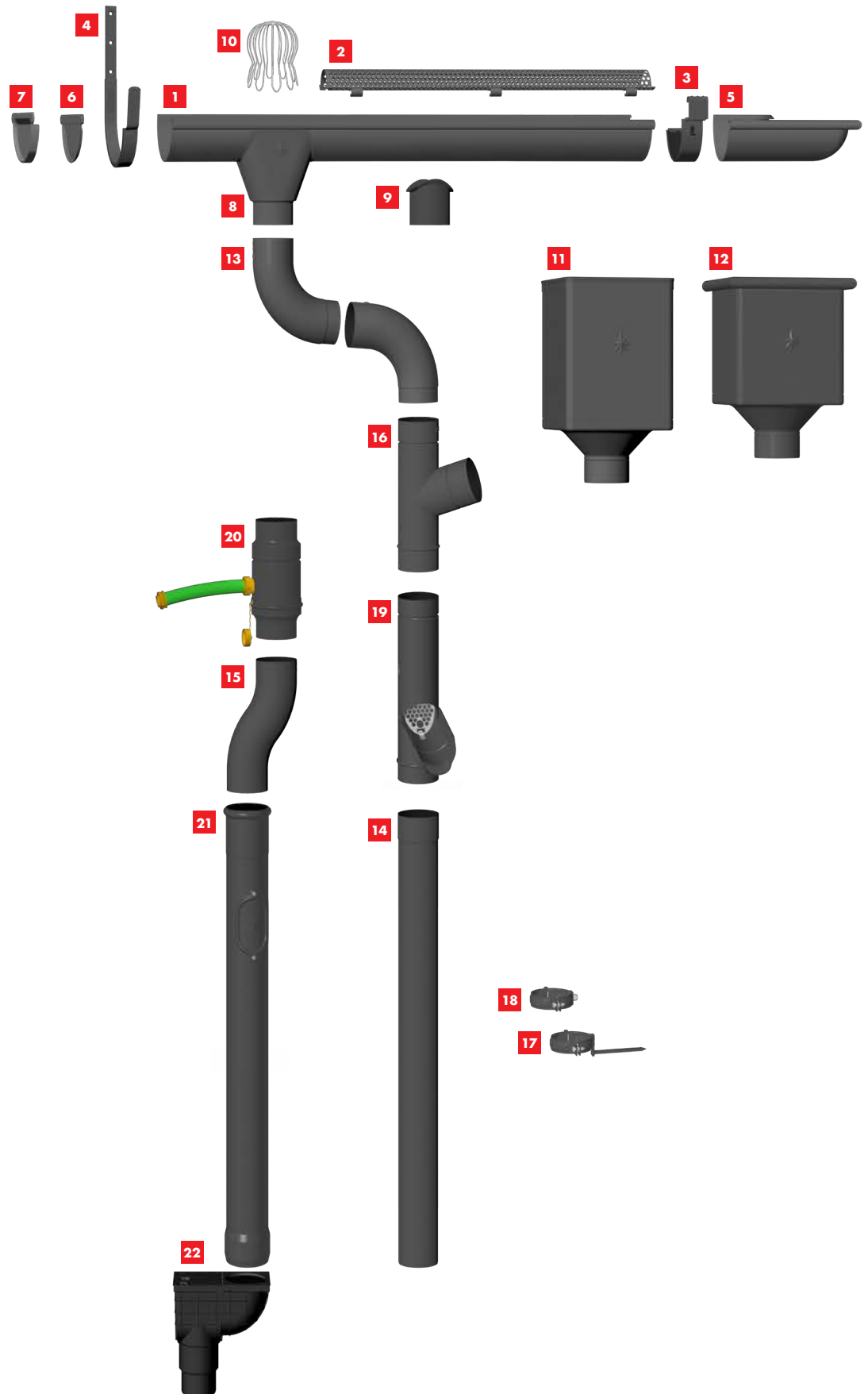

- 1** Gutter half-round
- 2** Gutter leaf guard
- 3** Gutter connector
- 4** Gutter hook
- 5** Corner outer
- 6** End Cap
- 7** End Cap with rubber seal
- 8** Outlet
- 9** Gutter outlet neck
- 10** Leaf sieve
- 11** Hopper DESIGN
- 12** Hopper CUBIC
- 13** Elbow
- 14** Downpipe
- 15** Double elbow
- 16** Downpipe branch
- 17** Pipe bracket with thread M10
- 18** Downpipe bracket with pin
- 19** Downpipe flap with sieve
- 20** Water collector+hose
- 21** Protec.gutter pipe col.
- 22** Rain drum,straight outlet



TITANIUM ZINC





GUTTER HALF-ROUND [s=0,65 mm]

TZ-TZZ





TITANIUM ZINC

Nominal dimension	Lenght in m	EAN product number	Packaging in m		Price with VAT [€/m]
					
200	3,0	047939	15	1 200	9,30
250	2,0	047946	10	480	8,88
250	3,0	047960	15	720	8,34
250	4,0	047984	20	960	8,34
250	5,0	047991	25	1 200	8,34
250	6,0	048004	30	1 440	8,34
280	2,0	048028	10	420	9,84
280	3,0	048042	15	630	9,30
280	4,0	048066	20	840	9,30
280	5,0	048080	25	1 050	9,30
280	6,0	048097	30	1 260	9,30
333	2,0	048103	10	330	10,92
333	3,0	048127	15	495	10,44
333	4,0	048141	20	660	10,44
333	5,0	048165	25	825	10,44
333	6,0	048196	30	990	10,44
400	4,0	048219	20	540	14,40
400	6,0	048233	30	810	14,40



GUTTER HALF-ROUND [s=0,70 mm]

TZ-TZZ



Nominal dimension	Lenght in m	EAN product number	Packaging in m		Price with VAT [€/m]
					
500 *	4,0	048257	20	–	27,48

* Custom production



GUTTER HALF-ROUND [s=0, 60 mm]

TZ-TZZ



Nominal dimension	Lenght in m	EAN product number	Packaging in m		Price with VAT [€/m]
					
250 *	3,0	047953	15	720	8,70
250 *	4,0	047977	20	960	8,70
333 *	3,0	048110	15	495	11,40
333 *	4,0	048134	20	660	11,40
333 *	5,0	048158	25	825	11,40
333 *	6,0	048189	30	990	11,40

* Custom production



GUTTER ON-ROOF

TZ-TZZS



Nominal dimension	Lenght in m	EAN product number	Packaging in m		Price with VAT [€/m]
					
650	4,0	000439	4	200	37,32

* Custom production

GUTTER EXPANDERS

TZ-TZZDI





Nominal dimension	EAN product number	Packaging in pcs		Price with VAT [€/pcs]
				
250/260	082688	3	360	16,20
280/260	082695	3	360	16,44
333/260	082701	5	200	16,44
400/260	082718	5	200	21,12



ON-ROOF GUTTER EXPANSION COMPONENT



TZ-TZZSDI

Nominal dimension	EAN product number	Packaging in pcs		Price with VAT [€/pcs]
				
670/260	082725	1	40	43,80



ENDLESS TAPES

TZ-TZZDIP

Nominal dimension	Lenght in m	EAN product number	Packaging in m		Price with VAT [€/m]
					
260	3,0	028020	3	120	54,00
260	6,0	028037	6	240	54,00

USE OF DILATATION GUTTER AND DILATATION STRIP

DILATATION GUTTER

Installation example: Hanging gutter with a developed width of up to 500 mm. The dilatation gutter shall be installed at spacing of 15 m. For outer corner and beginning of the gutter, a half of the standard value is applied: maximum 7,5 m. For inner corner, a quarter of the standard value is applied: maximum 3,75 m. For other materials and dimensions: see the table below. Corners are always taken into account as fixed points.

ROOF SEMICIRCULAR DILATATION GUTTERS

Developed gutter width	Aluminium	Steel, Titanium-zinc, Copper, Stainless steel
< 500	12	15
> 500	8	10

DILATATION STRIP

Indoor installation: on gutters attached without gluing to a substrate, roofs with non-standard profile and roof cladding

ROOF DILATATION STRIP

Developed gutter width	Aluminium	Steel, Titanium-zinc, Copper, Stainless steel
< 500	8	10
> 500	6	8

For outer corner or the beginning of the gutter, a half of the standard value shall be applied.

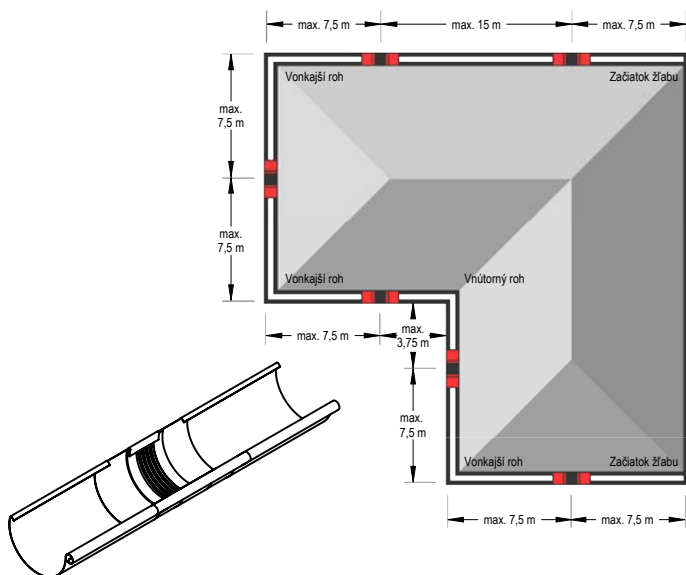

Note to the dilatation gutter mounting.

When mounting by soldering, first cover the middle rubber part with a wet cloth (to prevent heat transfer to the middle rubber part). A minimum distance of 6 cm from the middle rubber part must be kept. In any case avoid contact of rubber with open flame.

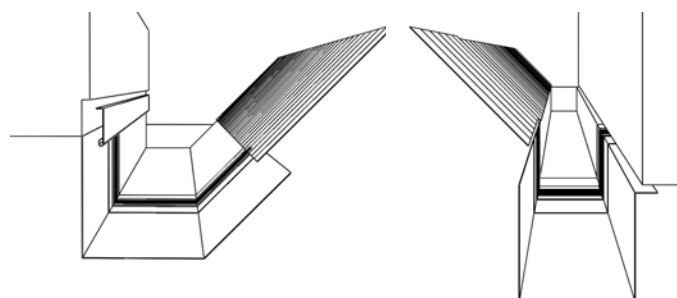

Note to the dilatation strip mounting.

When bending and mounting dilatation elements, make sure that:

- Bending jaws have a radius of at least 2 mm.
- For sheet metal thicknesses over 1 mm, it must be observed bending radius at least 5 mm.
- When bending, the bending jaws should be set to a thickness of the middle rubber part of 3 to 4 mm to prevent the cutting effect - damage to the rubber.
- The rubber middle part must not be compressed or damaged during bending. Therefore, an aluminium sheet strip 2 to 5 mm (thick) should be used, bent so that it can be attached as a protection to the bending jaws. This achieves a larger bending radius and prevents the rubber middle part from breaking.



ALUMINIUM GUTTER LEAF GUARD

W-WZNL M

Nominal dimension	Lenght in m	EAN product number	Packaging in pcs		Price with VAT [€/pcs]
333	2,0	064905	25	300	30,60

TITANIUM ZINC

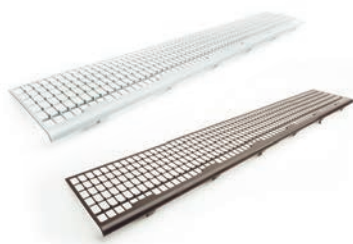

PVC GUTTER GUARD

SD-ZNL MRIEZKA

Nominal dimension	Lenght in m	EAN product number	Packaging in pcs		Price with VAT [€/pcs]
171	1,0	008473	30	450	5,40
171	1,0	008466	30	450	5,40

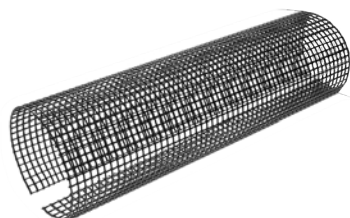

PVC GUTTER GUARD

SD-ZNL N



Nominal dimension	Lenght in m	EAN product number	Packaging in pcs		Price with VAT [€/pcs]
250	3,0	008480	10	400	28,68
280-333	3,0	008497	10	400	28,80



GUTTER CONNECTOR

TZ-TZSPZ





Nominal dimension	EAN product number	Packaging in pcs		Price with VAT [€/pcs]
				
250 *	102454	5	600	IN THE TESTING PROCESS
280 *	102461	5	600	IN THE TESTING PROCESS
333 *	102478	5	600	IN THE TESTING PROCESS

* Custom production

GUTTER HOOK

TZ-TZHOB





Nominal dimension	Material	EAN product number	Packaging in pcs		Price with VAT [€/pcs]
					
200/380	25/6	032805	10	1 000	5,28
250/430	25/6	032812	10	1 000	4,20
280/480	25/6	032829	10	1 000	4,56
333/550	25/6	032836	10	1 000	4,80
333/610	25/6	032843	10	1 000	5,70
400/650	25/6	032850	10	500	7,62

TITANIUM ZINC

ON-ROOF GUTTER HOOK WITH SUPPORT

TZ-TZHOBSSN





Nominal dimension	Material	EAN product number	Packaging in pcs		Price with VAT [€/pcs]
					
4	25/6	000910	15	300	20,76

CORNER OUTER

TZ-TZRA





Nominal dimension	EAN product number	Packaging in pcs		Price with VAT [€/pcs]
				
200	000811	5	150	18,00
250	000828	5	150	18,00
280	000835	5	150	19,92
333	000842	5	150	19,92
400	000859	5	150	39,48

CORNER INNER

TZ-TZRI





Nominal dimension	EAN product number	Packaging in pcs		Price with VAT [€/pcs]
				
200	000866	5	150	18,00
250	000873	5	150	18,00
280	000880	5	150	19,92
333	000897	5	150	19,92
400	000903	5	150	39,48

END CAP

TZ-TZCL





Nominal dimension	EAN product number	Packaging in pcs		Price with VAT [€/pcs]
				
200	001665	6/60	1 440	0,96
250	001672	50	4 500	0,84
280	001689	50	4 500	0,96
333	001696	50	4 500	1,14
400	001702	4/40	960	1,86

END CAP WITH RUBBER SEAL

TZ-TZCLG





Nominal dimension	EAN product number	Packaging in pcs		Price with VAT [€/pcs]
				
250 *	004390	25	2 250	IN THE TESTING PROCESS
280 *	004406	25	2 250	IN THE TESTING PROCESS
333 *	004413	25	2 250	IN THE TESTING PROCESS

* Custom production

OUTLET

TZ-TZKL



Nominal dimension	EAN product number	Packaging in pcs		Price with VAT [€/pcs]
				
200/60	003775	20	600	10,44
250/60	003782	20	600	9,72
250/80	003799	20	600	7,80
280/80	003805	20	600	9,78
280/100	003812	20	600	9,00
333/80	003829	20	600	12,00
333/100	003836	20	600	9,84
333/120	003843	15	300	13,80
400/100	003850	15	300	19,20
400/120	003867	15	300	21,24
400/150	003874	15	300	25,20

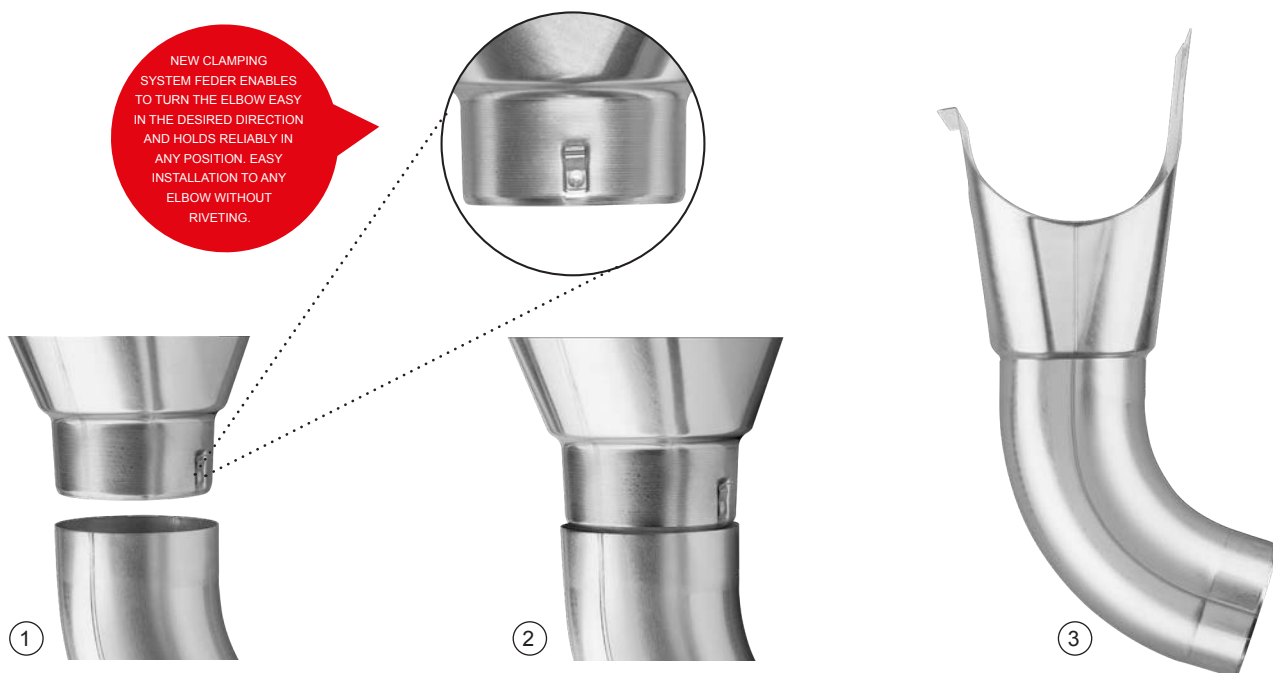

GUTTER OUTLET NECK

TZ-TZHRD



Nominal dimension	EAN product number	Packaging in pcs		Price with VAT [€/pcs]
80	102539	40	1 000	2,76
100	102546	25	1 000	3,12
120	102553	15	750	4,20

STAINLESS STEEL LEAF SIEVE

N-NZN



Nominal dimension	EAN product number	Packaging in pcs		Price with VAT [€/pcs]
60	001153	30	2 160	6,66
80	001160	20	1 440	6,72
100	001177	15	1 080	6,84
120	001184	10	720	7,44
150	001191	5	360	11,76



HOPPER DESIGN

TZ-TZKLZ DE



Nominal dimension	EAN product number	Packaging in pcs		Price with VAT [€/pcs]
80	007834	2	36	78,00
100	007858	2	36	78,00
120	007872	2	36	79,20

HOPPER DESIGN ECCENTRIC

TZ-TZKLZ DX



Nominal dimension	EAN product number	Packaging in pcs		Price with VAT [€/pcs]
80 *	007896	2	36	90,00
100	007926	2	36	90,00
120	007957	2	36	91,80

* Custom production

HOPPER CUBIC

TZ-TZKLZ KU



Nominal dimension	EAN product number	Packaging in pcs		Price with VAT [€/pcs]
80 *	007841	2	36	116,64
100	007865	2	36	116,64
120	007889	2	36	116,64

* Custom production

HOPPER CUBIC ECCENTRIC

TZ-TZKLZ KX



Nominal dimension	EAN product number	Packaging in pcs		Price with VAT [€/pcs]
80	007902	2	36	117,60
100	007933	2	36	117,60
120	007964	2	36	120,00

HOPPER CUBIC ECCENTRIC WITH OVERFLOW PIPE

TZ-TZKLZ KXV





Nominal dimension	EAN product number	Packaging in pcs		Price with VAT [€/pcs]
80	007919	2	36	164,40
100	007940	2	36	164,40
120	007971	2	36	165,60

RUBBER SEAL FOR HOPPER

P-PKLZ T



Nominal dimension	EAN product number	Packaging in pcs		Price with VAT [€/pcs]
				
IC 70-85	077103	5	600	4,80
IC 100-110	077110	5	600	4,92
IC 110-125	077097	5	600	5,04
PS 70-85	077134	5	600	5,40
PS 100-110	077141	5	600	5,88
PS 110-125	077127	5	600	6,00

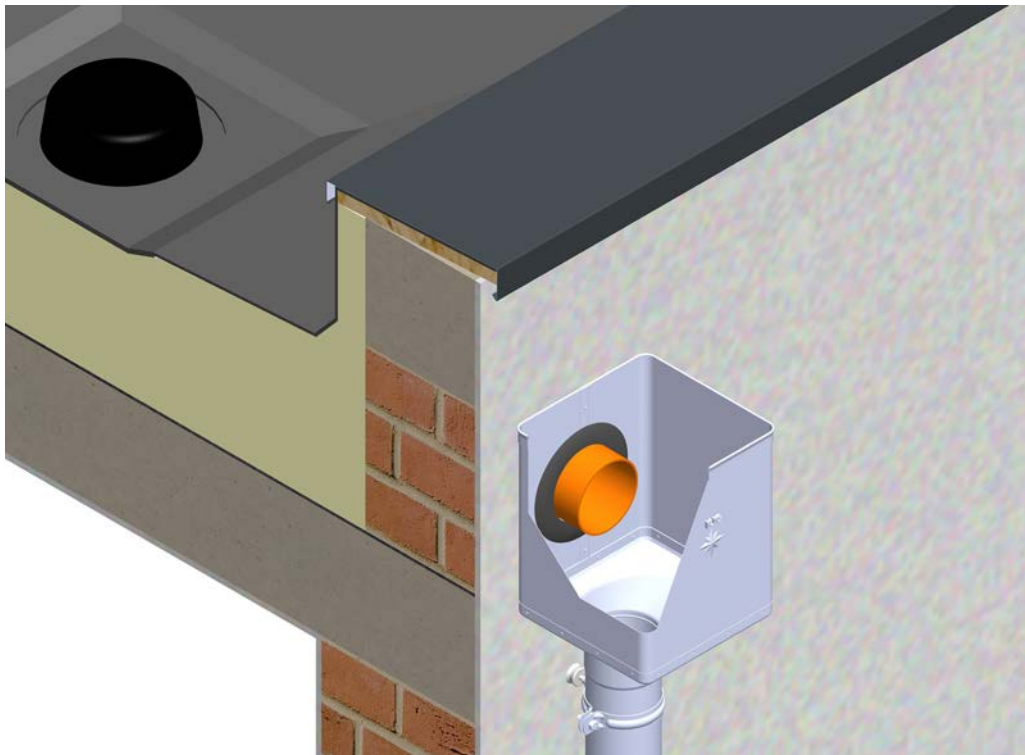

TITANIUM ZINC

ELBOW 72°

TZ-TZK



Nominal dimension	EAN product number	Packaging in pcs		Price with VAT [€/pcs]
60	083081	25	600	7,32
80	083098	25	400	5,34
100	083111	25	300	6,24
120	083135	15	180	13,44
150	083159	5	90	46,80

ELBOW RADIUS 85°

TZ-TZKR



Nominal dimension	EAN product number	Packaging in pcs		Price with VAT [€/pcs]
80	083104	25	400	9,36
100	083128	25	300	9,96
120	083142	15	180	21,96

TITANIUM ZINC

ELBOW BLIND 40°

TZ-TZKT



Nominal dimension	EAN product number	Packaging in pcs		Price with VAT [€/pcs]
80	083166	25	400	6,48
100	083173	25	300	8,28
120	083180	15	240	16,20

DOWNPIPE [s=0,65 mm]

TZ-TZZR





Nominal dimension	Lenght in m	EAN product number	Packaging in m		Price with VAT [€/m]
60	2,0	047618	2	490	8,28
60	3,0	047625	3	735	8,28
80	1,0	047649	10	100	9,12
80	2,0	047663	2	250	8,76
80	3,0	047687	3	375	8,76
80	4,0	047694	4	500	8,76
80 *	5,0	047700	5	625	8,76
80 *	6,0	047717	6	750	8,76
100	1,0	047731	10	70	11,04
100	2,0	047755	2	160	10,68
100	3,0	047779	3	240	10,68
100	4,0	047793	4	320	10,68
100 *	5,0	047816	5	400	10,68
100 *	6,0	047823	6	480	10,68
120	1,0	047830	8	48	14,10
120	2,0	047847	2	120	13,56
120	3,0	047854	3	180	13,56
120	4,0	047878	4	240	13,56
120 *	5,0	047892	5	300	13,56
120 *	6,0	047908	6	360	13,56

* Custom production



DOWNPIPE [s=0,70 mm]

TZ-TZZR



Nominal dimension	Lenght in m	EAN product number	Packaging in m		Price with VAT [€/m]
					
150 ¹	4,0	047922	4	112	29,76

¹ Inner FALZ



DOWNPIPE [s=0, 60 mm]

TZ-TZZR



Nominal dimension	Lenght in m	EAN product number	Packaging in m		Price with VAT [€/m]
					
80 *	1,0	047632	10	100	9,36
80 *	2,0	047656	2	250	9,36
80 *	3,0	047670	3	375	9,24
80 *	4,0	081742	4	500	9,24
80 *	5,0	081759	5	625	9,24
80 *	6,0	081766	6	750	9,24
100 *	1,0	047724	10	70	11,52
100 *	2,0	047748	2	160	11,52
100 *	3,0	047762	3	240	11,40
100 *	4,0	047786	4	320	11,40
100 *	5,0	047809	5	400	11,40
100 *	6,0	081773	6	480	11,40

* Custom production



PLASTIC DOWNPIPE SLEEVE

SD-ZR FOLIA KJG

Rozmiar nominalny	Lenght in m	EAN product number	Packaging in m		Price with VAT [€/m]
					
60-150	100,0	139726	100	6 000	0,46



DOUBLE ELBOW

TZ-TZKO

Nominal dimension	EAN product number	Packaging in pcs		Price with VAT [€/pcs]
80	047380	20	320	11,04
100	047397	20	240	13,44
120	047403	15	180	25,20

TITANIUM ZINC



DOWNPIPE BRANCH 72°

TZ-TZZO

Nominal dimension	EAN product number	Packaging in pcs		Price with VAT [€/pcs]
80/80	102560	4	90	20,16
100/60	102577	4	120	21,60
100/80	102584	4	120	21,60
100/100	102591	4	120	21,60
120/80	102607	3	90	26,88
120/100	102614	3	90	26,88
120/120	102621	3	90	26,88
150/120 *	102638	2	36	43,68
150/150 *	102645	2	36	47,40

* Custom production

DOWNPIPE BRACKET WITH PIN 150 mm

TZ-TZO



Nominal dimension	EAN product number	Packaging in pcs		Price with VAT [€/pcs]
80	008503	25	1 000	3,60
100	008510	25	1 000	3,96
120	008527	25	1 000	4,20

DOWNPIPE BRACKET WITH PIN 200 mm

TZ-TZOD



Nominal dimension	EAN product number	Packaging in pcs		Price with VAT [€/pcs]
80	008534	25	1 000	3,84
100	008541	25	1 000	4,14
120	008558	25	1 000	4,38

DOWNPIPE BRACKET WITH PIN 300 mm

TZ-TZODD



Nominal dimension	EAN product number	Packaging in pcs		Price with VAT [€/pcs]
100	008572	20	800	4,44
120	008589	20	800	4,92

PIPE BRACKET WITH THREAD M10



TZ-TZOB



Nominal dimension	EAN product number	Packaging in pcs		Price with VAT [€/pcs]
60	000132	25	3 000	4,74
80	000149	25	3 000	3,60
100	000156	25	3 000	3,84
120	000163	25	3 000	4,44
150	000170	20	2 400	6,00

STAINLESS STEEL SCREW FOR DOWNPIPE BRACKET M6x20 P-POB-NSK





Nominal dimension	EAN product number	Packaging in pcs		Price with VAT [€/pcs]
				
M6 x 20 *	071675	1	–	0,18

* Custom production

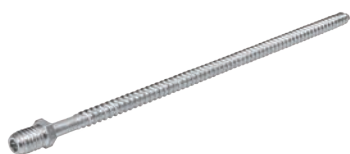
SCREW FOR DOWNPIPE BRACKET WITH THREADED TORX M10 P-POB-HT





TITANIUM ZINC

Nominal dimension	EAN product number	Packaging in pcs		Price with VAT [€/pcs]
				
80	002464	100	40 000	1,20
140	002471	100	28 000	1,50
200	002488	100	20 000	1,86
250	002495	100	16 000	2,04
300	002501	100	11 200	2,04



DOWEL M10 P-POB-HN DB



Nominal dimension	EAN product number	Packaging in pcs		Price with VAT [€/pcs]
				
120	002426	100	25 000	0,48



DOWEL WITH LAMELLA M10 P-POB-HN DB



Nominal dimension	EAN product number	Packaging in pcs		Price with VAT [€/pcs]
				
180	002433	100	12 000	0,50
240	002440	100	12 000	0,60
280	002457	100	12 000	0,64

COMBISCREW TORX M10 P-POB-ZT/SZ



Nominal dimension	EAN product number	Packaging in pcs		Price with VAT [€/pcs]
				
140	002587	50	10 400	0,54
180	002594	50	10 400	0,66

INSULATION DOWEL M10

P-POB-HN IZOL



Nominal dimension	EAN product number	Packaging in pcs		Price with VAT [€/pcs]
M10 x 96	001207	25	2 625	3,54

INSULATING DOWEL TIP OF THE BRICK WITHOUT INSULATION P-POB-HN WDVS140 M10



Nominal dimension	EAN product number	Packaging in pcs		Price with VAT [€/pcs]
140	144843	1/5	750	5,76

INSULATING DOWEL TIP OF THE BRICK WITH INSULATION P-POB-HN WDVS300 M10



Nominal dimension	EAN product number	Packaging in pcs		Price with VAT [€/pcs]
300	144850	1/5	500	9,36

STAINLESS STEEL UNI PLATFORM TO ATTACH OB M10 P-POB-HN PLAT M10



Nominal dimension	EAN product number	Packaging in pcs		Price with VAT [€/pcs]
M10	144836	25/500	5 000	4,02

THREADED ROD M10

P-POB-ZT



Nominal dimension	EAN product number	Packaging in pcs		Price with VAT [€/pcs]
60	002556	100	20 800	0,24
100	002563	100	15 600	0,36
150	002570	50	10 400	0,66

DOWNPIPE BRACKET MOUNTING PLATE M10

P-POB-ZT MP



Nominal dimension	EAN product number	Packaging in pcs		Price with VAT [€/pcs]
80 x 30	002518	25	5 200	1,38

RUBBER CAP FOR DOWNPIPE BRACKET SCREW

P-POB-HT AKG



Nominal dimension	EAN product number	Packaging in pcs		Price with VAT [€/pcs]
29 x 13	002280	50	16 800	0,30
29 x 13	002211	50	16 800	0,30
29 x 13	002235	50	16 800	0,30
29 x 13	002266	50	16 800	0,30
29 x 13	002242	50	16 800	0,30
29 x 13	002228	50	16 800	0,30
29 x 13	002273	50	16 800	0,30
29 x 13	002259	50	16 800	0,30
29 x 13	002297	50	16 800	0,30



DOWNPIPE FLAP

TZ-TZZV



Nominal dimension	EAN product number	Packaging in pcs		Price with VAT [€/pcs]
80	035011	6	180	12,72
100	035028	5	150	15,60
120	035035	3	90	19,92

DOWNPIPE FLAP WITH SIEVE

TZ-TZZVS



Nominal dimension	EAN product number	Packaging in pcs		Price with VAT [€/pcs]
80	034984	6	180	15,60
100	034991	5	150	17,88
120	035004	3	90	30,00

WATER COLLECTOR+HOSE

TZ-TZZVHA



Nominal dimension	EAN product number	Packaging in pcs		Price with VAT [€/pcs]
80	001450	1	60	87,60
100	001467	1	60	87,60
120	001474	1	60	162,00

TITANIUM ZINC



PROTEC.GUTTER PIPE COL.

P-POZR

Nominal dimension	Lenght in m	EAN product number	Packaging in pcs		Price with VAT [€/pcs]
80	1,0	009708	1	70	72,00
100	1,0	009715	1	60	54,00
100	1,5	009722	1	60	106,80



PROTEC.GUTTER PIPE COL.

P-POZR

Nominal dimension	Lenght in m	EAN product number	Packaging in pcs		Price with VAT [€/pcs]
120	1,0	009739	1	40	126,00
120	1,5	009746	1	40	171,60

TITANIUM ZINC



PIPE CLAMP WITH GASKET M10

P-POB-OZR

Nominal dimension	EAN product number	Packaging in pcs		Price with VAT [€/pcs]
80	002525	25	1 250	1,86
100	002532	25	1 250	2,40
120	002549	20	1 000	2,70

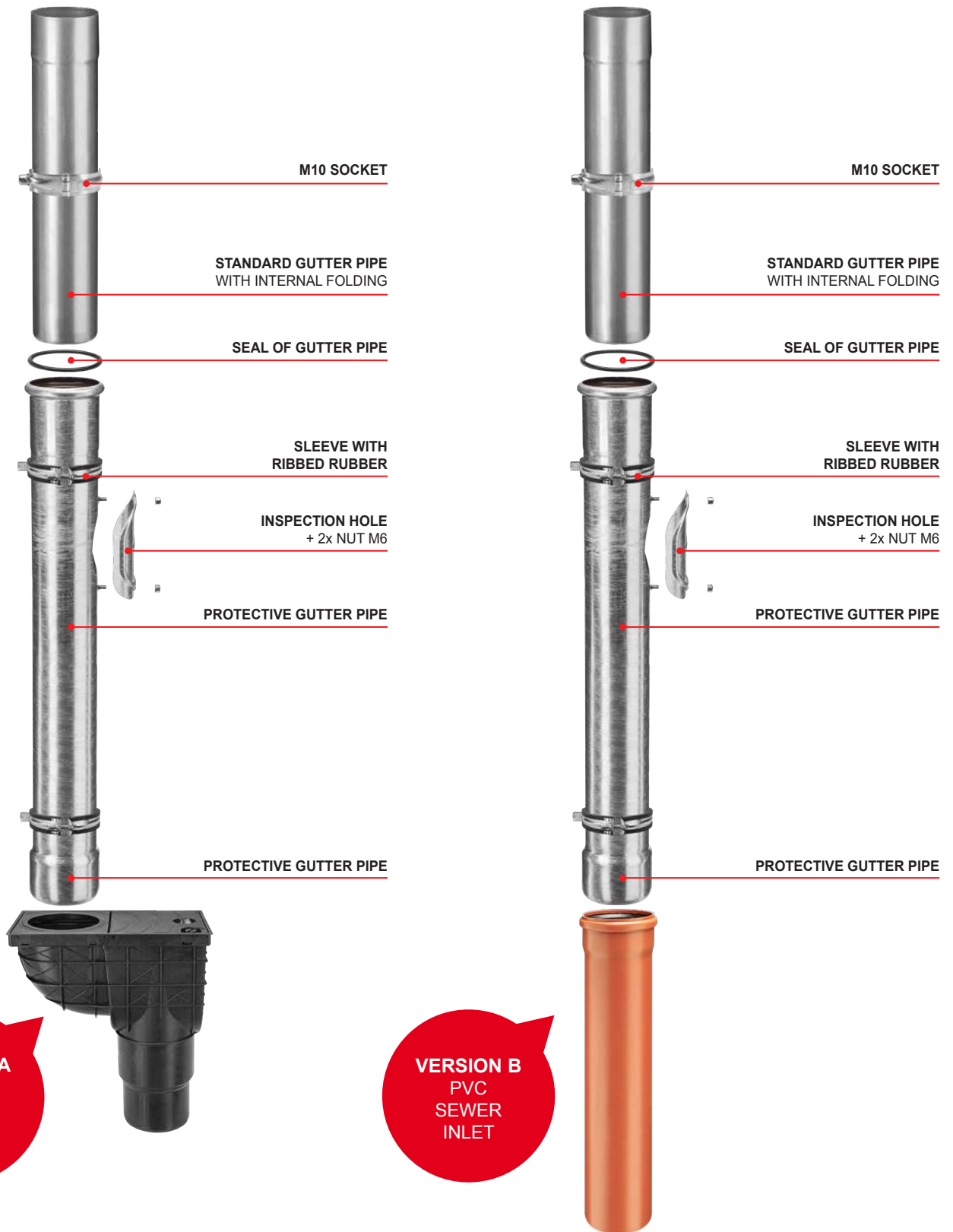

TITANIUM ZINC

VERSION A
PVC
SEWER
INLET

VERSION B
PVC
SEWER
INLET

I. BASIC PROVISIONS

- The company KJG a.s., with its registered office at Malinovského 800/131, 916 21 Čachtice, Company ID: 31 439 951 (hereinafter referred to as the „Seller“), issues the following General business terms and conditions that apply to the sale and supply of gutter roof system with accessories, light roofing, trapezoids, metallurgical materials, roofing accessories, tools, machinery and commercial goods related to the roof system (hereinafter referred to as the „goods“) performed by the Seller on the basis of a framework purchase contract (referred to as „FPC“) in relation to an entrepreneur in carrying out its business activities and to the state, state organization, self-governing territorial unit or to a legal entity established by law as a public institution in the provision of public needs or its own operation (hereinafter referred to as the „Buyer“).
- These General terms and conditions as an integrated part of FPC are an integral part of each individual purchase contract (hereinafter also „IPC“ or „contract“) concluded between the Seller and the Buyer on the basis of FPC.

II. CONCLUSION OF PURCHASE CONTRACT

- The Buyer's written order is considered to be a proposal to conclude an IPC, whereby each Buyer's order should contain:
 - identification data of the Buyer necessary for issuing the invoice,
 - specification of the ordered goods (especially type, kind, quantity and dimensions),
 - delivery place, delivery time and method of delivery of goods,
 - date of issue of the order,
 - name, surname, position and signature of the person authorized to act on behalf of the Buyer.
- The IPC is considered closed at the moment of written confirmation of the Buyer's order by the Seller.

III. PURCHASE PRICE AND PAYMENT TERMS

- The Buyer undertakes to pay the Seller the purchase price for the ordered goods properly and in due time. The purchase price is determined according to the Seller's price list (prices of goods are to be understood without VAT) valid on the day of submitting the order by the Buyer and its amount will be stated by the Seller in the Buyer's order confirmation including VAT (when delivering goods in Slovakia) according to valid legal regulations. In necessary cases, if the purchase price is determined on the basis of individual price calculation based on the valid price list, the Buyer shall be obliged to pay the purchase price up to the amount determined by price calculation on condition that the Seller shall determine the final purchase price according to costs incurred, but this shall not exceed the purchase price determined by calculation. The buyer is entitled to a discount on the price of the goods in the amount resulting from the FPC; if the Seller changes the amount of the Buyer's discount on the price of the goods during the FPC period, it shall immediately inform the Buyer in writing. When delivering the goods in the Slovak Republic, the Seller charges the Buyer, in addition to the price of the goods, VAT in accordance with the valid legal regulations.
- The Buyer shall have a set financial credit limit for the purchase of goods and the maturity of invoices in accordance with the FPC, while the Seller shall be entitled to invoice the purchase price to the Buyer on the day of delivery or shipping the goods to the Buyer, respectively. After overdrawing the credit limit specified in the FPC or in the case of non-payment of the invoice by the Buyer within the due date, the Seller is entitled to interrupt the delivery of goods to the Buyer on the basis of the contract and not to confirm another written order of the Buyer. The Seller shall continue with further deliveries of goods:
 - in the case of exceeded credit limit - after payment of the oldest invoices up to the amount of exceeding the credit limit and simultaneous payment of the value of the required purchase of goods,
 - in the case of non-payment of the invoice within the due date - after its full payment. The Seller shall be entitled to change the credit limit set for the Buyer at any time throughout the duration of the FPC.
- Payment shall be deemed to have been made in time if it has been credited to the Seller's account or paid in cash at the Seller's cash desk by the due date.
- If the Buyer does not pay the invoice within the due date, the Seller shall be entitled to charge the Buyer for interest on late payment in the amount of 0.05 % of the unpaid amount for each day of delay.

IV. DELIVERY OF GOODS AND RETENTION OF TITLE

- The Seller shall be obliged to deliver the goods to the Buyer in the quantity agreed in the contract and in a quality and design that is suitable for the purpose for which the goods are used. The Buyer is obliged to take over the goods delivered by the Seller.
- Unless the contracting parties have agreed otherwise, the Seller is obliged to pack or arrange the goods for transport in the manner that is usual for such goods in business.
- Delivery of the goods shall take place within the period and in the manner agreed by the contracting parties in the contract.
- Upon delivery of the goods by the Seller, the Buyer's employee shall be obliged to prove the right to take over the goods.
- If the goods are to be made available not loaded on a means of transport at the Seller's registered office (or the relevant warehouse of the Seller, to which the Buyer has submitted an order) by the Buyer to the designated carrier, the latter is obliged to prove the right to take over the goods.
- In the event that the goods are to be delivered to the Buyer to the delivery point specified in the order using a Seller's vehicle, the Seller will charge the Buyer for transport costs according to the transport price list valid on the day of submitting the order by the Buyer. At the same time, the Seller reserves the right to unload the goods only in an available terrain at its sole discretion.
- In the case of goods to be sent to the Buyer, the Seller shall charge the Buyer for postage, unless agreed otherwise.
- The Buyer undertakes to withdraw the goods within the delivery period. If the Buyer fails to fulfil its obligation to take over the goods within the delivery period, the Seller shall invite the Buyer to fulfil the Seller's obligation within an additional reasonable period. Failure to take over the goods by the Buyer nor within an additional reasonable period gives rise to the Seller's right to withdraw from the contract.
- The buyer who does not pay the whole amount of the purchase price until the delivery of the goods will acquire ownership of the delivered goods only after full payment of the purchase price.

V. PASSING OF RISK OF DAMAGE TO GOODS

- The risk of damage to the goods passes to the Buyer at the moment the Buyer takes over the goods from the Seller, or by the carrier designated by him, or if the Buyer fails to do so in time, at the time when the Seller or the Seller's designated carrier allows the Buyer to dispose of the goods, while the Buyer is being aware of this possibility and breaches the contract by not taking over the goods.
- If the Seller is to hand over the goods for transport by the carrier designated by the Buyer at its registered office in Čachtice (or the relevant warehouse of the Seller) from which the Buyer is to take over the goods, the risk of damage to the goods passes to the Buyer upon handing over the goods to this carrier.
- In the event that the Seller is to send the goods to the Buyer, the risk of damage to the goods passes to the Buyer at the time of delivery of the goods to the first carrier for transport to the destination.
- The buyer is obliged to inspect the goods without undue delay after the risk of damage to the goods has passed. If the goods are sent to the Buyer, the Buyer is obliged to inspect the goods without undue delay after their delivery to the destination. The company KJG a.s. reserves the right to change prices, packaging and printing.

VI. LIABILITY FOR DEFECTS AND WARRANTY

- The Seller shall be responsible for the defect by which the goods have been affected at the moment when the risk of damage to the goods passes to the Buyer, even if the defect becomes apparent only after this time. The Seller is also responsible for any defect arising after the risk of damage to the goods has passed to the Buyer if caused by a breach of the Buyer's duties.
- If the Buyer does not inspect the goods or does not arrange to inspect them at the time of passing the risk of damage to the goods, the Buyer may claim for defects detectable during this inspection only if the Buyer proves that the goods were already affected by these defects at the time of passing the risk of damage to the goods.
- The Buyer shall be obliged to notify the Seller of defects in the goods without undue delay after:
 - The Buyer found the defects,
 - The Buyer, while exercising professional care, should have found defects during the inspection, which the Buyer is obliged to carry out after the risk of damage to the goods has passed, or
 - The defects could be found later with the exercise of professional care, but no later than within two years from the time of delivery of the goods, or from the arrival of the goods to the destination specified in the contract. For defects covered by the quality warranty, instead of this period of time the warranty period applies.
- If the Seller provides the Buyer with a warranty for the quality of the delivered goods, it shall do so by making a statement in a separate warranty card, which will also state the procedure for complaints.
- The warranty period begins to run from the date of delivery of the goods. If the Seller is obliged to send the goods, the warranty period runs from the day the goods arrive at its destination. The warranty period does not run for a period during which the Buyer cannot use the goods due to their defects, which is the Seller's responsibility.
- In the case of delivery of goods to the Buyer with defects, the use of prov. § 436, § 437, § 439 par. 2, 3, 4 and § 441 of the Commercial Code are explicitly excluded and the Seller in such a case shall provide the Buyer with a discount on the purchase price or shall remove the defects in the goods complained by the Buyer:
 - by delivery of missing goods,
 - by repair of goods or delivery of replacement goods in case of remediable defects
 - by delivery of replacement goods in the event of irreparable defects.
- The discount granted by the Seller on the purchase price shall correspond to the difference between the value of the goods without defects and the value of the goods delivered with defects, while the decisive time for determining the values is the time at which proper fulfillment should have taken place. The Buyer, to whom the Seller has been granted a discount on the purchase price, is not entitled to claim compensation for the loss of profit due to the lack of properties of the goods to which the discount applies.
- Upon delivery of replacement goods, the Seller shall be entitled to demand the exchanged goods to be returned to the Seller at the Buyer's expense in the condition in which they were delivered to the Buyer. This does not apply if the impossibility of returning the goods in the condition specified therein is not caused by the actions or omissions of the Buyer, or if the change in the condition of the goods occurred as a result of an inspection duly performed to detect defects in the goods. In the event that before the detection of defects the Buyer sold the goods or part thereof or consumed the goods in whole or in part or altered them in their normal use, the Buyer shall be obliged to return unsold or unconsumed goods or altered goods and provide the Seller with compensation to the extent to which the Seller has benefited from that use of the goods.
- The Seller's responsibility for defects not covered by the quality warranty does not arise if these defects were caused after the passing of the risk of damage to the goods by external events and were not caused by the Seller or the persons who helped to fulfil the Seller's obligation.

VII. VIS MAJOR

- If, after the conclusion of the contract, unforeseeable and uncontrollable circumstances arise which create a permanent or temporary obstacle to the fulfillment of the obligations of the contracting parties of the concluded contract (refer to vis major), the non-fulfillment of obligations (in case of permanent obstacle) by a contracting party, or a delayed fulfillment of obligations (in case of temporary obstacle), shall not be considered a breach of this contract and the contracting party shall not be responsible for any damages that arise in connection with non-fulfillment of contractual obligations. If the obstacle incurred is only temporary for the fulfillment of obligations under the contract, the contracting parties undertake to start fulfilling their contractual obligations immediately after this obstacle disappears. Each contracting party shall be obliged to inform immediately the other contracting party of the occurrence of the above obstacles.
- The followings are mainly considered to be vis major: natural events, arbitrary acts of third parties, strikes, work lockouts, blockades, wars (declared or undeclared), a change in the political situation or any other similar event which precludes or unduly impedes the exercise of rights and obligations under the contract.

VIII. PRIVACY POLICY

- The Buyer (for the purposes of this article also another person signed on the FPC and the order on behalf of the Buyer) expressly grants to the Seller, according to Act no. 428/2002 Coll. on personal data protection as amended (hereinafter referred to as the „Act“), consent to the processing of its personal data specified in the FPC and the Buyer's order.
- The Buyer expressly authorizes the Seller to process personal data for the purposes of:
 - exercise of the rights and obligations arising from the FPC and IPC,
 - keeping records, the obligation of which arises for the Seller by law or on the basis of the Act,
 - performing marketing activities.
- The Buyer expressly gives the Seller consent to provide the Buyer's personal data for the purposes stated in point 8.2 to a third party which has been entrusted by the Buyer with the activity in question.
- The Buyer expressly grants the Seller consent to the processing of personal data:
 - for the period in which the Seller is obliged to keep the records referred to in point 8.2. b /,
 - for the period in which it is necessary to protect the legal rights and legally protected interests of the Seller.
- The Buyer takes into account that it has the right to revoke its consent to the processing of personal data and require the liquidation of its personal data in the event that the Seller, or a third party to whom the Seller has provided personal data, respectively, breaches the obligations arising from the Act.

IX. FINAL PROVISIONS

- The Buyer is not entitled to transfer or assign the rights resulting for the Buyer from the FPC or IPC to a third party without the express consent of the Seller.
- The FPC may be amended, unless otherwise provided in these General Terms and Conditions, only in the form of written amendments signed by representatives of both the contracting parties.
- The agreed deviating provisions in the IPC between the Seller and the Buyer take precedence over the provisions of the FPC and these General Terms and Conditions. Legal relations that are not regulated in the FPC, IPC or in these General Terms and Conditions are governed by the Commercial Code and other generally binding legal regulations in force in the Slovak Republic, excluding the use of conflicting rules of law and the application of the UN Convention on Contracts for the International Sale of Goods /CISG/ of April 11, 1980 and their possible amendments in the case the Buyer has its registered office (place of business) in another state or the goods are delivered to another state.
- All disputes arising from the implementation of the content of the FPC will be resolved by the contracting parties through an amicable settlement. Disputes that cannot be resolved by mutual agreement are entitled to be resolved (exclusively) by the competent court in the Slovak Republic.
- These General Terms and Conditions are issued by the Seller pursuant to § 273 of the Commercial Code, with effect from January 1, 2017.