



SYSTEM RYNNOWY PÓŁOKRĄGLY



**CENNIK
2024**

ZAŁECANE CENY DETALICZNE



POWERFUL PARTNER FOR YOUR ROOF

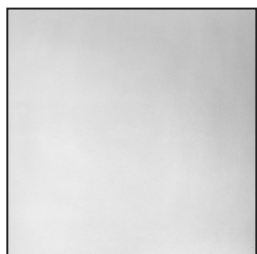

Material tytan-cynkowy | 3



Rynna | 6



Rynna dylatacyjna | 8



Rynna wyposażenie | 10



Hak połączeniowy | 11



Narożnik | 12



Denko rynny | 12



Wylot | 13



Kolano | 17



Rura spustowa | 18

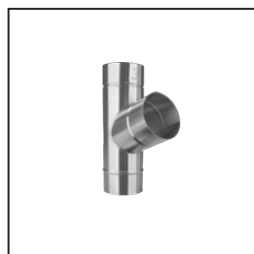

Rura spustowa wyposażenie | 20



Obejma rury | 21

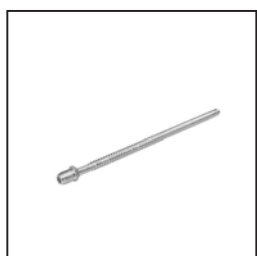

Obejma rury wyposażenie | 22



Rewizja rury spustowej | 25



Rura ochronna | 26

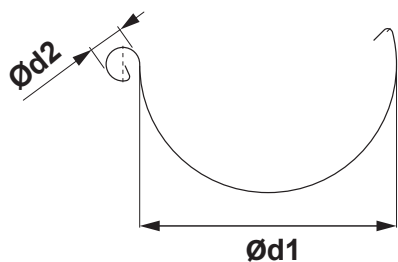

WYMIARY RYNIEN DACHOWYCH

(wymiary i tolerancje wymiarów według normy EN 612)

Szerokość w rozwinięciu (mm)	200	250	280	333	400	500
Ød1	80	105	127	153	192	250
Ød2	16	18	18	20	22	22

**SPAWANE
TIG**

**FALCOWANIE DO
WEWNĄTRZ**

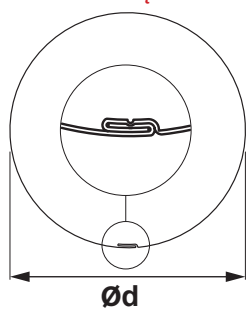
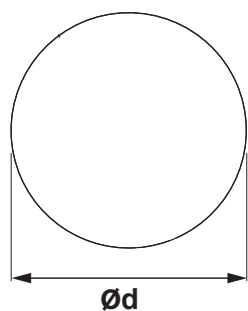

WYMIARY RYNIEN DACHOWYCH

(wymiary i tolerancje wymiarów według normy EN 612)

Wymiary	60	80	100	120	FALCOWANIE 150
Wielkość nominalna Ød (mm)	60	80	100	120	150

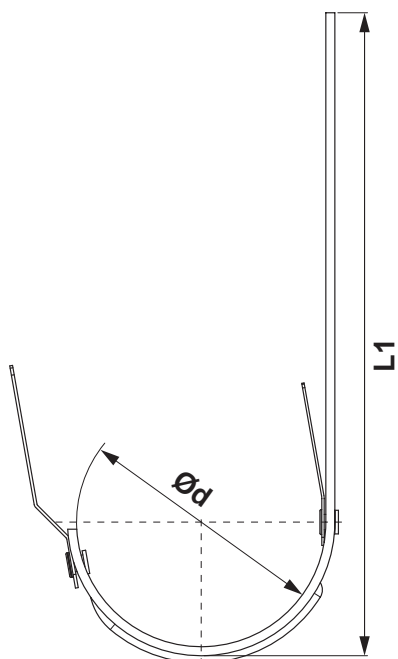

WYMIARY HAKÓW DACHOWYCH

(wymiary i tolerancje wymiarów według normy EN 612)

Wymiary (mm)	L1	Ød
200	290	80
250	310	105
280	345	127
333 – 550	385	153
333 – 610	445	153
400	400	192

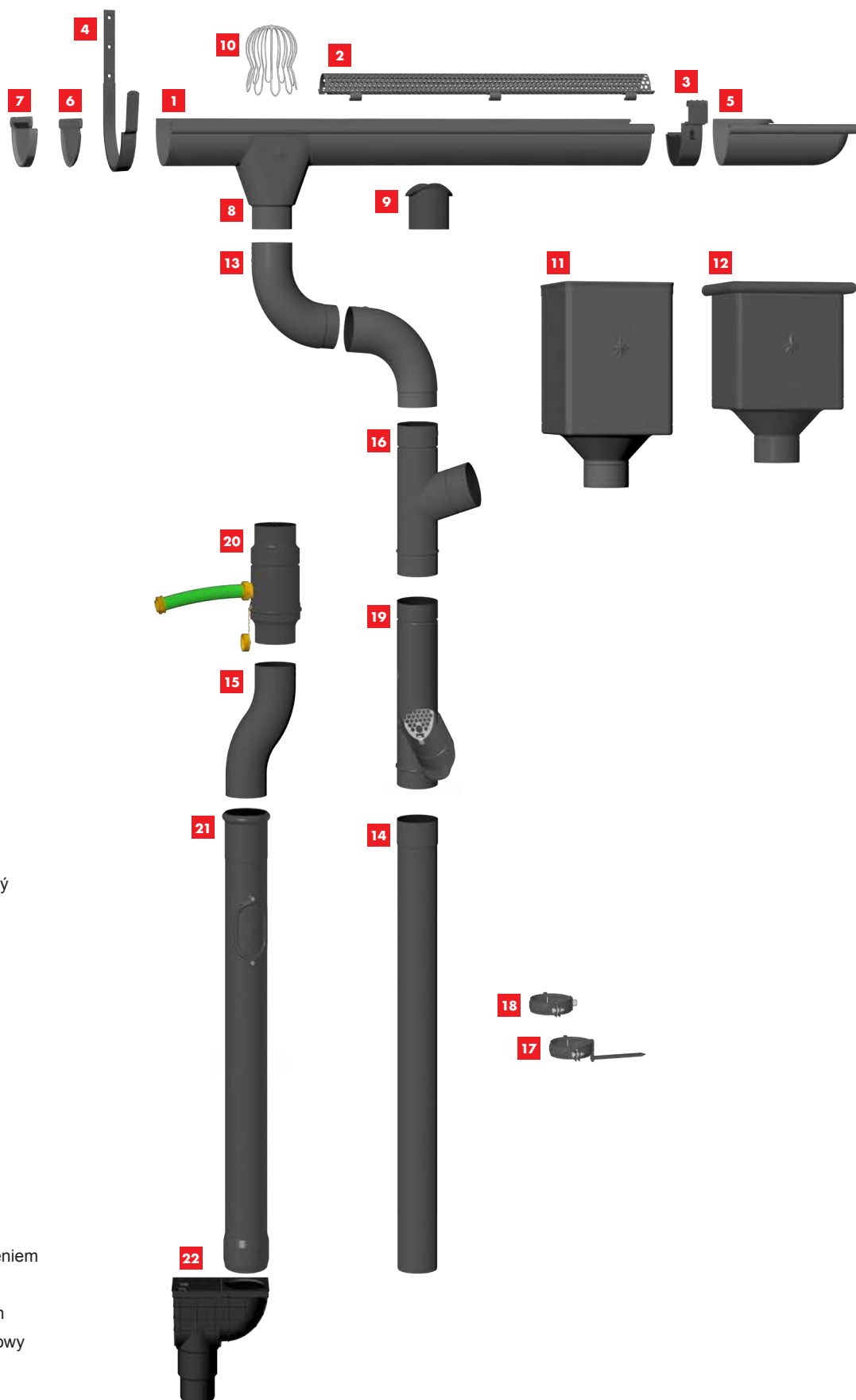

- 1** Rynna półokrągła
- 2** Kratka ochronna przed liśćmi
- 3** Łącznik rynny
- 4** Streśny žľabový hák obaľovaný
- 5** Narožník zvončrzný
- 6** Denko rynny
- 7** Denko rynny z gumą
- 8** Wylot
- 9** Sztucer
- 10** Sito-łapacz liści
- 11** Kosz zlewowy DESIGN
- 12** Kosz zlewowy KUBICZNY
- 13** Kolano
- 14** Rura spustowa
- 15** Odsadzka
- 16** Trójnik
- 17** Obejma rury spustovej z trzpieniem
- 18** Obejma rury z gwintem M10
- 19** Rewizja rury spustovej z sitem
- 20** Zbiornik na wodę+wąż plastikowy
- 21** Ura ochronna z rew.
- 22** Wyjście kanalizacyjne



TYTAN-CYNK





RYNNA PÓŁOKRĄGŁA [s=0,65 mm]

TZ-TZZ





TYTAN-CYNK

Rozmiar nominalny	Długość w m	EAN numer produktu	Pakowanie w m		Cena z VAT [ZŁ/m]
					
200	3,0	047939	15	1 200	47,70
250	2,0	047946	10	480	45,50
250	3,0	047960	15	720	42,70
250	4,0	047984	20	960	42,70
250	5,0	047991	25	1 200	42,70
250	6,0	048004	30	1 440	42,70
280	2,0	048028	10	420	50,40
280	3,0	048042	15	630	47,70
280	4,0	048066	20	840	47,70
280	5,0	048080	25	1 050	47,70
280	6,0	048097	30	1 260	47,70
333	2,0	048103	10	330	56,00
333	3,0	048127	15	495	53,50
333	4,0	048141	20	660	53,50
333	5,0	048165	25	825	53,50
333	6,0	048196	30	990	53,50
400	4,0	048219	20	540	73,80
400	6,0	048233	30	810	73,80



RYNNA PÓŁOKRĄGŁA [s=0,70 mm]

TZ-TZZ



Rozmiar nominalny	Długość w m	EAN numer produktu	Pakowanie w m		Cena z VAT [ZŁ/m]
					
500 *	4,0	048257	20	–	140,80

* Produkcja na zamówienie



RYNNA PÓŁOKRĄGŁA [s=0, 60 mm]

TZ-TZZ



Rozmiar nominalny	Długość w m	EAN numer produktu	Pakowanie w m		Cena z VAT [ZŁ/m]
					
250 *	3,0	047953	15	720	44,60
250 *	4,0	047977	20	960	44,60
333 *	3,0	048110	15	495	58,40
333 *	4,0	048134	20	660	58,40
333 *	5,0	048158	25	825	58,40
333 *	6,0	048189	30	990	58,40

* Produkcja na zamówienie



RYNNA LEŻĄCA

TZ-TZZS

Rozmiar nominalny	Długość w m	EAN numer produktu	Pakowanie w m		Cena z VAT [ZŁ/m]
					
650	4,0	000439	4	200	191,30

* Produkcja na zamówienie

RYNNA DYLATACYJNA

TZ-TZZDI

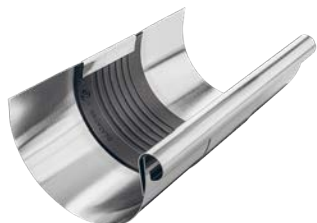

Rozmiar nominalny	EAN numer produktu	Pakowanie w szt.		Cena z VAT [ZŁ/szt.]
250/260	082688	3	360	83,00
280/260	082695	3	360	84,30
333/260	082701	5	200	84,30
400/260	082718	5	200	108,20



DYLATACJA RYNNY LEŻĄCEJ

TZ-TZZSDI

Rozmiar nominalny	EAN numer produktu	Pakowanie w szt.		Cena z VAT [ZŁ/szt.]
670/260	082725	1	40	224,50



PAS DYLATACYJNY

TZ-TZZDIP

Rozmiar nominalny	Długość w m	EAN numer produktu	Pakowanie w m		Cena z VAT [ZŁ/m]
260	3,0	028020	3	120	276,80
260	6,0	028037	6	240	276,80

ZASTOSOWANIE RYNNY DYLATACYJNEJ I DYLATACJI TAŚMOWEJ

RYNNA DYLATACYJNA

Przykładowy montaż: Rynna podokapowa o szerokości w rozwinięciu do 500 mm. Rynnę dylatacyjną należy montować w odstępach co 15 m. Dla naroża zewnętrznego i początku rynny obowiązuje połowiczna wartość wartości standardowej: maksymalnie 7,5 m. Dla naroża zewnętrznego obowiązuje jedna czwarta wartości standardowej: maksymalnie 3,75 m. Dla pozostałych materiałów i wymiarów: patrz tabela poniżej. Naroża uwzględnianie są zawsze jako stałe punkty odniesienia.

DACHOWE: RYNNY DYLATACYJNE PÓŁOKRĄGŁE

Szerokość w rozwinięciu rynny	Aluminium	Ocynkowane, Tytan-cynk, Miedź, Stal nierdzewna
< 500	12	15
> 500	8	10

DYLATACJA TAŚMOWA

Instalacja wewnętrzna: dla rynien przymocowanych bez klejenia do podkładu, dachy o profilu niestandardowym i obudową muru blachami metalowymi.

DACHOWA: DYLATACJA TAŚMOWA

Szerokość w rozwinięciu rynny	Aluminium	Ocynkowane, Tytan-cynk, Miedź, Stal nierdzewna
< 500	8	10
> 500	6	8

Dla naroża zewnętrznego obowiązuje połowa wartości standardowej. Dla naroża wewnętrznego obowiązuje jedna czwarta wartości standardowej.

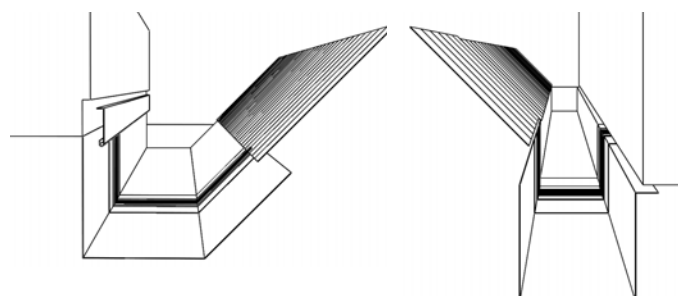
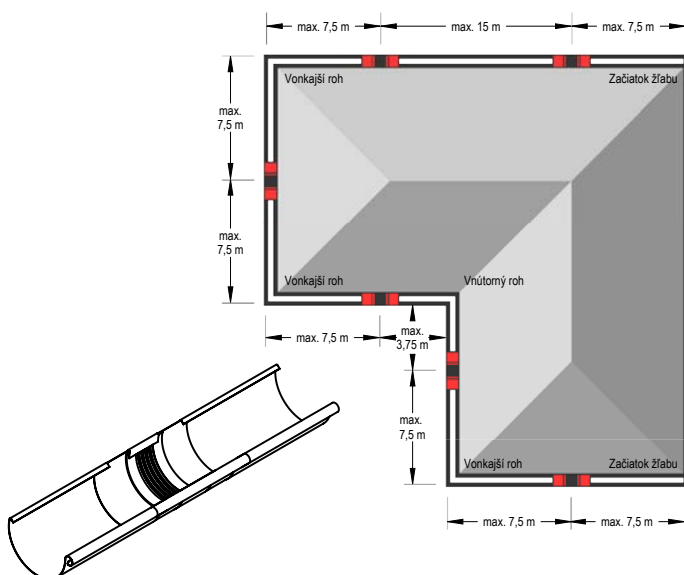

Uwaga dotycząca montażu taśmy dylatacyjnej
Przed wykonaniem procesu gięcia i montażu elementów dylatacyjnych należy upewnić się, czy:

- Szczęki gięcia mają minimalny promień wartości 2 mm.
- Dla blach grubości powyżej 1 mm należy dotrzymywać minimalny promień gięcia wartości 5 mm.
- Szczęki gięcia należy ustawić na grubość środkowej części gumowej o wartości od 3 do 4 mm, aby zapobiec efektowi strzyżenia – uszkodzeniu gumy.
- Środkowa część gumowa przeznaczona do gięcia nie może być pofalowana lub uszkodzona. Z tego względu powinno się stosować taśmę aluminiową grubości od 2 mm do 5 mm wygiętą tak, aby można ją przymocować jako ochronę szczęk służących do gięcia. W ten sposób można zwiększyć promień gięcia i zapobiec przesunięciu się środkowej części gumowej.

Uwaga dotycząca montażu rynny dylatacyjnej.

W trakcie montażu za pomocą lutowni środkowy element gumowy najpierw należy przykryć mokrą szmatką (aby nie doszło do przeniesienia energii cieplnej do środkowego elementu gumowego). Wymagane jest dotrzymanie minimalnej odległości 6 cm od środkowego elementu gumowego. W każdym przypadku trzeba uniknąć kontaktu gumy z otwartym ogniem (płomieniem).



ALUMINIUM KRATKA OCHRONNA PRZED LIŚĆMI

W-WZNLM

Rozmiar nominalny	Dłżka v m	EAN numer produktu	Pakowanie w szt.		Cena z VAT [ZŁ/szt.]
333	2,0	064905	25	300	156,80

PVC LAPAĆ LIŚCIA

SD-ZNL MRIEZKA

Rozmiar nominalny	Długość w m	EAN numer produktu	Pakowanie w szt.		Cena z VAT [ZŁ/szt.]
171	1,0	008473	30	450	27,70
171	1,0	008466	30	450	27,70

PVC LAPAĆ LIŚCIA

SD-ZNL N

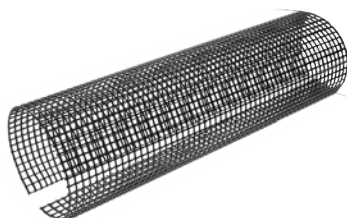

Rozmiar nominalny	Długość w m	EAN numer produktu	Pakowanie w szt.		Cena z VAT [ZŁ/szt.]
250	3,0	008480	10	400	147,00
280-333	3,0	008497	10	400	147,60





ŁĄCZNIK RYNNY

TZ-TZSPZ



Rozmiar nominalny	EAN numer produktu	Pakowanie w szt.		Cena z VAT [ZŁ/szt.]
				
250 *	102454	5	600	W PROCESIE TESTÓW
280 *	102461	5	600	W PROCESIE TESTÓW
333 *	102478	5	600	W PROCESIE TESTÓW

* Produkcja na zamówienie



ŻŁABOVÝ HÁK OBALOVANÝ

TZ-TZHOB



Rozmiar nominalny	Materiał	EAN numer produktu	Pakowanie w szt.		Cena z VAT [ZŁ/szt.]
					
200/380	25/6	032805	10	1 000	27,10
250/430	25/6	032812	10	1 000	21,50
280/480	25/6	032829	10	1 000	23,40
333/550	25/6	032836	10	1 000	24,60
333/610	25/6	032843	10	1 000	29,20
400/650	25/6	032850	10	500	39,10

TYTAN-CYNK



HÁK DO RYNNY LEŻĄCEJ Z PODPACIEM



TZ-TZHOBSSN

Rozmiar nominalny	Materiał	EAN numer produktu	Pakowanie w szt.		Cena z VAT [ZŁ/szt.]
					
4	25/6	000910	15	300	106,40

NAROŻNIK ZEWNĘTRZNY

TZ-TZRA





Rozmiar nominalny	EAN numer produktu	Pakowanie w szt.		Cena z VAT [ZŁ/szt.]
				
200	000811	5	150	92,30
250	000828	5	150	92,30
280	000835	5	150	102,10
333	000842	5	150	102,10
400	000859	5	150	202,30

NAROŻNIK WEWNĘTRZNY

TZ-TZRI





Rozmiar nominalny	EAN numer produktu	Pakowanie w szt.		Cena z VAT [ZŁ/szt.]
				
200	000866	5	150	92,30
250	000873	5	150	92,30
280	000880	5	150	102,10
333	000897	5	150	102,10
400	000903	5	150	202,30

DENKO RYNNY

TZ-TZCL





Rozmiar nominalny	EAN numer produktu	Pakowanie w szt.		Cena z VAT [ZŁ/szt.]
				
200	001665	6/60	1 440	4,90
250	001672	50	4 500	4,30
280	001689	50	4 500	4,90
333	001696	50	4 500	5,80
400	001702	4/40	960	9,50

DENKO RYNNY Z GUMĄ

TZ-TZCLG





Rozmiar nominalny	EAN numer produktu	Pakowanie w szt.		Cena z VAT [ZŁ/szt.]
				
250 *	004390	25	2 250	W PROCESIE TESTÓW
280 *	004406	25	2 250	W PROCESIE TESTÓW
333 *	004413	25	2 250	W PROCESIE TESTÓW

* Produkcja na zamówienie

WYLOT

TZ-TZKL



Rozmiar nominalny	EAN numer produktu	Pakowanie w szt.		Cena z VAT [ZŁ/szt.]
				
200/60	003775	20	600	53,50
250/60	003782	20	600	49,80
250/80	003799	20	600	40,00
280/80	003805	20	600	50,10
280/100	003812	20	600	46,10
333/80	003829	20	600	61,50
333/100	003836	20	600	50,40
333/120	003843	15	300	70,70
400/100	003850	15	300	98,40
400/120	003867	15	300	108,90
400/150	003874	15	300	129,20

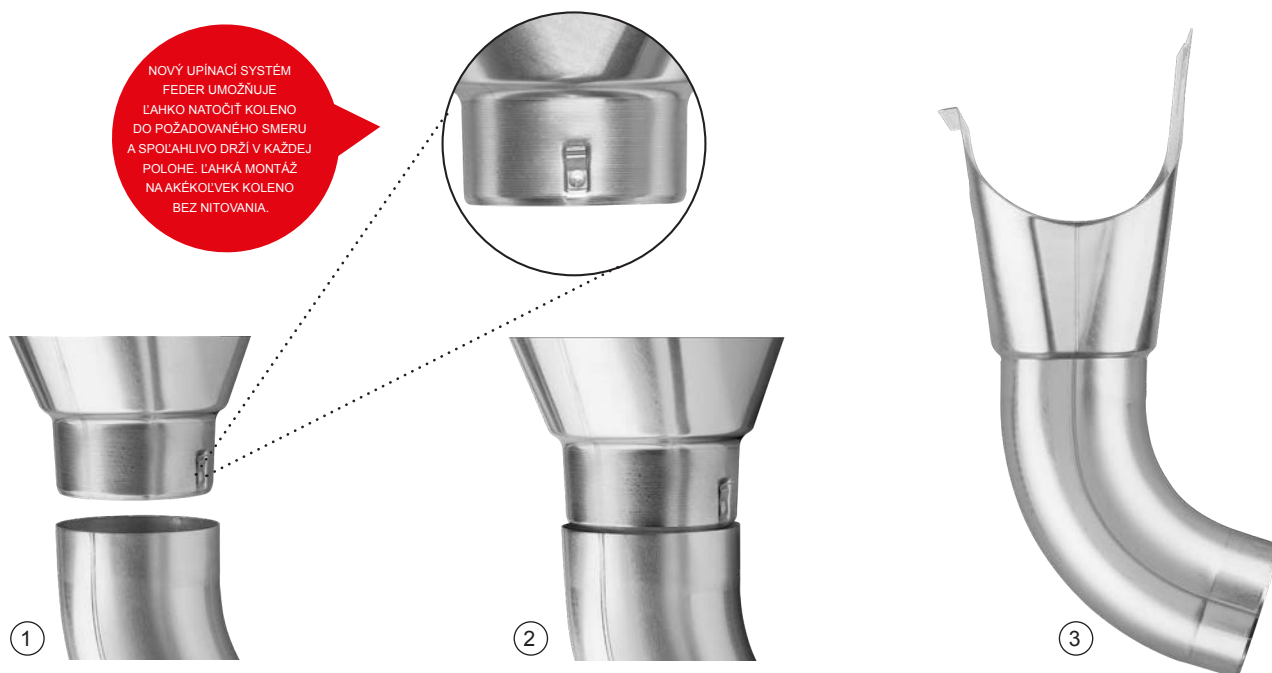

SZTUCER

TZ-TZHRD



Rozmiar nominalny	EAN numer produktu	Pakowanie w szt.		Cena z VAT [Zł/szt.]
80	102539	40	1 000	14,10
100	102546	25	1 000	16,00
120	102553	15	750	21,50

SITO-ŁAPACZ LIŚCI STAL NIERDZEWNA

N-NZN





Rozmiar nominalny	EAN numer produktu	Pakowanie w szt.		Cena z VAT [Zł/szt.]
60	001153	30	2 160	34,10
80	001160	20	1 440	34,40
100	001177	15	1 080	35,10
120	001184	10	720	38,10
150	001191	5	360	60,30



KOSZ ZLEWOWY DESIGN

TZ-TZKLZ DE





Rozmiar nominalny	EAN numer produktu	Pakowanie w szt.		Cena z VAT [ZŁ/szt.]
				
80	007834	2	36	399,80
100	007858	2	36	399,80
120	007872	2	36	405,90

KOSZ ZLEWOWY DESIGN EKSCENTRYCZNY

TZ-TZKLZ DX





Rozmiar nominalny	EAN numer produktu	Pakowanie w szt.		Cena z VAT [ZŁ/szt.]
				
80 *	007896	2	36	461,30
100	007926	2	36	461,30
120	007957	2	36	470,50

* Produkcja na zamówienie

KOSZ ZLEWOWY KUBICZNY

TZ-TZKLZ KU





Rozmiar nominalny	EAN numer produktu	Pakowanie w szt.		Cena z VAT [ZŁ/szt.]
				
80 *	007841	2	36	597,80
100	007865	2	36	597,80
120	007889	2	36	597,80

* Produkcja na zamówienie

KOSZ ZLEWOWY KUBICZNY EXZENTRYCKÝ

TZ-TZKLZ KX





Rozmiar nominalny	EAN numer produktu	Pakowanie w szt.		Cena z VAT [ZŁ/szt.]
				
80	007902	2	36	602,70
100	007933	2	36	602,70
120	007964	2	36	615,00

KOSZ ZLEWOWY KUBICZNY EKSCENTRYCZNY Z RURĄ

TZ-TZKLZ KXV





Rozmiar nominalny	EAN numer produktu	Pakowanie w szt.		Cena z VAT [ZŁ/szt.]
				
80	007919	2	36	842,60
100	007940	2	36	842,60
120	007971	2	36	848,70

USZCZELKA GUMOWA DO KOSZA ZLEWOWEGO

P-PKLZ T



Rozmiar nominalny	EAN numer produktu	Pakowanie w szt.		Cena z VAT [ZŁ/szt.]
				
IC 70-85	077103	5	600	24,60
IC 100-110	077110	5	600	25,20
IC 110-125	077097	5	600	25,80
PS 70-85	077134	5	600	27,70
PS 100-110	077141	5	600	30,10
PS 110-125	077127	5	600	30,80

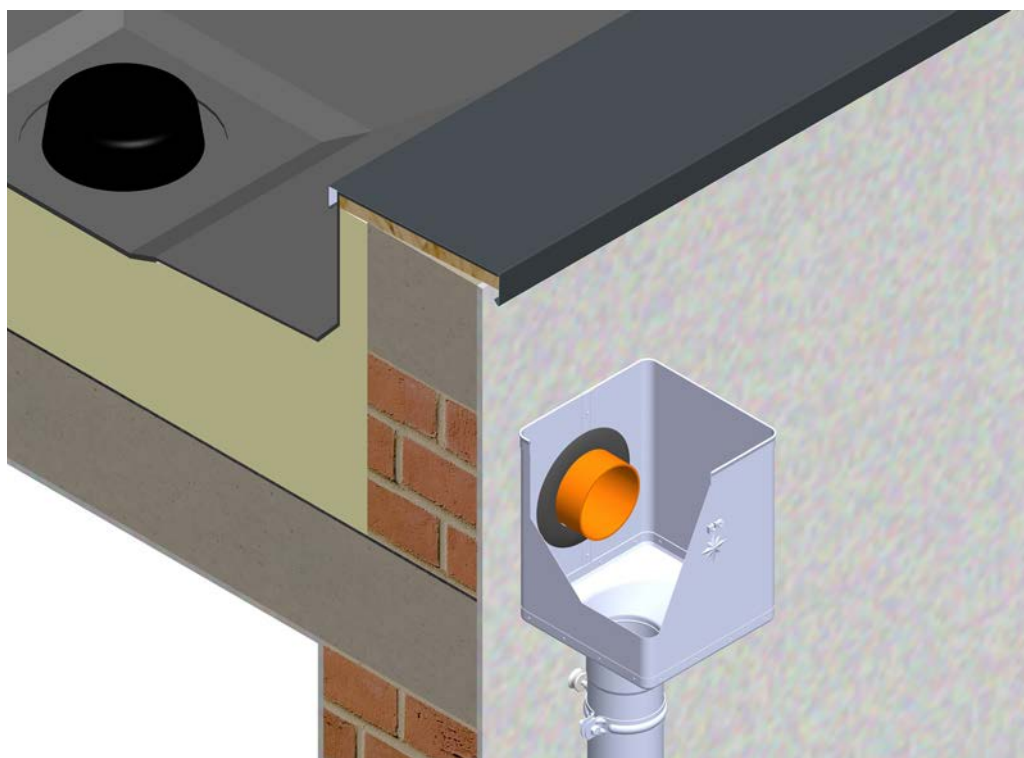

KOLANO 72°

TZ-TZK



Rozmiar nominalny	EAN numer produktu	Pakowanie w szt.		Cena z VAT [ZŁ/szt.]
60	083081	25	600	37,50
80	083098	25	400	27,40
100	083111	25	300	32,00
120	083135	15	180	68,90
150	083159	5	90	239,90

KOLANO PROMIEN 85°

TZ-TZKR



Rozmiar nominalny	EAN numer produktu	Pakowanie w szt.		Cena z VAT [ZŁ/szt.]
80	083104	25	400	48,00
100	083128	25	300	51,00
120	083142	15	180	112,50

TYTAN-CYNK

KOLANO TĘPE 40°

TZ-TZKT





Rozmiar nominalny	EAN numer produktu	Pakowanie w szt.		Cena z VAT [ZŁ/szt.]
80	083166	25	400	33,20
100	083173	25	300	42,40
120	083180	15	240	83,00

RURA SPUSTOWA [s=0,65 mm]

TZ-TZZR





Rozmiar nominalny	Długość w m	EAN numer produktu	Pakowanie w m		Cena z VAT [ZŁ/m]
					
60	2,0	047618	2	490	42,40
60	3,0	047625	3	735	42,40
80	1,0	047649	10	100	46,70
80	2,0	047663	2	250	44,90
80	3,0	047687	3	375	44,90
80	4,0	047694	4	500	44,90
80 *	5,0	047700	5	625	44,90
80 *	6,0	047717	6	750	44,90
100	1,0	047731	10	70	56,60
100	2,0	047755	2	160	54,70
100	3,0	047779	3	240	54,70
100	4,0	047793	4	320	54,70
100 *	5,0	047816	5	400	54,70
100 *	6,0	047823	6	480	54,70
120	1,0	047830	8	48	72,30
120	2,0	047847	2	120	69,50
120	3,0	047854	3	180	69,50
120	4,0	047878	4	240	69,50
120 *	5,0	047892	5	300	69,50
120 *	6,0	047908	6	360	69,50

* Produkcja na zamówienie



RURA SPUSTOWA [s=0,70 mm]

TZ-TZZR



Rozmiar nominalny	Długość w m	EAN numer produktu	Pakowanie w m		Cena z VAT [ZŁ/m]
					
150 ¹	4,0	047922	4	112	152,50

¹ Falcowanie do wewnątrz



RURA SPUSTOWA [s=0, 60 mm]

TZ-TZZR



Rozmiar nominalny	Długość w m	EAN numer produktu	Pakowanie w m		Cena z VAT [ZŁ/m]
					
80 *	1,0	047632	10	100	48,00
80 *	2,0	047656	2	250	48,00
80 *	3,0	047670	3	375	47,40
80 *	4,0	081742	4	500	47,40
80 *	5,0	081759	5	625	47,40
80 *	6,0	081766	6	750	47,40
100 *	1,0	047724	10	70	59,00
100 *	2,0	047748	2	160	59,00
100 *	3,0	047762	3	240	58,40
100 *	4,0	047786	4	320	58,40
100 *	5,0	047809	5	400	58,40
100 *	6,0	081773	6	480	58,40

* Produkcja na zamówienie



PLASTIKOWY RĘKAW RURY SPUSTOWEJ

SD-ZR FOLIA KJG

Rozmiar nominalny	Długość w m	EAN numer produktu	Pakowanie w m		Cena z VAT [ZŁ/m]
					
60-150	100,0	139726	100	6 000	2,30



ODSADZKA

TZ-TZKO

Rozmiar nominalny	EAN numer produktu	Pakowanie w szt.		Cena z VAT [Zł/szt.]
80	047380	20	320	56,60
100	047397	20	240	68,90
120	047403	15	180	129,20

TRÓJNIK 72°

TZ-TZZO

Rozmiar nominalny	EAN numer produktu	Pakowanie w szt.		Cena z VAT [Zł/szt.]
80/80	102560	4	90	103,30
100/60	102577	4	120	110,70
100/80	102584	4	120	110,70
100/100	102591	4	120	110,70
120/80	102607	3	90	137,80
120/100	102614	3	90	137,80
120/120	102621	3	90	137,80
150/120 *	102638	2	36	223,90
150/150 *	102645	2	36	242,90

* Produkcja na zamówienie

OBEJMA RURY SPUSTOVEJ Z TRZPIENIEM 150 mm

TZ-TZO



Rozmiar nominalny	EAN numer produktu	Pakowanie w szt.		Cena z VAT [ZŁ/szt.]
80	008503	25	1 000	18,50
100	008510	25	1 000	20,30
120	008527	25	1 000	21,50

OBEJMA RURY SPUSTOVEJ Z TRZPIENIEM 200 mm

TZ-TZOD



Rozmiar nominalny	EAN numer produktu	Pakowanie w szt.		Cena z VAT [ZŁ/szt.]
80	008534	25	1 000	19,70
100	008541	25	1 000	21,20
120	008558	25	1 000	22,40

OBEJMA RURY SPUSTOVEJ Z TRZPIENIEM 300 mm

TZ-TZODD



Rozmiar nominalny	EAN numer produktu	Pakowanie w szt.		Cena z VAT [ZŁ/szt.]
100	008572	20	800	22,80
120	008589	20	800	25,20

OBEJMA RURY SPUSTOVEJ Z GWINETEM M10



TZ-TZOB



Rozmiar nominalny	EAN numer produktu	Pakowanie w szt.		Cena z VAT [ZŁ/szt.]
60	000132	25	3 000	24,30
80	000149	25	3 000	18,50
100	000156	25	3 000	19,70
120	000163	25	3 000	22,80
150	000170	20	2 400	30,80

STAL NIEREDZAWNA ŚRUBA DO OBEJMY RURY M6x20 P-POB-NSK





Rozmiar nominalny	EAN numer produktu	Pakowanie w szt.		Cena z VAT [ZŁ/szt.]
				
M6 x 20 *	071675	1	–	0,90

* Produkcja na zamówienie

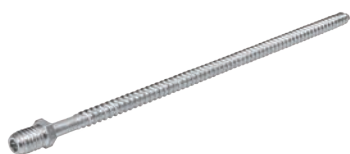
SZTYFT DO OBEJMY Z NAKRĘTKĄ GWINTOWANĄ TORX M10 P-POB-HT





TYTAN-CYNK

Rozmiar nominalny	EAN numer produktu	Pakowanie w szt.		Cena z VAT [ZŁ/szt.]
				
80	002464	100	40 000	6,20
140	002471	100	28 000	7,70
200	002488	100	20 000	9,50
250	002495	100	16 000	10,50
300	002501	100	11 200	10,50



KOŁEK M10 P-POB-HN DB



Rozmiar nominalny	EAN numer produktu	Pakowanie w szt.		Cena z VAT [ZŁ/szt.]
				
120	002426	100	25 000	2,50



KOŁEK Z LAMELĄ M10 P-POB-HN DB



Rozmiar nominalny	EAN numer produktu	Pakowanie w szt.		Cena z VAT [ZŁ/szt.]
				
180	002433	100	12 000	2,60
240	002440	100	12 000	3,10
280	002457	100	12 000	3,30

WKRĘT KOMBI TORX M10 P-POB-ZT/SZ



Rozmiar nominalny	EAN numer produktu	Pakowanie w szt.		Cena z VAT [ZŁ/szt.]
				
140	002587	50	10 400	2,80
180	002594	50	10 400	3,40

KOLEK DO IZOLACJI M10

P-POB-HN IZOL



Rozmiar nominalny	EAN numer produktu	Pakowanie w szt.		Cena z VAT [ZŁ/szt.]
M10 x 96	001207	25	2 625	16,60

KOLEK IZOLACYJNY KOŃCÓWKA CEGŁA BEZ IZOLACJI P-POB-HN WDVS140 M10



Rozmiar nominalny	EAN numer produktu	Pakowanie w szt.		Cena z VAT [ZŁ/szt.]
140	144843	1/5	750	29,50

KOLEK IZOLACYJNY KOŃCÓWKA DO CEGŁY Z IZOLACJĄ P-POB-HN WDVS300 M10



Rozmiar nominalny	EAN numer produktu	Pakowanie w szt.		Cena z VAT [ZŁ/szt.]
300	144850	1/5	500	48,00

PLATFORMA UNI ZE STALI NIERDZEWNEJ DO MOCOWANIA OB M10 P-POB-HN PLAT M10



Rozmiar nominalny	EAN numer produktu	Pakowanie w szt.		Cena z VAT [ZŁ/szt.]
M10	144836	25/500	5 000	20,60

PRĘT GWINTOWANY M10

P-POB-ZT



Rozmiar nominalny	EAN numer produktu	Pakowanie w szt.		Cena z VAT [Zł/szt.]
60	002556	100	20 800	1,20
100	002563	100	15 600	1,80
150	002570	50	10 400	3,40

STOPKA OBEJMY RURY SPUSTOWEJ M10

P-POB-ZT MP



Rozmiar nominalny	EAN numer produktu	Pakowanie w szt.		Cena z VAT [Zł/szt.]
80 x 30	002518	25	5 200	7,10

NAKŁADKA DO SZTYFTU DO OBEJMY

P-POB-HT AKG



Rozmiar nominalny	EAN numer produktu	Pakowanie w szt.		Cena z VAT [Zł/szt.]
29 x 13	002280	50	16 800	1,50
29 x 13	002211	50	16 800	1,50
29 x 13	002235	50	16 800	1,50
29 x 13	002266	50	16 800	1,50
29 x 13	002242	50	16 800	1,50
29 x 13	002228	50	16 800	1,50
29 x 13	002273	50	16 800	1,50
29 x 13	002259	50	16 800	1,50
29 x 13	002297	50	16 800	1,50



REWIZJA RURY SPUSTOWEJ

TZ-TZZV



Rozmiar nominalny	EAN numer produktu	Pakowanie w szt.		Cena z VAT [ZŁ/szt.]
80	035011	6	180	65,20
100	035028	5	150	80,00
120	035035	3	90	102,10

REWIZJA RURY SPUSTOWEJ Z SITEM

TZ-TZZVS



Rozmiar nominalny	EAN numer produktu	Pakowanie w szt.		Cena z VAT [ZŁ/szt.]
80	034984	6	180	80,00
100	034991	5	150	91,60
120	035004	3	90	153,80

TYTAN-CYNK

ZBIORNIK NA WODĘ+WĄŻ PLASTIKOWY

TZ-TZZVHA



Wymiar: 80, 120

Wymiar: 100

Rozmiar nominalny	EAN numer produktu	Pakowanie w szt.		Cena z VAT [ZŁ/szt.]
80	001450	1	60	369,00
100	001467	1	60	387,50
120	001474	1	60	608,90



OCYNKOWANA STAL RURA OCHRONNA Z REW.POW

P-POZR

Rozmiar nominalny	Długość w m	EAN numer produktu	Pakowanie w szt.		Cena z VAT [ZŁ/szt.]
80	1,0	009708	1	70	369,00
100	1,0	009715	1	60	276,80
100	1,5	009722	1	60	547,40



OCYNKOWANA STAL RURA OCHRONNA Z REW.POW

P-POZR

Rozmiar nominalny	Długość w m	EAN numer produktu	Pakowanie w szt.		Cena z VAT [ZŁ/szt.]
120	1,0	009739	1	40	645,80
120	1,5	009746	1	40	879,50

TYTAN-CYNK



OBEJMA Z GUMĄ OCHRONNĄ M10

P-POB-OZR

Rozmiar nominalny	EAN numer produktu	Pakowanie w szt.		Cena z VAT [ZŁ/szt.]
80	002525	25	1 250	9,50
100	002532	25	1 250	12,30
120	002549	20	1 000	13,80

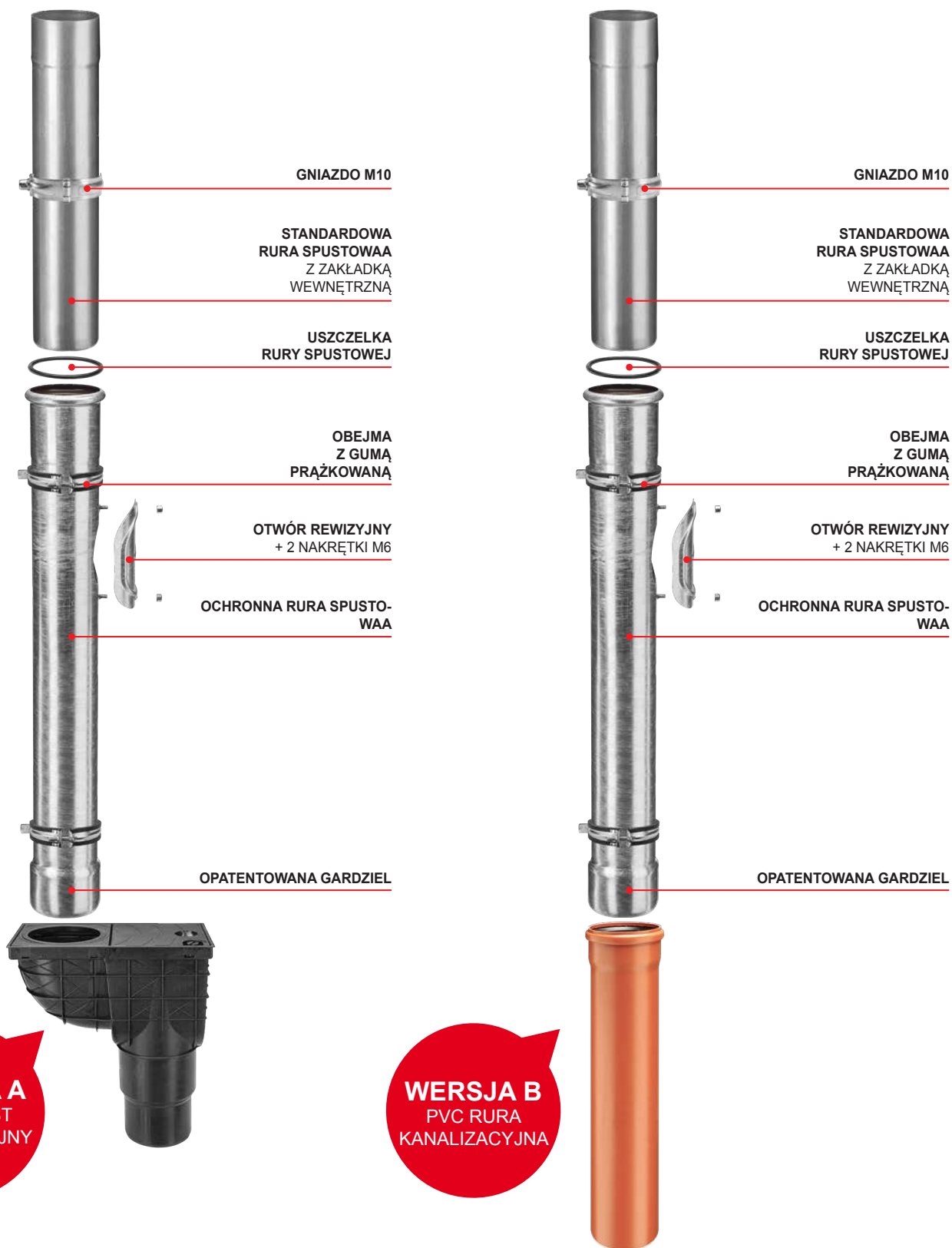

WERSJA A
PVC WPUST
KANALIZACYJNY

WERSJA B
PVC RURA
KANALIZACYJNA

