



ŽLEBNI SISTEM POLKROŽNI



**CENIK
2024**

PRIPOROČENA PRODAJNA CENA



POWERFUL PARTNER FOR YOUR ROOF

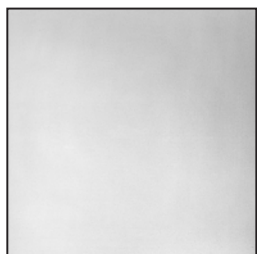

Cinkotit material | 3



Žleb | 6



Strešni dilatcijski žleb | 8



Žleb oprema | 10



Kljuka | 11



Vogalnik | 12



Zaključek žleba | 12



Kotliček | 13



Koleno | 17



Cev odvodna | 18

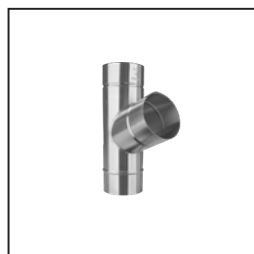

Cev odvodna oprema | 20



Objemka | 21

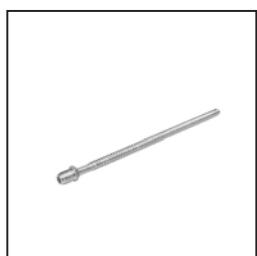

Objemka oprema | 22



Lovilec vode | 25



Zaščitna cev | 26

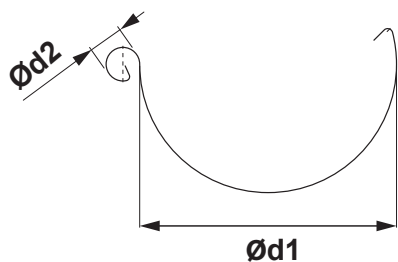

DIMENZIJE STREŠNIH ŽLEBOV

(dimenzije in toleranca po EN 612)

Razvita širina (mm)	200	250	280	333	400	500
Ød1	80	105	127	153	192	250
Ød2	16	18	18	20	22	22

VARJENE TIG

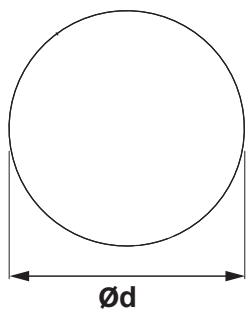

NOTRANJI ZGIB

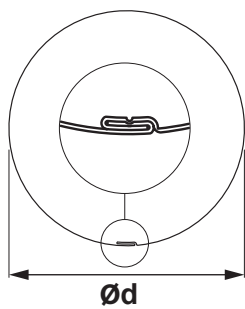

DIMENZIJE STREŠNIH ODOČNIH CEVI

(dimenzije in toleranca po EN 612)

Dimenzije	60	80	100	120	NOTRANJI ZGIB 150
Imenska velikost Ød (mm)	60	80	100	120	150

DIMENZIJE STREŠNIH KAVLJEV

(dimenzije in toleranca po EN 612)

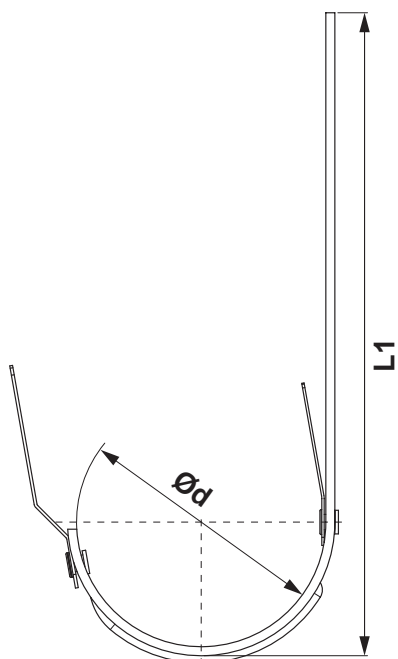

Dimenzije (mm)	L1	Ød
200	290	80
250	310	105
280	345	127
333 – 550	385	153
333 – 610	445	153
400	400	192

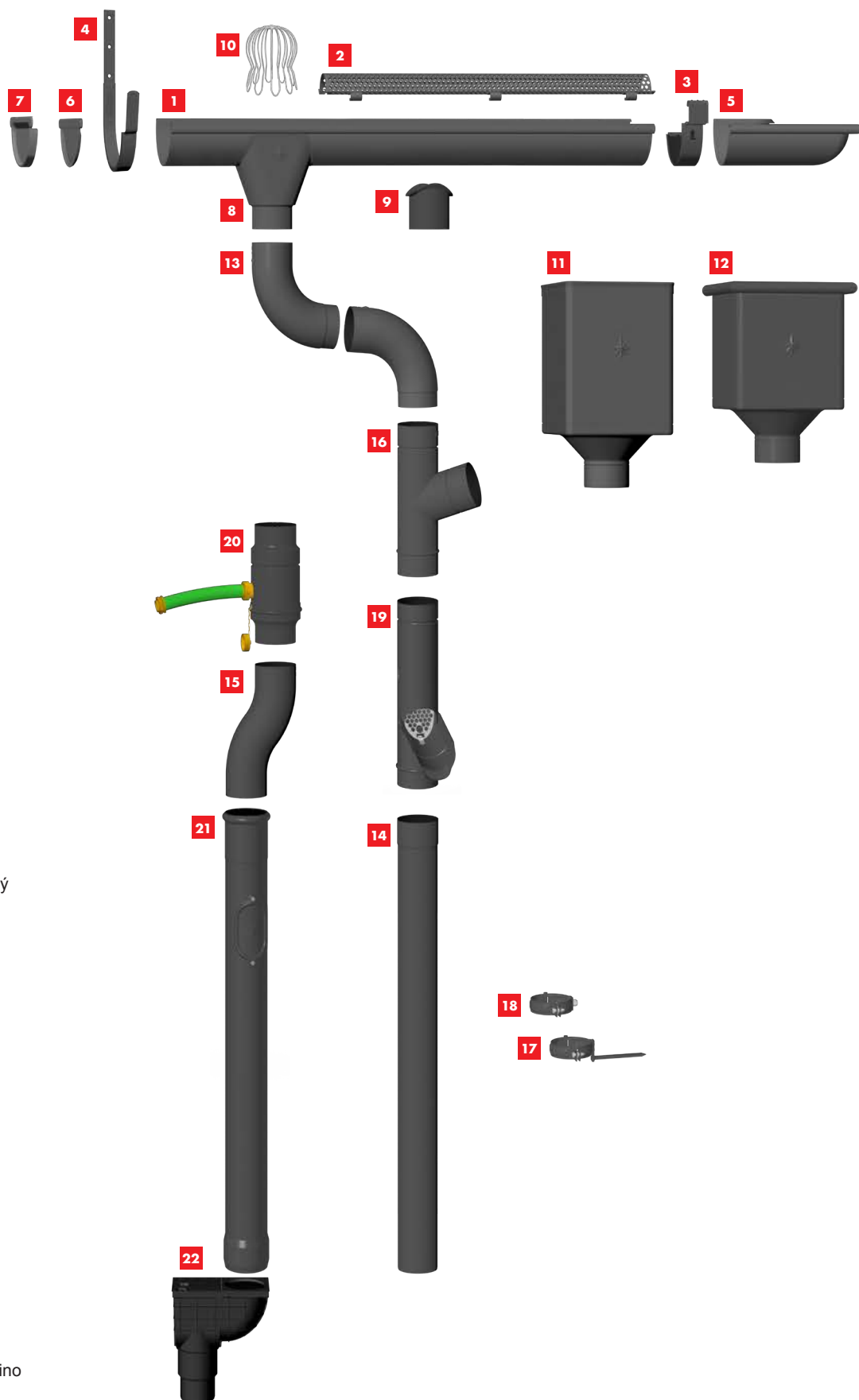

- 1** Žleb polkrožni
- 2** Mreža za lovljenje nesnaget
- 3** Spojka žleba
- 4** Strešny žlabový hák obaloovaný
- 5** Vogalnik notranji
- 6** Zaključek žleba
- 7** Zaključek z gumo
- 8** Kotliček
- 9** Grlo
- 10** Lovilec nesnage
- 11** Zbirni kotliček DESIGN
- 12** Zbirni kotliček KUBICKI
- 13** Koleno
- 14** Cev odvodna
- 15** Koleno izogibno
- 16** Redukcija cevi
- 17** Objemka z žebļjem
- 18** Objemka z navojem M10
- 19** Lovilec vode s sitom
- 20** Lovilec vode s cevjo
- 21** Zaščitna cev z revizijsko odprtino
- 22** Peskolov črni-raven spust





CINKOTIT



ŽLEB POLKROŽNI [s=0,65 mm]

TZ-TZZ

Nominalna velikost	Dolžina v m	EAN številko izdelka	Pakiranje v m		Cena [€/m]	
					Brez DDV	Z DDV
200	3,0	047939	15	1 200	7,75	9,46
250	2,0	047946	10	480	7,40	9,03
250	3,0	047960	15	720	6,95	8,48
250	4,0	047984	20	960	6,95	8,48
250	5,0	047991	25	1 200	6,95	8,48
250	6,0	048004	30	1 440	6,95	8,48
280	2,0	048028	10	420	8,20	10,00
280	3,0	048042	15	630	7,75	9,46
280	4,0	048066	20	840	7,75	9,46
280	5,0	048080	25	1 050	7,75	9,46
280	6,0	048097	30	1 260	7,75	9,46
333	2,0	048103	10	330	9,10	11,10
333	3,0	048127	15	495	8,70	10,61
333	4,0	048141	20	660	8,70	10,61
333	5,0	048165	25	825	8,70	10,61
333	6,0	048196	30	990	8,70	10,61
400	4,0	048219	20	540	12,00	14,64
400	6,0	048233	30	810	12,00	14,64





CINKOTIT



ŽLEB POLKROŽNI [s=0,70 mm]

TZ-TZZ



Nominalna velikost	Dolžina v m	EAN številko izdelka	Pakiranje v m		Cena [€/m]	
					Brez DDV	Z DDV
500 *	4,0	048257	20	–	22,90	27,94

* Izdelava po meri



ŽLEB POLKROŽNI [s=0, 60 mm]

TZ-TZZ



Nominalna velikost	Dolžina v m	EAN številko izdelka	Pakiranje v m		Cena [€/m]	
					Brez DDV	Z DDV
250 *	3,0	047953	15	720	7,25	8,85
250 *	4,0	047977	20	960	7,25	8,85
333 *	3,0	048110	15	495	9,50	11,59
333 *	4,0	048134	20	660	9,50	11,59
333 *	5,0	048158	25	825	9,50	11,59
333 *	6,0	048189	30	990	9,50	11,59

* Izdelava po meri



ŽLEB LEŽEČI

TZ-TZZS

Nominalna velikost	Dolžina v m	EAN številko izdelka	Pakiranje v m		Cena [€/m]	
					Brez DDV	Z DDV
650	4,0	000439	4	200	31,10	37,94

* Izdelava po meri

DILETACIJA ZA ŽLEB POLKROŽNI

TZ-TZZDI

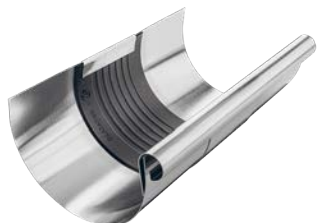

Nominalna velikost	EAN številko izdelka	Pakiranje v kos		Cena [€/kos]	
				Brez DDV	Z DDV
250/260	082688	3	360	13,50	16,47
280/260	082695	3	360	13,70	16,71
333/260	082701	5	200	13,70	16,71
400/260	082718	5	200	17,60	21,47



DILETACIJA ZA LEŽEČI ŽLEB

TZ-TZZSDI

Nominalna velikost	EAN številko izdelka	Pakiranje v kos		Cena [€/kos]	
				Brez DDV	Z DDV
670/260	082725	1	40	36,50	44,53



DILETACIJSKI TRAK

TZ-TZZDIP

Nominalna velikost	Dolžina v m	EAN številko izdelka	Pakiranje v m		Cena [€/m]	
					Brez DDV	Z DDV
260	3,0	028020	3	120	45,00	54,90
260	6,0	028037	6	240	45,00	54,90

UPORABA DILATACIJSKEGA ŽLEBA IN DILATACIJSKEGA TRAKU

DILATACIJSKI ŽLEB

Primer montaže: Razvite širine do 500 mm. Dilatacijski žleb mora biti nameščen z razmikom 15 m. Za zunanji vogal in začetek žleba velja polovica standardne vrednosti: največ 7,5 m. Za notranji vogal velja četrtina standardne vrednosti: največ 3,75 m. Za druge materiale in dimenzije: glej tabelo spodaj. Vogali vedno štejejo kot fiksne točke.

DILATACIJSKI TRAK

Notranja namestitev: na žlebove pritrjen brez lepljenja na podlago, strehe z nestandardnim profilom in pločevinsko obrobo zidov

STREŠNI POLOGLATI DILATACIJSKI ŽLEBOVI

Razvita širina žleba	Aluminij	Pocinkano, Cinkotit, Baker, Inox
< 500	12	15
> 500	8	10

STREŠNI DILATACIJSKI TRAK

Razvita širina žleba	Aluminij	Pocinkano, Cinkotit, Baker, Inox
< 500	8	10
> 500	6	8

Za zunanji vogal ali začetek žleba velja polovica standardne vrednosti. Za notranji vogal velja ena četrtina standardne vrednosti.

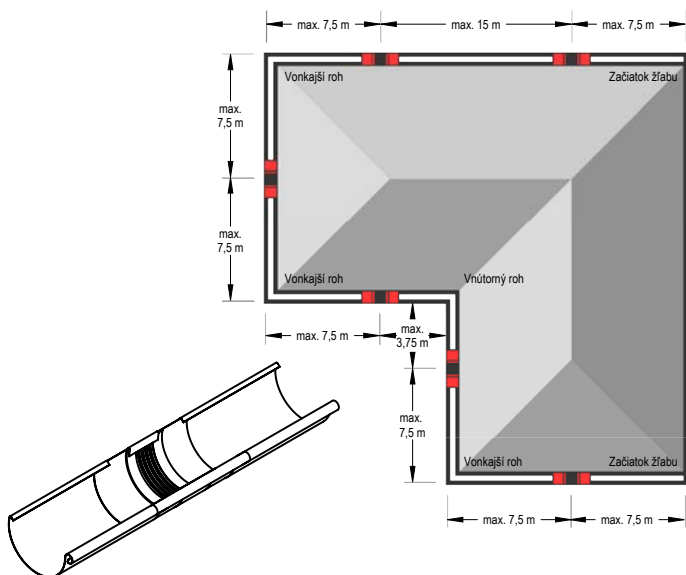

Opomba za montažo dilatacijskega žleba

Pri montaži s spajkanjem najprej srednji gumijasti del pokrijte z mokro krpo (da ne pride do prehoda toplotev srednji gumijasti del). Upoštevati je potrebno minimalno razdaljo 6 cm od srednjega gumijastega dela. V vsakem primeru se izogibajte kontaktu gume z odprtim ognjem.

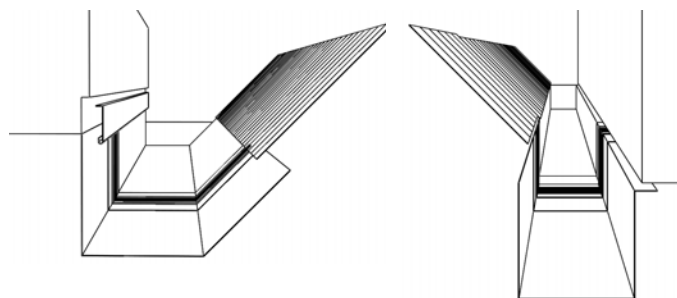

Opomba za montažo dilatacijskega traku

Pri krivljenju in montaži dilatacijskih elementov preverite, ali:

- je radij čeljusti za krivljenje vsaj 2 mm.
- Za debelino pločevine od 1 mm mora biti polmer krivljenja vsaj 5 mm.
- Čeljusti morajo biti za krivljenje nastavljene v debelini srednjega gumijastega dela 3 do 4 mm, da se prepreči učinek rezanja – poškodovanja gume.
- Gumijasti srednji del ne sme biti med krivljenjem stisnjen ali poškodovan. Zato je treba uporabiti aluminijški pločevinski trak 2 do 5 mm (debeline) ukrivljen tako, da se lahko pritrdi kot zaščita na čeljusti. Tako dosežete večji polmer krivljenja in preprečite poškodovanje gumijastega srednjega dela.



ALUMINIJ MREŽA ZA LOVLJENJE NESNAGE

W-WZNL M

Nominalna velikost	Dolžina v m	EAN številko izdelka	Pakiranje v kos		Cena [€/kos]	
					Brez DDV	Z DDV
333	2,0	064905	25	300	25,50	31,11

PVC MREŽA ZA LOVLJENJE LISTJA

SD-ZNL MREZKA

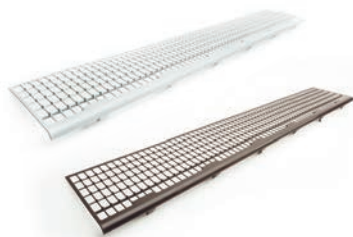

Nominalna velikost	Dolžina v m	EAN številko izdelka	Pakiranje v kos		Cena [€/kos]	
					Brez DDV	Z DDV
171	1,0	008473	30	450	4,50	5,49
171	1,0	008466	30	450	4,50	5,49

PVC MREŽA ZA LOVLJENJE LISTJA

SD-ZNL N

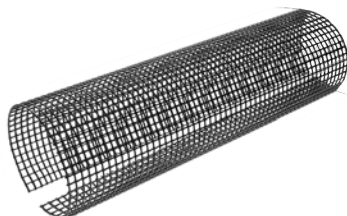

Nominalna velikost	Dolžina v m	EAN številko izdelka	Pakiranje v kos		Cena [€/kos]	
					Brez DDV	Z DDV
250	3,0	008480	10	400	23,90	29,16
280-333	3,0	008497	10	400	24,00	29,28





SPOJKA ŽLEBA

TZ-TZSPZ

Nominalna velikost	EAN številko izdelka	Pakiranje v kos		Cena [€/kos]	
				Brez DDV	Z DDV
250 *	102454	5	600	V PROCESU TESTIRANJA	
280 *	102461	5	600	V PROCESU TESTIRANJA	
333 *	102478	5	600	V PROCESU TESTIRANJA	

* Izdelava po meri



KLJUKA OBLEČNA

TZ-TZHOB

Nominalna velikost	Material	EAN številko izdelka	Pakiranje v kos		Cena [€/kos]	
					Brez DDV	Z DDV
200/380	25/6	032805	10	1 000	4,40	5,37
250/430	25/6	032812	10	1 000	3,50	4,27
280/480	25/6	032829	10	1 000	3,80	4,64
333/550	25/6	032836	10	1 000	4,00	4,88
333/610	25/6	032843	10	1 000	4,75	5,80
400/650	25/6	032850	10	500	6,35	7,75

CINKOTIT



KLJUKA ZA LEŽEČI ŽLEB OBLEČNA

TZ-TZHOBSSN

Nominalna velikost	Material	EAN številko izdelka	Pakiranje v kos		Cena [€/kos]	
					Brez DDV	Z DDV
4	25/6	000910	15	300	17,30	21,11

VOGALNIK NOTRANJI

TZ-TZRA



Nominalna velikost	EAN številko izdelka	Pakiranje v kos		Cena [€/kos]	
				Brez DDV	Z DDV
200	000811	5	150	15,00	18,30
250	000828	5	150	15,00	18,30
280	000835	5	150	16,60	20,25
333	000842	5	150	16,60	20,25
400	000859	5	150	32,90	40,14

VOGALNIK ZUNANJI

TZ-TZRI



Nominalna velikost	EAN številko izdelka	Pakiranje v kos		Cena [€/kos]	
				Brez DDV	Z DDV
200	000866	5	150	15,00	18,30
250	000873	5	150	15,00	18,30
280	000880	5	150	16,60	20,25
333	000897	5	150	16,60	20,25
400	000903	5	150	32,90	40,14

ZAKLJUČEK ŽLEBA

TZ-TZCL



Nominalna velikost	EAN številko izdelka	Pakiranje v kos		Cena [€/kos]	
				Brez DDV	Z DDV
200	001665	6/60	1 440	0,80	0,98
250	001672	50	4 500	0,70	0,85
280	001689	50	4 500	0,80	0,98
333	001696	50	4 500	0,95	1,16
400	001702	4/40	960	1,55	1,89

ZAKLJUČEK Z GUMO

TZ-TZCLG



Nominalna velikost	EAN številko izdelka	Pakiranje v kos		Cena [€/kos]	
				Brez DDV	Z DDV
250 *	004390	25	2 250	V PROCESU TESTIRANJA	
280 *	004406	25	2 250	V PROCESU TESTIRANJA	
333 *	004413	25	2 250	V PROCESU TESTIRANJA	

* Izdelava po meri

KOTLIČEK

TZ-TZKL



Nominalna velikost	EAN številko izdelka	Pakiranje v kos		Cena [€/kos]	
				Brez DDV	Z DDV
200/60	003775	20	600	8,70	10,61
250/60	003782	20	600	8,10	9,88
250/80	003799	20	600	6,50	7,93
280/80	003805	20	600	8,15	9,94
280/100	003812	20	600	7,50	9,15
333/80	003829	20	600	10,00	12,20
333/100	003836	20	600	8,20	10,00
333/120	003843	15	300	11,50	14,03
400/100	003850	15	300	16,00	19,52
400/120	003867	15	300	17,70	21,59
400/150	003874	15	300	21,00	25,62

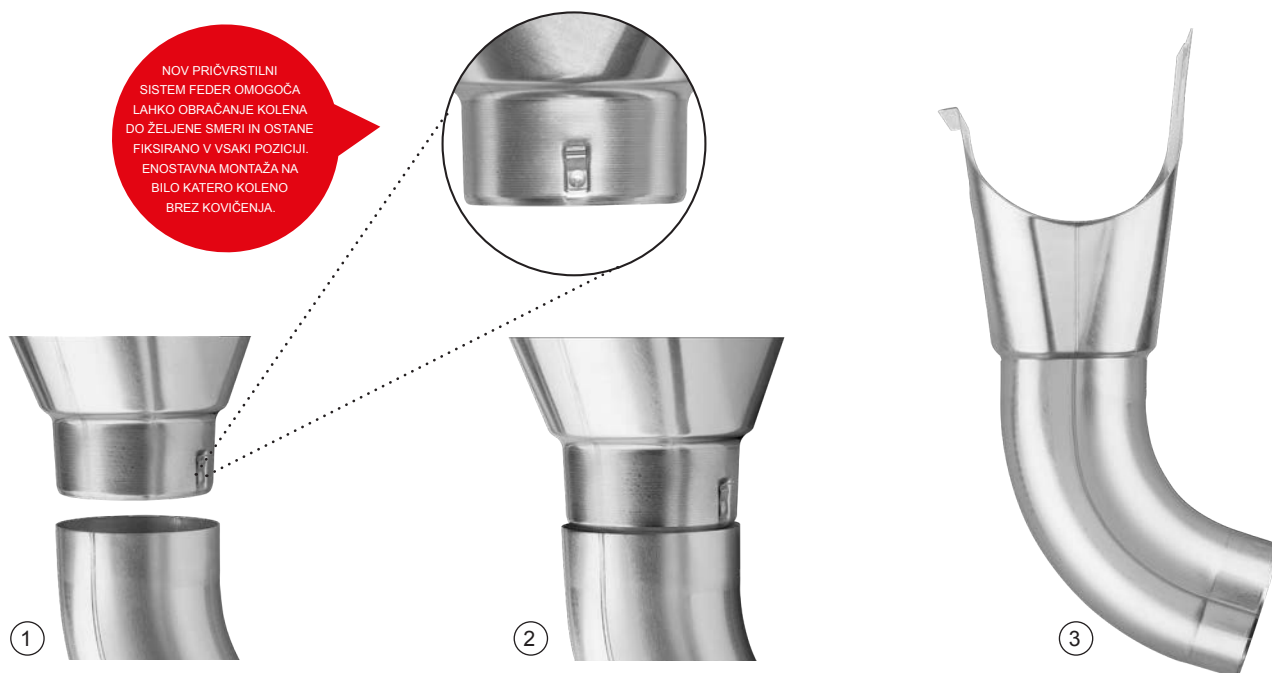

GRLO ZA STREŠNI ŽLEB

TZ-TZHRD



Nominalna velikost	EAN številko izdelka	Pakiranje v kos		Cena [€/kos]	
				Brez DDV	Z DDV
80	102539	40	1 000	2,30	2,81
100	102546	25	1 000	2,60	3,17
120	102553	15	750	3,50	4,27

INOX LOVILEC NESNAGE

N-NZN



Nominalna velikost	EAN številko izdelka	Pakiranje v kos		Cena [€/kos]	
				Brez DDV	Z DDV
60	001153	30	2 160	5,55	6,77
80	001160	20	1 440	5,60	6,83
100	001177	15	1 080	5,70	6,95
120	001184	10	720	6,20	7,56
150	001191	5	360	9,80	11,96



ZBIRNI KOTLIČEK DESIGN

TZ-TZKLZ DE



Nominalna velikost	EAN številko izdelka	Pakiranje v kos		Cena [€/kos]	
				Brez DDV	Z DDV
80	007834	2	36	65,00	79,30
100	007858	2	36	65,00	79,30
120	007872	2	36	66,00	80,52

ZBIRNI KOTLIČEK DESIGN EKSCENTRIČE

TZ-TZKLZ DX



Nominalna velikost	EAN številko izdelka	Pakiranje v kos		Cena [€/kos]	
				Brez DDV	Z DDV
80 *	007896	2	36	75,00	91,50
100	007926	2	36	75,00	91,50
120	007957	2	36	76,50	93,33

* Izdelava po meri

ZBIRNI KOTLIČEK KUBICKI

TZ-TZKLZ KU



Nominalna velikost	EAN številko izdelka	Pakiranje v kos		Cena [€/kos]	
				Brez DDV	Z DDV
80 *	007841	2	36	97,20	118,58
100	007865	2	36	97,20	118,58
120	007889	2	36	97,20	118,58

* Izdelava po meri

ZBIRNI KOTLIČEK KUBICKI EKSCENTRIČEN

TZ-TZKLZ KX



Nominalna velikost	EAN številko izdelka	Pakiranje v kos		Cena [€/kos]	
				Brez DDV	Z DDV
80	007902	2	36	98,00	119,56
100	007933	2	36	98,00	119,56
120	007964	2	36	100,00	122,00

ZBIRNI KOTLIČEK KUBICKI EKSCENTRIČEN ISPUSTOM

TZ-TZKLZ KXV



Nominalna velikost	EAN številko izdelka	Pakiranje v kos		Cena [€/kos]	
				Brez DDV	Z DDV
80	007919	2	36	137,00	167,14
100	007940	2	36	137,00	167,14
120	007971	2	36	138,00	168,36

TESNILNA GUMA ZBIRNEGA KOTLIČKA

P-PKLZ T



Nominalna velikost	EAN številko izdelka	Pakiranje v kos		Cena [€/kos]	
				Brez DDV	Z DDV
IC 70-85	077103	5	600	4,00	4,88
IC 100-110	077110	5	600	4,10	5,00
IC 110-125	077097	5	600	4,20	5,12
PS 70-85	077134	5	600	4,50	5,49
PS 100-110	077141	5	600	4,90	5,98
PS 110-125	077127	5	600	5,00	6,10

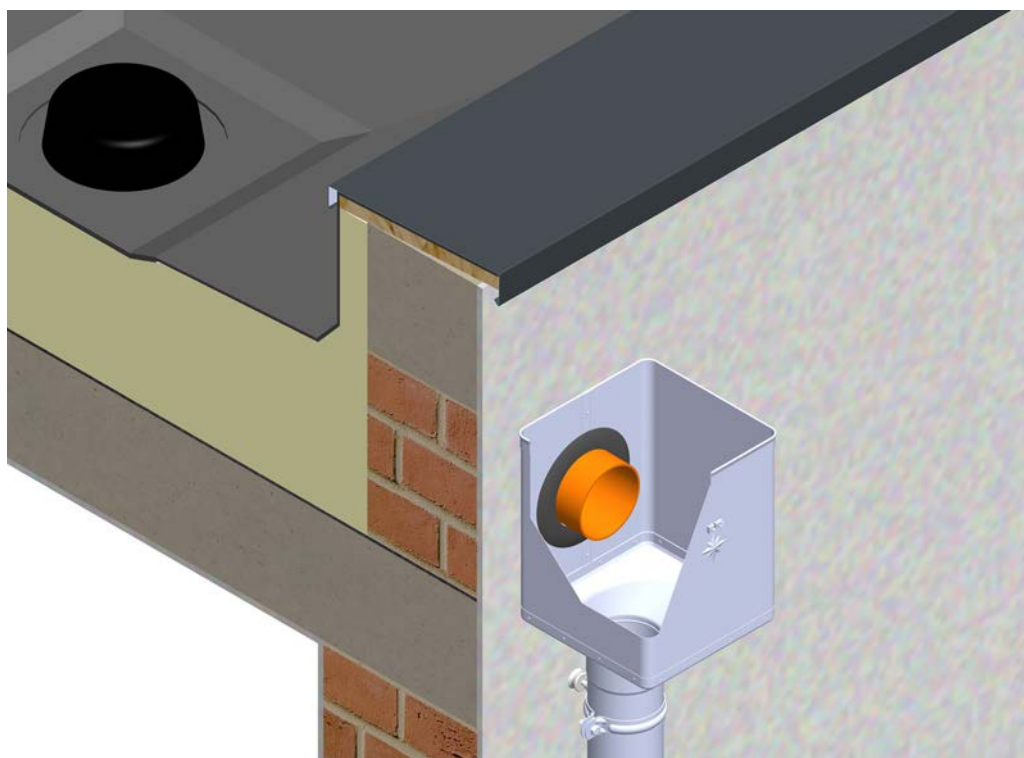

ODTOČNO KOLENO 72°

TZ-TZK



Nominalna velikost	EAN številko izdelka	Pakiranje v kos		Cena [€/kos]	
				Brez DDV	Z DDV
60	083081	25	600	6,10	7,44
80	083098	25	400	4,45	5,43
100	083111	25	300	5,20	6,34
120	083135	15	180	11,20	13,66
150	083159	5	90	39,00	47,58

ODTOČNO KOLENO 85°

TZ-TZKR



Nominalna velikost	EAN številko izdelka	Pakiranje v kos		Cena [€/kos]	
				Brez DDV	Z DDV
80	083104	25	400	7,80	9,52
100	083128	25	300	8,30	10,13
120	083142	15	180	18,30	22,33

ODTOČNO KOLENO 40°

TZ-TZKT



Nominalna velikost	EAN številko izdelka	Pakiranje v kos		Cena [€/kos]	
				Brez DDV	Z DDV
80	083166	25	400	5,40	6,59
100	083173	25	300	6,90	8,42
120	083180	15	240	13,50	16,47

CEV ODVODNA [s=0,65 mm]

TZ-TZZR





Nominalna velikost	Dolžina v m	EAN številko izdelka	Pakiranje v m		Cena [€/m]	
					Brez DDV	Z DDV
60	2,0	047618	2	490	6,90	8,42
60	3,0	047625	3	735	6,90	8,42
80	1,0	047649	10	100	7,60	9,27
80	2,0	047663	2	250	7,30	8,91
80	3,0	047687	3	375	7,30	8,91
80	4,0	047694	4	500	7,30	8,91
80 *	5,0	047700	5	625	7,30	8,91
80 *	6,0	047717	6	750	7,30	8,91
100	1,0	047731	10	70	9,20	11,22
100	2,0	047755	2	160	8,90	10,86
100	3,0	047779	3	240	8,90	10,86
100	4,0	047793	4	320	8,90	10,86
100 *	5,0	047816	5	400	8,90	10,86
100 *	6,0	047823	6	480	8,90	10,86
120	1,0	047830	8	48	11,75	14,34
120	2,0	047847	2	120	11,30	13,79
120	3,0	047854	3	180	11,30	13,79
120	4,0	047878	4	240	11,30	13,79
120 *	5,0	047892	5	300	11,30	13,79
120 *	6,0	047908	6	360	11,30	13,79

* Izdelava po meri



CEV ODVODNA [s=0,70 mm]

TZ-TZZR



Nominalna velikost	Dolžina v m	EAN številko izdelka	Pakiranje v m		Cena [€/m]	
					Brez DDV	Z DDV
150 ¹	4,0	047922	4	112	24,80	30,26

¹ Notranji zgib



CEV ODVODNA [s=0, 60 mm]

TZ-TZZR



Nominalna velikost	Dolžina v m	EAN številko izdelka	Pakiranje v m		Cena [€/m]	
					Brez DDV	Z DDV
80 *	1,0	047632	10	100	7,80	9,52
80 *	2,0	047656	2	250	7,80	9,52
80 *	3,0	047670	3	375	7,70	9,39
80 *	4,0	081742	4	500	7,70	9,39
80 *	5,0	081759	5	625	7,70	9,39
80 *	6,0	081766	6	750	7,70	9,39
100 *	1,0	047724	10	70	9,60	11,71
100 *	2,0	047748	2	160	9,60	11,71
100 *	3,0	047762	3	240	9,50	11,59
100 *	4,0	047786	4	320	9,50	11,59
100 *	5,0	047809	5	400	9,50	11,59
100 *	6,0	081773	6	480	9,50	11,59

* Izdelava po meri



PVC CEVNA FOLIJA

SD-ZR FOLIJA KJG

Rozmiar nominalny	Dolžina v m	EAN številko izdelka	Pakiranje v m		Cena [€/m]	
					Brez DDV	Z DDV
60-150	100,0	139726	100	6 000	0,38	0,46



ODTOČNO KOLENO ODSKOKOVÉ

TZ-TZKO

Nominalna velikost	EAN številko izdelka	Pakiranje v kos		Cena [€/kos]	
				Brez DDV	Z DDV
80	047380	20	320	9,20	11,22
100	047397	20	240	11,20	13,66
120	047403	15	180	21,00	25,62

REDUKCIJA CEVI 72°

TZ-TZZO

Nominalna velikost	EAN številko izdelka	Pakiranje v kos		Cena [€/kos]	
				Brez DDV	Z DDV
80/80	102560	4	90	16,80	20,50
100/60	102577	4	120	18,00	21,96
100/80	102584	4	120	18,00	21,96
100/100	102591	4	120	18,00	21,96
120/80	102607	3	90	22,40	27,33
120/100	102614	3	90	22,40	27,33
120/120	102621	3	90	22,40	27,33
150/120 *	102638	2	36	36,40	44,41
150/150 *	102645	2	36	39,50	48,19

* Izdelava po meri

OBJEMKA Z ŽEBLJEM 150 mm

TZ-TZO



Nominalna velikost	EAN številko izdelka	Pakiranje v kos		Cena [€/kos]	
				Brez DDV	Z DDV
80	008503	25	1 000	3,00	3,66
100	008510	25	1 000	3,30	4,03
120	008527	25	1 000	3,50	4,27

OBJEMKA Z ŽEBLJEM 200 mm

TZ-TZOD



Nominalna velikost	EAN številko izdelka	Pakiranje v kos		Cena [€/kos]	
				Brez DDV	Z DDV
80	008534	25	1 000	3,20	3,90
100	008541	25	1 000	3,45	4,21
120	008558	25	1 000	3,65	4,45

OBJEMKA Z ŽEBLJEM 300 mm

TZ-TZODD



Nominalna velikost	EAN številko izdelka	Pakiranje v kos		Cena [€/kos]	
				Brez DDV	Z DDV
100	008572	20	800	3,70	4,51
120	008589	20	800	4,10	5,00

OBJEMKA Z NAVOJEM M10

TZ-TZOB





Nominalna velikost	EAN številko izdelka	Pakiranje v kos		Cena [€/kos]	
				Brez DDV	Z DDV
60	000132	25	3 000	3,95	4,82
80	000149	25	3 000	3,00	3,66
100	000156	25	3 000	3,20	3,90
120	000163	25	3 000	3,70	4,51
150	000170	20	2 400	5,00	6,10



INOX VIJAK ZA OBJEMKO M6x20



P-POB-NSK

Nominalna velikost	EAN številko izdelka	Pakiranje v kos		Cena [€/kos]	
				Brez DDV	Z DDV
M6 x 20 *	071675	1	–	0,15	0,18

* Izdelava po meri

VIJAK ZA OBJEMKO TORX M10

P-POB-HT



Nominalna velikost	EAN številko izdelka	Pakiranje v kos		Cena [€/kos]	
				Brez DDV	Z DDV
80	002464	100	40 000	1,00	1,22
140	002471	100	28 000	1,25	1,53
200	002488	100	20 000	1,55	1,89
250	002495	100	16 000	1,70	2,07
300	002501	100	11 200	1,70	2,07



CINKOTIT

VLOŽEK M10



P-POB-HN DB

Nominalna velikost	EAN številko izdelka	Pakiranje v kos		Cena [€/kos]	
				Brez DDV	Z DDV
120	002426	100	25 000	0,40	0,49



VLOŽEK Z LAMELO M10



P-POB-HN DB

Nominalna velikost	EAN številko izdelka	Pakiranje v kos		Cena [€/kos]	
				Brez DDV	Z DDV
180	002433	100	12 000	0,42	0,51
240	002440	100	12 000	0,50	0,61
280	002457	100	12 000	0,53	0,65



KOMBINIRANI VIJAK TORX M10

P-POB-ZT/SZ

Nominalna velikost	EAN številko izdelka	Pakiranje v kos		Cena [€/kos]	
				Brez DDV	Z DDV
140	002587	50	10 400	0,45	0,55
180	002594	50	10 400	0,55	0,67



VLOŽEK ZA IZOLACIJO M10

P-POB-HN IZOL



Nominalna velikost	EAN številko izdelka	Pakiranje v kos		Cena [€/kos]	
				Brez DDV	Z DDV
M10 x 96	001207	25	2 625	2,70	3,29

IZOLACIJSKI ZATIČ KONICA ZIDAK BREZ TOPLLOTNE IZOLACIJE P-POB-HN WDVS140 M10



Nominalna velikost	EAN številko izdelka	Pakiranje v kos		Cena [€/kos]	
				Brez DDV	Z DDV
140	144843	1/5	750	4,80	5,86

IZOLACIJSKI ZATIČ KONICA ZIDAK S TOPLLOTNO IZOLACIJO P-POB-HN WDVS300 M10



Nominalna velikost	EAN številko izdelka	Pakiranje v kos		Cena [€/kos]	
				Brez DDV	Z DDV
300	144850	1/5	500	7,80	9,52

NERJAVNA UNI PLATFORMA ZA PRITRJEVANJE OB M10 P-POB-HN PLAT M10



Nominalna velikost	EAN številko izdelka	Pakiranje v kos		Cena [€/kos]	
				Brez DDV	Z DDV
M10	144836	25/500	5 000	3,35	4,09

NAVOJNA PALICA M10

P-POB-ZT



Nominalna velikost	EAN številko izdelka	Pakiranje v kos		Cena [€/kos]	
				Brez DDV	Z DDV
60	002556	100	20 800	0,20	0,24
100	002563	100	15 600	0,30	0,37
150	002570	50	10 400	0,55	0,67

PRITRDILNA PLOŠČA M10

P-POB-ZT MP



Nominalna velikost	EAN številko izdelka	Pakiranje v kos		Cena [€/kos]	
				Brez DDV	Z DDV
80 x 30	002518	25	5 200	1,15	1,40

ZAŠČITNI POKROV OBJEMKE

P-POB-HT AKG



Nominalna velikost	EAN številko izdelka	Pakiranje v kos		Cena [€/kos]	
				Brez DDV	Z DDV
29 x 13	002280	50	16 800	0,25	0,31
29 x 13	002211	50	16 800	0,25	0,31
29 x 13	002235	50	16 800	0,25	0,31
29 x 13	002266	50	16 800	0,25	0,31
29 x 13	002242	50	16 800	0,25	0,31
29 x 13	002228	50	16 800	0,25	0,31
29 x 13	002273	50	16 800	0,25	0,31
29 x 13	002259	50	16 800	0,25	0,31
29 x 13	002297	50	16 800	0,25	0,31

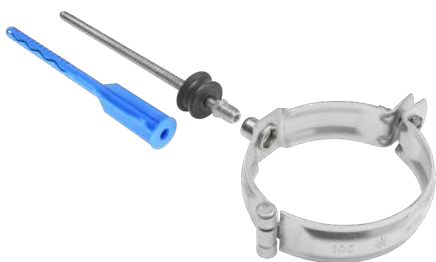

LOVILEC VODE

TZ-TZZV



Nominalna velikost	EAN številko izdelka	Pakiranje v kos		Cena [€/kos]	
				Brez DDV	Z DDV
80	035011	6	180	10,60	12,93
100	035028	5	150	13,00	15,86
120	035035	3	90	16,60	20,25

LOVILEC VODE S SITOM

TZ-TZZVS



Nominalna velikost	EAN številko izdelka	Pakiranje v kos		Cena [€/kos]	
				Brez DDV	Z DDV
80	034984	6	180	13,00	15,86
100	034991	5	150	14,90	18,18
120	035004	3	90	25,00	30,50

CINKOTIT

LOVILEC VODE S CEVJO

TZ-TZZVHA



Nominalna velikost	EAN številko izdelka	Pakiranje v kos		Cena [€/kos]	
				Brez DDV	Z DDV
80	001450	1	60	60,00	73,20
100	001467	1	60	63,00	76,86
120	001474	1	60	99,00	120,78

Dimenzija: 80, 120

Dimenzija: 100



POCINKANO ZAŠČITNA CEV Z REVIZIJSKO ODPRTINO P-POZR

Nominalna velikost	Dolžina v m	EAN številko izdelka	Pakiranje v kos		Cena [€/kos]	
					Brez DDV	Z DDV
80	1,0	009708	1	70	60,00	73,20
100	1,0	009715	1	60	45,00	54,90
100	1,5	009722	1	60	89,00	108,58



POCINKANO ZAŠČITNA CEV Z REVIZIJSKO ODPRTINO P-POZR

Nominalna velikost	Dolžina v m	EAN številko izdelka	Pakiranje v kos		Cena [€/kos]	
					Brez DDV	Z DDV
120	1,0	009739	1	40	105,00	128,10
120	1,5	009746	1	40	143,00	174,46

CINKOTIT



POCINKANO OBJEMKA Z GUMO M10 P-POB-OZR

Nominalna velikost	EAN številko izdelka	Pakiranje v kos		Cena [€/kos]	
				Brez DDV	Z DDV
80	002525	25	1 250	1,55	1,89
100	002532	25	1 250	2,00	2,44
120	002549	20	1 000	2,25	2,75

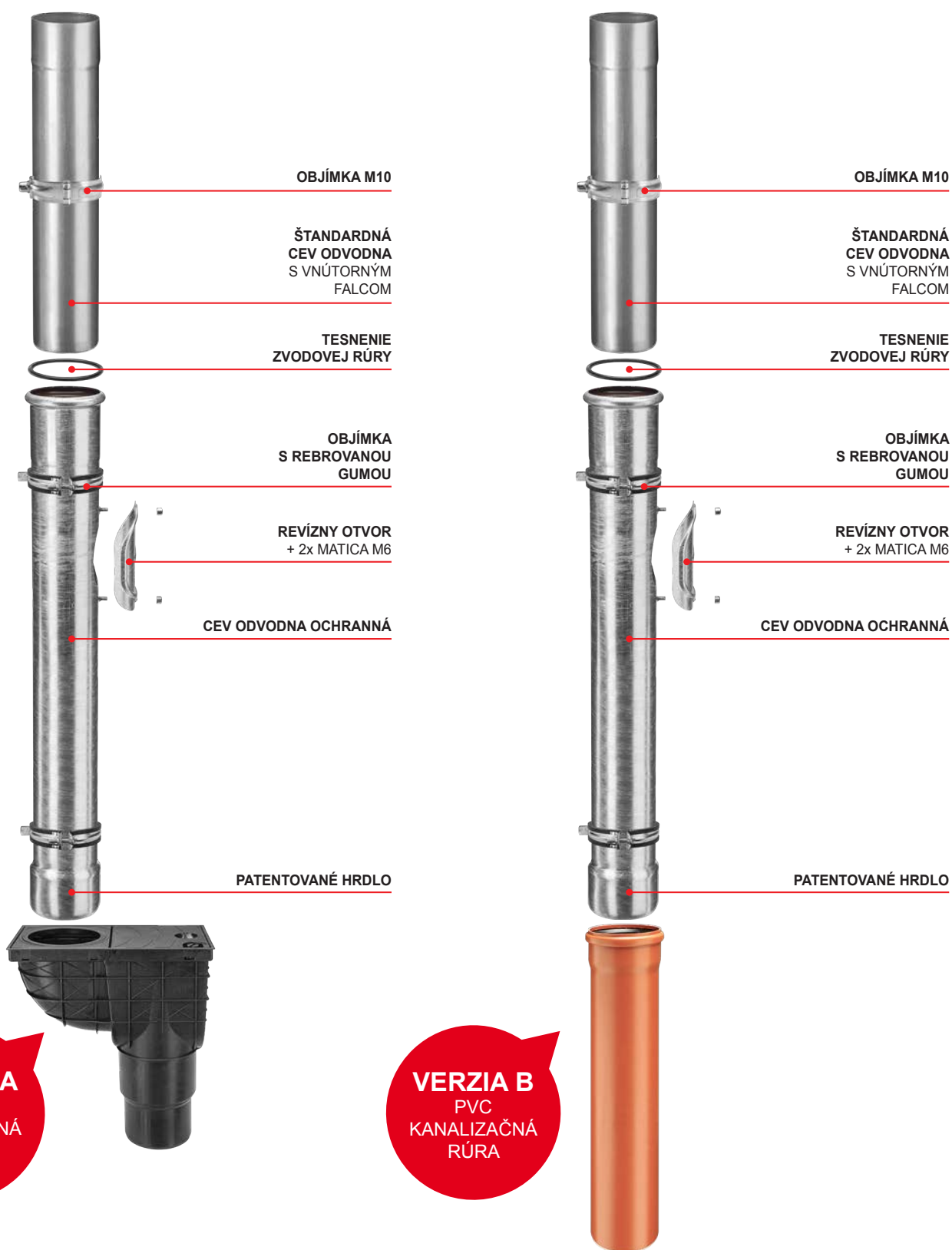

VERZIA A
PVC
KANALIZAČNÁ
VPUSŤ

VERZIA B
PVC
KANALIZAČNÁ
RÚRA

CINKOTIT

