



ODVODNI SISTEM POLUOKRUGLI



**CJENIK
2024**





Aluminijski materijal | 5



Žlijeb | 7

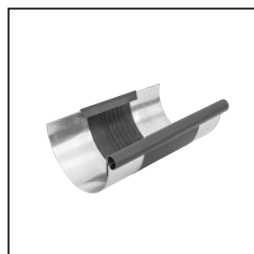

Dilekcija žlijeba | 9



Žlijeb oprema | 12



Kuka | 14



Kutnik | 17



Čelo žlijeba | 19



Kotlić | 20

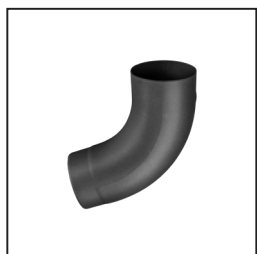

Koljeno | 30

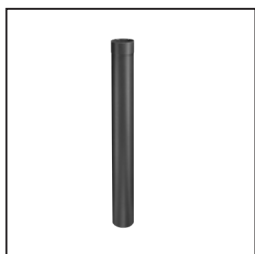

Odvodna cijev | 33



Odvodna cijev oprema | 35



Obujmica | 37

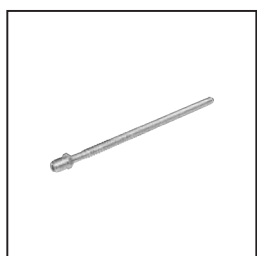

Obujmica oprema | 38



Zadržać vode | 41

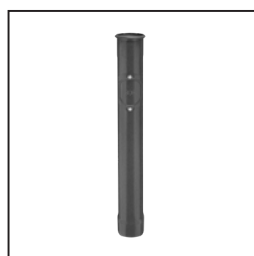

Zaštitna cijev | 43

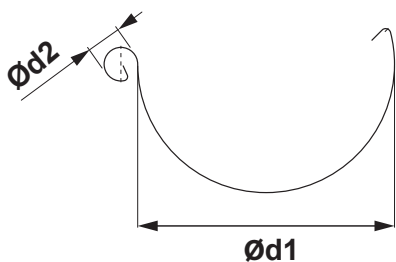

DIMENZIJE KROVNIH ŽLJEBOVA

(dimenzije i mjerne tolerancije po EN 612)

Razvijena širina (mm)	250	280	333
Ød1	105	127	153
Ød2	18	18	20

UNUTARNJI FALZ

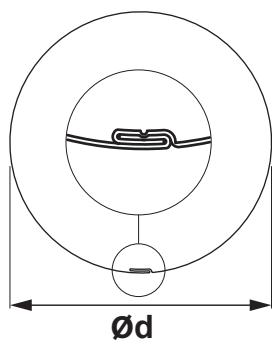

DIMENZIJE KROVNIH CIJEVI

(dimenzije i mjerne tolerancije po EN 612)

Dimenzije	80	100	120
Nazivna veličina Ød (mm)	80	100	120

DIMENZIJE KROVNIH KUKA

(dimenzije i mjerne tolerancije po EN 612)

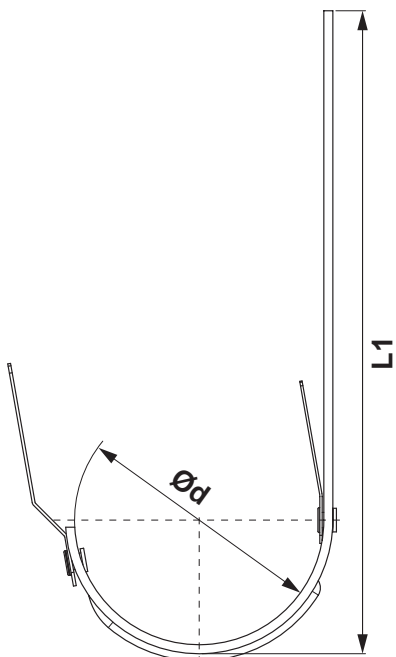

Dimenzije (mm)	L1	Ød
250	310	105
280	337	127
333 – 550	385	153

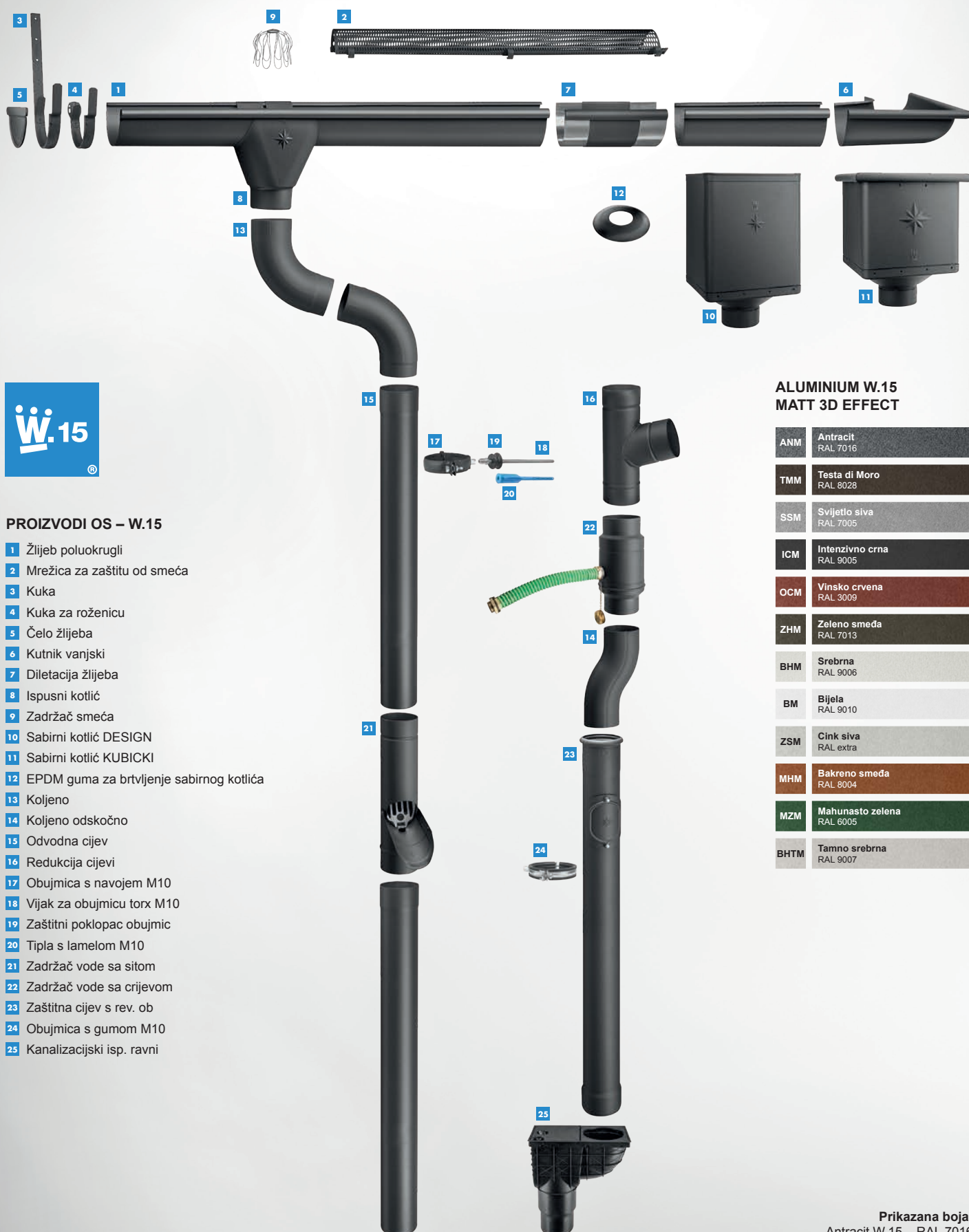

PROIZVODI OS – W.15

- 1 Žlijeb poluokrugli
- 2 Mrežica za zaštitu od smeća
- 3 Kuka
- 4 Kuka za roženicu
- 5 Čelo žlijeba
- 6 Kutnik vanjski
- 7 Diletacija žlijeba
- 8 Ispusni kotlić
- 9 Zadržlač smeća
- 10 Sabirni kotlić DESIGN
- 11 Sabirni kotlić KUBICKI
- 12 EPDM guma za brtvljenje sabirnog kotlića
- 13 Koljeno
- 14 Koljeno odskočno
- 15 Odvodna cijev
- 16 Redukcija cijevi
- 17 Obujmica s navojem M10
- 18 Vijak za obujmicu torx M10
- 19 Zaštitni poklopac obujmic
- 20 Tipla s lamelom M10
- 21 Zadržlač vode sa sitom
- 22 Zadržlač vode sa crijevom
- 23 Zaštitna cijev s rev. ob
- 24 Obujmica s gumom M10
- 25 Kanalizacijski isp. ravni

ALUMINIUM W.15 MATT 3D EFFECT

ANM	Antracit RAL 7016
TMM	Testa di Moro RAL 8028
SSM	Svijetlo siva RAL 7005
ICM	Intenzivno crna RAL 9005
OCM	Vinsko crvena RAL 3009
ZHM	Zeleno smeđa RAL 7013
BHM	Srebrna RAL 9006
BM	Bijela RAL 9010
ZSM	Cink siva RAL extra
MHM	Bakreno smeđa RAL 8004
MZM	Mahunasto zelena RAL 6005
BHTM	Tamno srebrna RAL 9007





ALUMINIUM W.15 MATT 3D EFFECT

SPEIRA

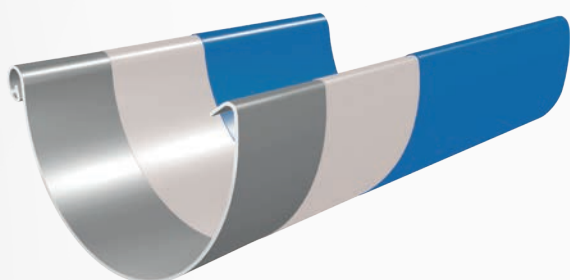
Speira je globalna tvrtka za valjanje i recikliranje aluminija. Ima sedam tvornica i jedan centar za istraživanje i razvoj, koji se nalaze u Njemačkoj i Norveškoj, uključujući i našu zajedničku tvrtku Alunorf, najveću valjaonu aluminija na svijetu, kao i nekoliko međunarodnih prodajnih kancelarija. Speira zapošljava oko 5 000 ljudi posebice u Njemačkoj i Norveškoj.



-  Gornji sloj je lak (cca. 20 μm) na poliuretanskoj bazi za odličan izgled, izvrsnu otpornost na ogrebotine i 3D MATT efekt
-  Primer (cca. 5 μm) za savršeno prijanjanje i snažnu zaštitu od korozije
-  Alumijski lim optimiziran za proizvodnju odvodnog sistema OS – W.15



ALUMINIJSKI PROIZVOD SA ATRAKTIVNOM MATNOM POVRŠINOM





W.15

- ✦ Kvalitetan premaz sa lotosovim efektom
- ✦ Visoka otpornost na ogrebotine
- ✦ Visoka koncentracija premaza
- ✦ W.15 – dvanaest nijansi boja
- ✦ 40 godina jamstva na materijal i boju

ŽLIJEB POLUOKRUGLI [s=0,70]

W.15-WZ

Nominalna veličina	250		280		333		333		
Dužina u m	4,0		4,0		4,0		6,0		
Cijena u €/m	Bez PDV	S PDV	Bez PDV	S PDV	Bez PDV	S PDV	Bez PDV	S PDV	
ANM Antracit RAL 7016	1	6,15	7,69	7,75	9,69	7,80	9,75	7,80	9,75
		094001		094018		094025		094032	
TMM Testa di Moro RAL 8028	2	6,15	7,69	7,75	9,69	7,80	9,75	7,80	9,75
		100030		100047 *		100054		100061	
SSM Svijetlo siva RAL 7005	3	6,15	7,69	7,75	9,69	7,80	9,75	7,80	9,75
		099990		100009		100016		100023	
ICM Intenzivno crna RAL 9005	4	6,15	7,69	7,75	9,69	7,80	9,75	7,80	9,75
		114662		114679		114686		114693	
OCM Vinsko crvena RAL 3009	5	6,15	7,69	7,75	9,69	7,80	9,75	7,80	9,75
		114709		114716 *		114723 *		114730	
ZHM Zeleno smeđa RAL 7013	6	6,15	7,69	7,75	9,69	7,80	9,75	7,80	9,75
		111982		111999		112002		112019	
BHM Srebrna RAL 9006	7	6,15	7,69	7,75	9,69	7,80	9,75	7,80	9,75
		114624		114631 *		114648		114655	
BM Bijela RAL 9010	8	6,15	7,69	7,75	9,69	7,80	9,75	7,80	9,75
		132833 *		132888 *		132932		132949	
ZSM Cink siva RAL extra	9	6,15	7,69	7,75	9,69	7,80	9,75	7,80	9,75
		132796 *		132840 *		132895 *		132987 *	
MHM Bakreno smeđa RAL 8004	10	6,15	7,69	7,75	9,69	7,80	9,75	7,80	9,75
		132819 *		132864 *		132918 *		132963 *	
MZM Mahunasto zelena RAL 6005	11	6,15	7,69	7,75	9,69	7,80	9,75	7,80	9,75
		132802 *		132857 *		132901 *		132970 *	
BHTM Tamno srebrna RAL 9007	12	6,15	7,69	7,75	9,69	7,80	9,75	7,80	9,75
		132826 *		132871 *		132925 *		132956 *	
Pak. u m 		20		20		20		30	
Pak. u m 		960		840		660		990	

* Proizvodnja po narudžbi





ALUMINIUM W.15

MATT 3D EFFECT

ŽLIJEB NATKROVNI [s=0,70]

W.15-WZS



Nominalna veličina	650	
Dužina u m	6,0	
Cijena u €/m	Bez PDV	S PDV
ANM 1 Antracit RAL 7016	20,10	25,13
	094179	
TMM 2 Testa di Moro RAL 8028	20,10	25,13
	100214 *	
SSM 3 Svijetlo siva RAL 7005	20,10	25,13
	100221 *	
ICM 4 Intenzivno crna RAL 9005	20,10	25,13
	114471 *	
OCM 5 Vinsko crvena RAL 3009	20,10	25,13
	114488 *	
ZHM 6 Zeleno smeđa RAL 7013	20,10	25,13
	112125 *	
BHM 7 Srebrna RAL 9006	20,10	25,13
	114495 *	
BM 8 Bijela RAL 9010	20,10	25,13
	137500 *	
ZSM 9 Cink siva RAL extra	20,10	25,13
	137531 *	
MHM 10 Bakreno smeđa RAL 8004	20,10	25,13
	137517 *	
MZM 11 Mahunasto zelena RAL 6005	20,10	25,13
	137524 *	
BHTM 12 Tamno srebrna RAL 9007	20,10	25,13
	137494 *	
Pak. u m 	6	
Pak. u m 	300	

* Proizvodnja po narudžbi



STREŠNÝ DILATAČNÝ ŽLAB POLKRUHOVÝ

W.15-WZDI

Nominalna veličina	250/260		285/260		333/260	
	Bez PDV	S PDV	Bez PDV	S PDV	Bez PDV	S PDV
ANM 1 Antracit RAL 7016	21,30	26,63	22,35	27,94	22,35	27,94
	093356 *		093363 *		093370	
TMM 2 Testa di Moro RAL 8028	21,30	26,63	22,35	27,94	22,35	27,94
	098702 *		098719 *		098726	
SSM 3 Svijetlo siva RAL 7005	21,30	26,63	22,35	27,94	22,35	27,94
	098818 *		098825 *		098832 *	
ICM 4 Intenzivno crna RAL 9005	21,30	26,63	22,35	27,94	22,35	27,94
	118738 *		118745 *		118752	
OCM 5 Vinsko crvena RAL 3009	21,30	26,63	22,35	27,94	22,35	27,94
	118769 *		118776 *		118783 *	
ZHM 6 Zeleno smeđa RAL 7013	21,30	26,63	22,35	27,94	22,35	27,94
	111401 *		111418 *		111432	
BHM 7 Srebrna RAL 9006	21,30	26,63	22,35	27,94	22,35	27,94
	118707 *		118714 *		118721 *	
BM 8 Bijela RAL 9010	21,30	26,63	22,35	27,94	22,35	27,94
	137029 *		137036 *		137043 *	
ZSM 9 Cink siva RAL extra	21,30	26,63	22,35	27,94	22,35	27,94
	137111 *		137128 *		137135 *	
MHM 10 Bakreno smeđa RAL 8004	21,30	26,63	22,35	27,94	22,35	27,94
	137050 *		137067 *		137074 *	
MZM 11 Mahunasto zelena RAL 6005	21,30	26,63	22,35	27,94	22,35	27,94
	137081 *		137098 *		137104 *	
BHTM 12 Tamno srebrna RAL 9007	21,30	26,63	22,35	27,94	22,35	27,94
	136992 *		137005 *		137012 *	
Pak. u kom 	3		3		5	
Pak. u kom 	360		360		200	

* Proizvodnja po narudžbi

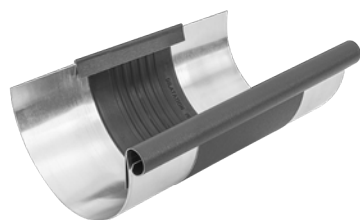



ALUMINIUM W.15

MATT 3D EFFECT

DILETACIJA ZA LEŽEĆI ŽLIJEB

W.15-WZSDI

Nominalna veličina	670/260	
Cijena u €/kom	Bez PDV	S PDV
ANM 1 Antracit RAL 7016	67,60	84,50
	093400 *	
TMM 2 Testa di Moro RAL 8028	67,60	84,50
	098757 *	
SSM 3 Svijetlo siva RAL 7005	67,60	84,50
	098863 *	
ICM 4 Intenzivno crna RAL 9005	67,60	84,50
	118806 *	
OCM 5 Vinsko crvena RAL 3009	67,60	84,50
	118813 *	
ZHM 6 Zelena smeđa RAL 7013	67,60	84,50
	111425 *	
BHM 7 Srebrna RAL 9006	67,60	84,50
	118790 *	
BM 8 Bijela RAL 9010	67,60	84,50
	137555 *	
ZSM 9 Cink siva RAL extra	67,60	84,50
	137586 *	
MHM 10 Bakreno smeđa RAL 8004	67,60	84,50
	137562 *	
MZM 11 Mahunasto zelena RAL 6005	67,60	84,50
	137579 *	
BHTM 12 Tamno srebrna RAL 9007	67,60	84,50
	137548 *	
Pak. u kom 		1
Pak. u kom 		40

* Proizvodnja po narudžbi



ALUMINIUM
W.15

KORIŠTENJE SPOJKE ŽLIJEBA I SPOJNE TRAKE

SPOJKA ŽLIJEBA

Primjer montaže: Podkrovni žlijeb razvijene širine do 500 mm. Spojka žlijeba mora biti montirana u međusobnoj udaljenosti 15 m. Za vanjski kutnik i početak žlijeba važi polovica standardne vrijednosti: maksimalno 7,5 m. Za unutarnji kutnik važi četvrtina standardne vrijednosti: maksimalno 3,75 m. Za ostale materijale i dimenzije: vidi tabelica dolje. Kutnici se uvijek smatraju čvrstim točkama.

KROVNI POLUOKRUGLI ŽLJEBOVI

Razvijena širina žlijeba	Aluminij	Pocink, Cinkotit, Bakar, Inox
< 500	12	15
> 500	8	10

SPAJANJE TRAKOM

Unutarnja instalacija: za četvrtaste žljebove pričvršćene za podlogu bez lijepljenja, za krovove s nestandardnim profilom, i oplatu zida limom

KROVNO SPAJANJE TRAKOM

Razvijena širina žlijeba	Aluminij	Pocink, Cinkotit, Bakar, Inox
< 500	8	10
> 500	6	8

Za vanjski kutnik ili početak žlijeba važi polovica standardne vrijednosti. Za unutarnji kutnik važi četvrtina standardne vrijednosti.

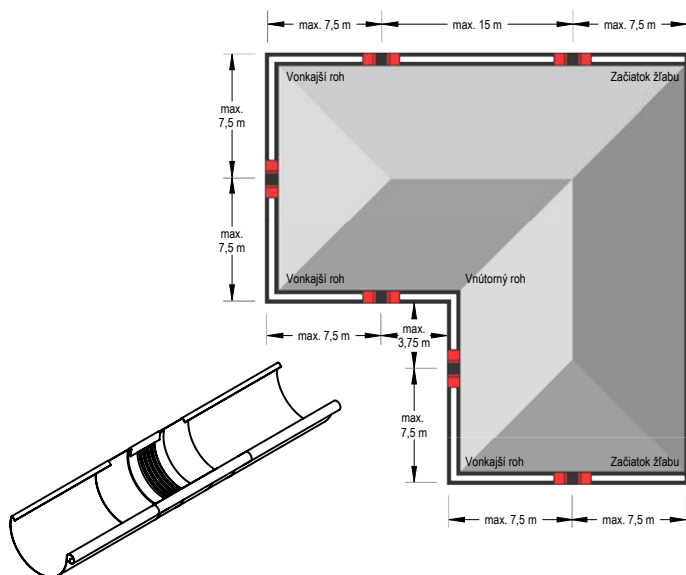

Napomena uz montažu spojne trake.

Za vrijeme montaže uz pomoć mekog lemljenja prvo pokrite dio mokrom krpom (kako ne bi došlo do prelaska topline u središnji gumeni dio). Mora se održavati minimalna udaljenost 6 cm od središnjeg gumenog dijela. U svakom slučaju treba izbjegavati kontakt gume s plamenom.

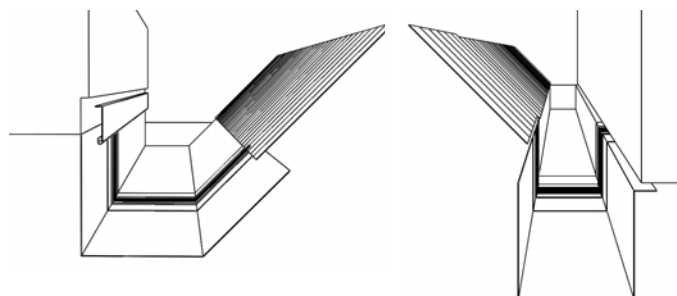

Napomena uz montažu spojne trake.

Kada se savija i montira spojna traka, provjerite sljedeće:



- Klješta za savijanje imaju radijus minimalno 2 mm.
- Za debljinu lima 1 mm se mora održati polumjer savijanja minimalno 5 mm.
- Klješta za savijanje moraju za vrijeme savijanja biti podešena za debljinu 3 do 4 mm, kako bi se spriječio efekt sječenja – oštećenja gume.
- Središnji gumeni dio za vrijeme savijanja ne smije biti pritisnut ili oštećen. Treba zbog toga koristiti aluminijsku limenu traku debljine 2 do 5 mm, i saviti je tako, da se može pričvrstiti kao zaštita za klješta za savijanje. Time ćemo dobiti veći polumjer savijanja, i spriječiti da se ošteti središnji gumeni dio.

ALUMINIUM W.15

MATT 3D EFFECT

MRIEŽKA ZACHYTÁVAČA NEČISTÔT

W.15-WZNLNLM

Nominalna veličina	333	
Dužina u m	2,0	
Cijena u €/kom	Bez PDV	S PDV
ANM 1 Antracit RAL 7016	27,00	33,75
	097149 *	
TMM 2 Testa di Moro RAL 8028	27,00	33,75
	118035 *	
SSM 3 Svijetlo siva RAL 7005	27,00	33,75
	118028 *	
ICM 4 Intenzivno crna RAL 9005	27,00	33,75
	118004 *	
OCM 5 Vinsko crvena RAL 3009	27,00	33,75
	118011 *	
ZHM 6 Zeleno smeđa RAL 7013	27,00	33,75
	118042 *	
BHM 7 Srebrna RAL 9006	27,00	33,75
	117991 *	
BM 8 Bijela RAL 9010	27,00	33,75
	137142 *	
ZSM 9 Cink siva RAL extra	27,00	33,75
	137173 *	
MHM 10 Bakreno smeđa RAL 8004	27,00	33,75
	137159 *	
MZM 11 Mahunasto zelena RAL 6005	27,00	33,75
	137166 *	
BHTM 12 Tamno srebrna RAL 9007	27,00	33,75
	137180 *	
Pak. u kom 	15	
Pak. u kom 	120	

* Proizvodnja po narudžbi

ALUMINIUM
W.15

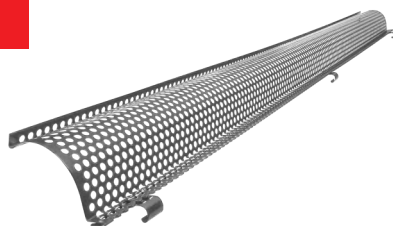



ALUMINIUM W.15

MATT 3D EFFECT



PVC ŽLIJEJNI ZADRŽAČ SMEĆA

SD-ZNL MRIEZKA

Nominalna veličina	Dužina u m	EAN broj narudžbe	Pakiranje u kom		Cijena [€/kom]	
					Bez PDV	S PDV
PS 171	1,0	008473	30	450	4,50	5,63
TM 171	1,0	008466	30	450	4,50	5,63

PVC ŽLIJEJNI ZADRŽAČ SMEĆA

SD-ZNL N

Nominalna veličina	Dužina u m	EAN broj narudžbe	Pakiranje u kom		Cijena [€/kom]	
					Bez PDV	S PDV
250	3,0	008480	10	400	23,90	29,88
280-333	3,0	008497	10	400	24,00	30,00





ALUMINIUM W.15

MATT 3D EFFECT

STREŠNÝ KUKA S PRELISOM

W.15-WHP

Nominalna veličina	250/430		280/480		333/550		
Materijal	23/7		28/7		28/7		
Cijena u €/kom	Bez PDV	S PDV	Bez PDV	S PDV	Bez PDV	S PDV	
ANM Antracit RAL 7016	1	3,55	4,44	4,05	5,06	4,45	5,56
		093455		093462		093479	
TMM Testa di Moro RAL 8028	2	3,55	4,44	4,05	5,06	4,45	5,56
		098986		098993		099006	
SSM Svijetlo siva RAL 7005	3	3,55	4,44	4,05	5,06	4,45	5,56
		098955		098962		098979	
ICM Intenzivno crna RAL 9005	4	3,55	4,44	4,05	5,06	4,45	5,56
		116475		116482		116499	
OCM Vinsko crvena RAL 3009	5	3,55	4,44	4,05	5,06	4,45	5,56
		116505		116512 *		116529	
ZHM Zeleno smeđa RAL 7013	6	3,55	4,44	4,05	5,06	4,45	5,56
		111449		111456		111463	
BHM Srebrna RAL 9006	7	3,55	4,44	4,05	5,06	4,45	5,56
		116444 *		116451 *		116468	
BM Bijela RAL 9010	8	3,55	4,44	4,05	5,06	4,45	5,56
		133083 *		133090 *		133106	
ZSM Cink siva RAL extra	9	3,55	4,44	4,05	5,06	4,45	5,56
		133175 *		133182 *		133199 *	
MHM Bakreno smeđa RAL 8004	10	3,55	4,44	4,05	5,06	4,45	5,56
		133113		133120 *		133137	
MZM Mahunasto zelena RAL 6005	11	3,55	4,44	4,05	5,06	4,45	5,56
		133144 *		133151 *		133168 *	
BHTM Tamno srebrna RAL 9007	12	3,55	4,44	4,05	5,06	4,45	5,56
		133052 *		133069 *		133076 *	
Pak. u kom 		15		15		15	
Pak. u kom 		600		600		600	



* Proizvodnja po narudžbi



STREŠNÝ KUKA KROKVA

W.15-WHPK



Nominalna veličina	250		280		333	
Materijal	28/7		28/7		28/7	
Cijena u €/kom	Bez PDV	S PDV	Bez PDV	S PDV	Bez PDV	S PDV
ANM Antracit RAL 7016	4,00	5,00	4,05	5,06	4,10	5,13
	093486		093493		093509	
TMM Testa di Moro RAL 8028	4,00	5,00	4,05	5,06	4,10	5,13
	099020 *		099044 *		099068	
SSM Svijetlo siva RAL 7005	4,00	5,00	4,05	5,06	4,10	5,13
	099013 *		099037 *		099051	
ICM Intenzivno crna RAL 9005	4,00	5,00	4,05	5,06	4,10	5,13
	118448 *		118455 *		118462 *	
OCM Vinsko crvena RAL 3009	4,00	5,00	4,05	5,06	4,10	5,13
	118479 *		118486 *		118493 *	
ZHM Zeleno smeđa RAL 7013	4,00	5,00	4,05	5,06	4,10	5,13
	111470 *		111487 *		111494	
BHM Srebrna RAL 9006	4,00	5,00	4,05	5,06	4,10	5,13
	118417 *		118424 *		118431 *	
BM Bijela RAL 9010	4,00	5,00	4,05	5,06	4,10	5,13
	133250 *		133267 *		133274 *	
ZSM Cink siva RAL extra	4,00	5,00	4,05	5,06	4,10	5,13
	133342 *		133359 *		133366 *	
MHM Bakreno smeđa RAL 8004	4,00	5,00	4,05	5,06	4,10	5,13
	133281 *		133298 *		133304 *	
MZM Mahunasto zelena RAL 6005	4,00	5,00	4,05	5,06	4,10	5,13
	133311 *		133328 *		133335 *	
BHTM Tamno srebrna RAL 9007	4,00	5,00	4,05	5,06	4,10	5,13
	133229 *		133236 *		133243 *	
Pak. u kom 	15		15		15	
Pak. u kom 	600		600		600	



* Proizvodnja po narudžbi

ALUMINIUM W.15

MATT 3D EFFECT

KUKA ZA NATKROVNI ŽLIJEBSPEVNENÝ

W.15-WHSG

Nominalna veličina	4	
Materijal	28/7	
Cijena u €/kom	Bez PDV	S PDV
ANM 1 Antracit RAL 7016	9,30	11,63
		093516
TMM 2 Testa di Moro RAL 8028	9,30	11,63
		099082 *
SSM 3 Svijetlo siva RAL 7005	9,30	11,63
		099075 *
ICM 4 Intenzivno crna RAL 9005	9,30	11,63
		114600 *
OCM 5 Vinsko crvena RAL 3009	9,30	11,63
		114617 *
ZHM 6 Zeleno smeđa RAL 7013	9,30	11,63
		111500 *
BHM 7 Srebrna RAL 9006	9,30	11,63
		114594 *
BM 8 Bijela RAL 9010	9,30	11,63
		135605 *
ZSM 9 Cink siva RAL extra	9,30	11,63
		135636 *
MHM 10 Bakreno smeđa RAL 8004	9,30	11,63
		135612 *
MZM 11 Mahunasto zelena RAL 6005	9,30	11,63
		135629 *
BHTM 12 Tamno srebrna RAL 9007	9,30	11,63
		135599 *
Pak. u kom 	10	
Pak. u kom 	400	

* Proizvodnja po narudžbi

ALUMINIUM
W.15



KUTNIK VANJSKI

W.15-WRA

Nominalna veličina	250		280		333	
	Bez PDV	S PDV	Bez PDV	S PDV	Bez PDV	S PDV
ANM 1 Antracit RAL 7016	15,40	19,25	16,10	20,13	16,85	21,06
	093905		093912		093929	
TMM 2 Testa di Moro RAL 8028	15,40	19,25	16,10	20,13	16,85	21,06
	099822		099839 *		099846	
SSM 3 Svijetlo siva RAL 7005	15,40	19,25	16,10	20,13	16,85	21,06
	099792		099808		099815	
ICM 4 Intenzivno crna RAL 9005	15,40	19,25	16,10	20,13	16,85	21,06
	118868		118875		118882	
OCM 5 Vinsko crvena RAL 3009	15,40	19,25	16,10	20,13	16,85	21,06
	118899 *		118905 *		118912 *	
ZHM 6 Zeleno smeđa RAL 7013	15,40	19,25	16,10	20,13	16,85	21,06
	111876		111883 *		111890	
BHM 7 Srebrna RAL 9006	15,40	19,25	16,10	20,13	16,85	21,06
	118837 *		118844 *		118851 *	
BM 8 Bijela RAL 9010	15,40	19,25	16,10	20,13	16,85	21,06
	136725 *		136732 *		136749	
ZSM 9 Cink siva RAL extra	15,40	19,25	16,10	20,13	16,85	21,06
	136817 *		136824 *		136831 *	
MHM 10 Bakreno smeđa RAL 8004	15,40	19,25	16,10	20,13	16,85	21,06
	136756		136763 *		136770	
MZM 11 Mahunasto zelena RAL 6005	15,40	19,25	16,10	20,13	16,85	21,06
	136787 *		136794 *		136800 *	
BHTM 12 Tamno srebrna RAL 9007	15,40	19,25	16,10	20,13	16,85	21,06
	136695 *		136701 *		136718 *	
Pak. u kom 	5		5		5	
Pak. u kom 	150		150		150	

* Proizvodnja po narudžbi

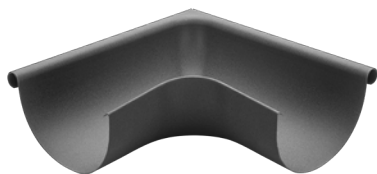

KUTNIK UNUTARNJI

W.15-WRI

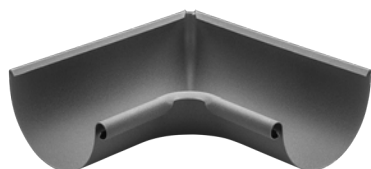

Nominalna veličina	250		280		333	
	Bez PDV	S PDV	Bez PDV	S PDV	Bez PDV	S PDV
ANM 1 Antracit RAL 7016	15,40	19,25	16,10	20,13	16,85	21,06
	093950		093967		093974	
TMM 2 Testa di Moro RAL 8028	15,40	19,25	16,10	20,13	16,85	21,06
	099884 *		099891 *		099907	
SSM 3 Svijetlo siva RAL 7005	15,40	19,25	16,10	20,13	16,85	21,06
	099853		099860		099877	
ICM 4 Intenzivno crna RAL 9005	15,40	19,25	16,10	20,13	16,85	21,06
	118950 *		118967 *		118974	
OCM 5 Vinsko crvena RAL 3009	15,40	19,25	16,10	20,13	16,85	21,06
	118981 *		118998 *		119001 *	
ZHM 6 Zeleno smeđa RAL 7013	15,40	19,25	16,10	20,13	16,85	21,06
	111906 *		111913 *		111920	
BHM 7 Srebrna RAL 9006	15,40	19,25	16,10	20,13	16,85	21,06
	118929 *		118936 *		118943 *	
BM 8 Bijela RAL 9010	15,40	19,25	16,10	20,13	16,85	21,06
	136879 *		136886 *		136893	
ZSM 9 Cink siva RAL extra	15,40	19,25	16,10	20,13	16,85	21,06
	136961 *		136978 *		136985 *	
MHM 10 Bakreno smeđa RAL 8004	15,40	19,25	16,10	20,13	16,85	21,06
	136909 *		136916 *		136923	
MZM 11 Mahunasto zelena RAL 6005	15,40	19,25	16,10	20,13	16,85	21,06
	136930 *		136947 *		136954 *	
BHTM 12 Tamno srebrna RAL 9007	15,40	19,25	16,10	20,13	16,85	21,06
	136848 *		136855 *		136862 *	
Pak. u kom 	5		5		5	
Pak. u kom 	150		150		150	

* Proizvodnja po narudžbi



ČELO ŽLIJEBA

W.15-WCL

Nominalna veličina	250		280		333	
	Bez PDV	S PDV	Bez PDV	S PDV	Bez PDV	S PDV
ANM 1 Antracit RAL 7016	1,55	1,94	1,60	2,00	1,65	2,06
	093301		093318		093325	
TMM 2 Testa di Moro RAL 8028	1,55	1,94	1,60	2,00	1,65	2,06
	098658 *		098665 *		098672	
SSM 3 Svijetlo siva RAL 7005	1,55	1,94	1,60	2,00	1,65	2,06
	098764		098771		098788	
ICM 4 Intenzivno crna RAL 9005	1,55	1,94	1,60	2,00	1,65	2,06
	118356		118363		118370	
OCM 5 Vinsko crvena RAL 3009	1,55	1,94	1,60	2,00	1,65	2,06
	118387 *		118394 *		118400	
ZHM 6 Zelena smeđa RAL 7013	1,55	1,94	1,60	2,00	1,65	2,06
	111371 *		111388 *		111395	
BHM 7 Srebrna RAL 9006	1,55	1,94	1,60	2,00	1,65	2,06
	118325 *		118332 *		118349	
BM 8 Bijela RAL 9010	1,55	1,94	1,60	2,00	1,65	2,06
	135476 *		135483 *		135490	
ZSM 9 Cink siva RAL extra	1,55	1,94	1,60	2,00	1,65	2,06
	135568 *		135575 *		135582 *	
MHM 10 Bakreno smeđa RAL 8004	1,55	1,94	1,60	2,00	1,65	2,06
	135506		135513 *		135520	
MZM 11 Mahunasto zelena RAL 6005	1,55	1,94	1,60	2,00	1,65	2,06
	135537 *		135544 *		135551 *	
BHTM 12 Tamno srebrna RAL 9007	1,55	1,94	1,60	2,00	1,65	2,06
	135445 *		135452 *		135469 *	
Pak. u kom 	6/60		6/60		6/60	
Pak. u kom 	1 440		1 440		1 440	

* Proizvodnja po narudžbi





ALUMINIUM W.15

MATT 3D EFFECT

ŽLABOVÝ KOTLÍK

W.15-WKL

Nominalna veličina	250/80		280/80		280/100	
	Bez PDV	S PDV	Bez PDV	S PDV	Bez PDV	S PDV
ANM 1 Antracit RAL 7016	11,75	14,69	13,50	16,88	13,00	16,25
	093585		093592 *		093608	
TMM 2 Testa di Moro RAL 8028	11,75	14,69	13,50	16,88	13,00	16,25
	099273		099280 *		099297	
SSM 3 Svijetlo siva RAL 7005	11,75	14,69	13,50	16,88	13,00	16,25
	099211		099228 *		099235	
ICM 4 Intenzivno crna RAL 9005	11,75	14,69	13,50	16,88	13,00	16,25
	116864		116871 *		116888	
OCM 5 Vinsko crvena RAL 3009	11,75	14,69	13,50	16,88	13,00	16,25
	116925 *		116932 *		116949 *	
ZHM 6 Zeleno smeđa RAL 7013	11,75	14,69	13,50	16,88	13,00	16,25
	111579		111586 *		111593	
BHM 7 Srebrna RAL 9006	11,75	14,69	13,50	16,88	13,00	16,25
	116802 *		116819 *		116826 *	
BM 8 Bijela RAL 9010	11,75	14,69	13,50	16,88	13,00	16,25
	135858 *		135865 *		135872 *	
ZSM 9 Cink siva RAL extra	11,75	14,69	13,50	16,88	13,00	16,25
	136039 *		136046 *		136053 *	
MHM 10 Bakreno smeđa RAL 8004	11,75	14,69	13,50	16,88	13,00	16,25
	135919		135926 *		135933 *	
MZM 11 Mahunasto zelena RAL 6005	11,75	14,69	13,50	16,88	13,00	16,25
	135971 *		135988 *		135995 *	
BHTM 12 Tamno srebrna RAL 9007	11,75	14,69	13,50	16,88	13,00	16,25
	135797 *		135803 *		135810 *	
Pak. u kom 	15		15		15	
Pak. u kom 	300		450		450	

* Proizvodnja po narudžbi



ŽLABOVÝ KOTLÍK

W.15-WKL

Nominalna veličina	333/80		333/100		333/120	
	Bez PDV	S PDV	Bez PDV	S PDV	Bez PDV	S PDV
ANM 1 Antracit RAL 7016	13,95	17,44	14,25	17,81	18,70	23,38
	093615 *		093622		093639	
TMM 2 Testa di Moro RAL 8028	13,95	17,44	14,25	17,81	18,70	23,38
	099303 *		099310		099327	
SSM 3 Svijetlo siva RAL 7005	13,95	17,44	14,25	17,81	18,70	23,38
	099242 *		099259		099266	
ICM 4 Intenzivno crna RAL 9005	13,95	17,44	14,25	17,81	18,70	23,38
	116895 *		116901		116918 *	
OCM 5 Vinsko crvena RAL 3009	13,95	17,44	14,25	17,81	18,70	23,38
	116956 *		116963 *		116970 *	
ZHM 6 Zeleno smeđa RAL 7013	13,95	17,44	14,25	17,81	18,70	23,38
	111609 *		111616		111623	
BHM 7 Srebrna RAL 9006	13,95	17,44	14,25	17,81	18,70	23,38
	116833 *		116840 *		116857 *	
BM 8 Bijela RAL 9010	13,95	17,44	14,25	17,81	18,70	23,38
	135889 *		135896		135902 *	
ZSM 9 Cink siva RAL extra	13,95	17,44	14,25	17,81	18,70	23,38
	136060 *		136077 *		136084 *	
MHM 10 Bakreno smeđa RAL 8004	13,95	17,44	14,25	17,81	18,70	23,38
	135940		135957		135964	
MZM 11 Mahunasto zelena RAL 6005	13,95	17,44	14,25	17,81	18,70	23,38
	136008 *		136015 *		136022 *	
BHTM 12 Tamno srebrna RAL 9007	13,95	17,44	14,25	17,81	18,70	23,38
	135827 *		135834 *		135841 *	
Pak. u kom 	15		15		10	
Pak. u kom 	450		450		200	

* Proizvodnja po narudžbi



ALUMINIUM W.15

MATT 3D EFFECT

NOVI PRIČVRŠNI
SISTEM FEDER OMOGUĆUJE
LAGANO OKRETANJE KOLJENA
DO TRAJENOG SMJERA
TE JE POUZDANO U SVAKOJ
POZICIJI. LAGANA MONTAŽA NA
BILO KAKVO KOLJENO
BEZ NITANJA.



①



②



③





ALUMINIUM W.15

MATT 3D EFFECT

INOX ZADRŽAČ SMEĆA

N-NZN



Nominalna veličina	EAN broj narudžbe	Pakiranje u kom		Cijena [€/kom]	
				Bez PDV	S PDV
60	001153	30	2 160	5,55	6,94
80	001160	20	1 440	5,60	7,00
100	001177	15	1 080	5,70	7,13
120	001184	10	720	6,20	7,75
150	001191	5	360	9,80	12,25



ALUMINIUM W.15

MATT 3D EFFECT

SABIRNI KOTLIĆ DESIGN

W.15-WKLZ DE

Nominalna veličina	80		100		120	
	Bez PDV	S PDV	Bez PDV	S PDV	Bez PDV	S PDV
ANM 1 Antracit RAL 7016	103,90	129,88	103,90	129,88	109,20	136,50
	093677 *		093721		093776 *	
TMM 2 Testa di Moro RAL 8028	103,90	129,88	103,90	129,88	109,20	136,50
	100634 *		100689 *		100733 *	
SSM 3 Svijetlo siva RAL 7005	103,90	129,88	103,90	129,88	109,20	136,50
	100481 *		100535 *		100580 *	
ICM 4 Intenzivno crna RAL 9005	103,90	129,88	103,90	129,88	109,20	136,50
	138606 *		138651 *		138705 *	
OCM 5 Vinsko crvena RAL 3009	103,90	129,88	103,90	129,88	109,20	136,50
	139054 *		139108 *		139153 *	
ZHM 6 Zeleno smeđa RAL 7013	103,90	129,88	103,90	129,88	109,20	136,50
	111647 *		111692 *		111746 *	
BHM 7 Srebrna RAL 9006	103,90	129,88	103,90	129,88	109,20	136,50
	138156 *		138200 *		138255 *	
BM 8 Bijela RAL 9010	103,90	129,88	103,90	129,88	109,20	136,50
	138453 *		138507 *		138552 *	
ZSM 9 Cink siva RAL extra	103,90	129,88	103,90	129,88	109,20	136,50
	139207 *		139252 *		139306 *	
MHM 10 Bakreno smeđa RAL 8004	103,90	129,88	103,90	129,88	109,20	136,50
	138750 *		138804 *		138859 *	
MZM 11 Mahunasto zelena RAL 6005	103,90	129,88	103,90	129,88	109,20	136,50
	138903 *		138958 *		139009 *	
BHTM 12 Tamno srebrna RAL 9007	103,90	129,88	103,90	129,88	109,20	136,50
	138309 *		138354 *		138408 *	
Pak. u kom 	2		2		2	
Pak. u kom 	36		36		36	

* Proizvodnja po narudžbi



SABIRNI KOTLIĆ DESIGN EKSCENTRIČNI

W.15-WKLZ DX



Nominalna veličina	80		100		120	
	Bez PDV	S PDV	Bez PDV	S PDV	Bez PDV	S PDV
ANM 1 Antracit RAL 7016	119,60	149,50	119,60	149,50	130,00	162,50
	093660 *		093714		093769 *	
TMM 2 Testa di Moro RAL 8028	119,60	149,50	119,60	149,50	130,00	162,50
	100627 *		100672 *		100726 *	
SSM 3 Svijetlo siva RAL 7005	119,60	149,50	119,60	149,50	130,00	162,50
	100474 *		100528 *		100573 *	
ICM 4 Intenzivno crna RAL 9005	119,60	149,50	119,60	149,50	130,00	162,50
	138613 *		138668 *		138712 *	
OCM 5 Vinsko crvena RAL 3009	119,60	149,50	119,60	149,50	130,00	162,50
	139061 *		139115 *		139160 *	
ZHM 6 Zeleno smeđa RAL 7013	119,60	149,50	119,60	149,50	130,00	162,50
	111630 *		111685 *		111739 *	
BHM 7 Srebrna RAL 9006	119,60	149,50	119,60	149,50	130,00	162,50
	138163 *		138217 *		138262 *	
BM 8 Bijela RAL 9010	119,60	149,50	119,60	149,50	130,00	162,50
	138460 *		138514 *		138569 *	
ZSM 9 Cink siva RAL extra	119,60	149,50	119,60	149,50	130,00	162,50
	139214 *		139269 *		139313 *	
MHM 10 Bakreno smeđa RAL 8004	119,60	149,50	119,60	149,50	130,00	162,50
	138767 *		138811 *		138866 *	
MZM 11 Mahunasto zelena RAL 6005	119,60	149,50	119,60	149,50	130,00	162,50
	138910 *		138965 *		139016 *	
BHTM 12 Tamno srebrna RAL 9007	119,60	149,50	119,60	149,50	130,00	162,50
	138316 *		138361 *		138415 *	
Pak. u kom 	2		2		2	
Pak. u kom 	36		36		36	

* Proizvodnja po narudžbi

ALUMINIUM W.15

MATT 3D EFFECT

SABIRNI KOTLIĆ KUBICKI

W.15-WKLZ KU

Nominalna veličina	80		100		120	
	Bez PDV	S PDV	Bez PDV	S PDV	Bez PDV	S PDV
ANM 1 Antracit RAL 7016	133,10	166,38	133,10	166,38	150,80	188,50
	093684 *		093738 *		093783 *	
TMM 2 Testa di Moro RAL 8028	133,10	166,38	133,10	166,38	150,80	188,50
	100641 *		100696 *		100740 *	
SSM 3 Svijetlo siva RAL 7005	133,10	166,38	133,10	166,38	150,80	188,50
	100498 *		100542 *		100597 *	
ICM 4 Intenzivno crna RAL 9005	133,10	166,38	133,10	166,38	150,80	188,50
	138620 *		138675 *		138729 *	
OCM 5 Vinsko crvena RAL 3009	133,10	166,38	133,10	166,38	150,80	188,50
	139078 *		139122 *		139177 *	
ZHM 6 Zeleno smeđa RAL 7013	133,10	166,38	133,10	166,38	150,80	188,50
	111654 *		111708 *		111753 *	
BHM 7 Srebrna RAL 9006	133,10	166,38	133,10	166,38	150,80	188,50
	138170 *		138224 *		138279 *	
BM 8 Bijela RAL 9010	133,10	166,38	133,10	166,38	150,80	188,50
	138477 *		138521 *		138576 *	
ZSM 9 Cink siva RAL extra	133,10	166,38	133,10	166,38	150,80	188,50
	139221 *		139276 *		139320 *	
MHM 10 Bakreno smeđa RAL 8004	133,10	166,38	133,10	166,38	150,80	188,50
	138774 *		138828 *		138873 *	
MZM 11 Mahunasto zelena RAL 6005	133,10	166,38	133,10	166,38	150,80	188,50
	138927 *		138972 *		139023 *	
BHTM 12 Tamno srebrna RAL 9007	133,10	166,38	133,10	166,38	150,80	188,50
	138323 *		138378 *		138422 *	
Pak. u kom 	2		2		2	
Pak. u kom 	36		36		36	



* Proizvodnja po narudžbi



SABIRNI KOTLIĆ KUBICKI EKSCENTRIČAN

W.15-WKLZ KX



Nominalna veličina	80		100		120	
	Bez PDV	S PDV	Bez PDV	S PDV	Bez PDV	S PDV
ANM 1 Antracit RAL 7016	140,40	175,50	140,40	175,50	150,80	188,50
	093707 *		093752		093806 *	
TMM 2 Testa di Moro RAL 8028	140,40	175,50	140,40	175,50	150,80	188,50
	100665 *		100719		100764 *	
SSM 3 Svijetlo siva RAL 7005	140,40	175,50	140,40	175,50	150,80	188,50
	100511 *		100566		100610 *	
ICM 4 Intenzivno crna RAL 9005	140,40	175,50	140,40	175,50	150,80	188,50
	138637 *		138682 *		138736 *	
OCM 5 Vinsko crvena RAL 3009	140,40	175,50	140,40	175,50	150,80	188,50
	139085 *		139139 *		139184 *	
ZHM 6 Zeleno smeđa RAL 7013	140,40	175,50	140,40	175,50	150,80	188,50
	111678 *		111722		111777 *	
BHM 7 Srebrna RAL 9006	140,40	175,50	140,40	175,50	150,80	188,50
	138187 *		138231 *		138286 *	
BM 8 Bijela RAL 9010	140,40	175,50	140,40	175,50	150,80	188,50
	138484 *		138538 *		138583 *	
ZSM 9 Cink siva RAL extra	140,40	175,50	140,40	175,50	150,80	188,50
	139238 *		139283 *		139337 *	
MHM 10 Bakreno smeđa RAL 8004	140,40	175,50	140,40	175,50	150,80	188,50
	138781 *		138835 *		138880 *	
MZM 11 Mahunasto zelena RAL 6005	140,40	175,50	140,40	175,50	150,80	188,50
	138934 *		138989 *		139030 *	
BHTM 12 Tamno srebrna RAL 9007	140,40	175,50	140,40	175,50	150,80	188,50
	138330 *		138385 *		138439 *	
Pak. u kom 	2		2		2	
Pak. u kom 	36		36		36	



* Proizvodnja po narudžbi

ALUMINIUM W.15

MATT 3D EFFECT

SABIRNI KOTLIĆ KUBICKI EKSCENTRIČNI S OTVOROM W.15-WKLZ KXV





Nominalna veličina	80		100		120	
	Bez PDV	S PDV	Bez PDV	S PDV	Bez PDV	S PDV
ANM 1 Antracit RAL 7016	166,40	208,00	166,40	208,00	176,80	221,00
	093691 *		093745 *		093790 *	
TMM 2 Testa di Moro RAL 8028	166,40	208,00	166,40	208,00	176,80	221,00
	100658 *		100702 *		100757 *	
SSM 3 Svijetlo siva RAL 7005	166,40	208,00	166,40	208,00	176,80	221,00
	100504 *		100559 *		100603 *	
ICM 4 Intenzivno crna RAL 9005	166,40	208,00	166,40	208,00	176,80	221,00
	138644 *		138699 *		138743 *	
OCM 5 Vinsko crvena RAL 3009	166,40	208,00	166,40	208,00	176,80	221,00
	139092 *		139146 *		139191 *	
ZHM 6 Zeleno smeđa RAL 7013	166,40	208,00	166,40	208,00	176,80	221,00
	111661 *		111715 *		111760 *	
BHM 7 Srebrna RAL 9006	166,40	208,00	166,40	208,00	176,80	221,00
	138194 *		138248 *		138293 *	
BM 8 Bijela RAL 9010	166,40	208,00	166,40	208,00	176,80	221,00
	138491 *		138545 *		138590 *	
ZSM 9 Cink siva RAL extra	166,40	208,00	166,40	208,00	176,80	221,00
	139245 *		139290 *		139344 *	
MHM 10 Bakreno smeđa RAL 8004	166,40	208,00	166,40	208,00	176,80	221,00
	138798 *		138842 *		138897 *	
MZM 11 Mahunasto zelena RAL 6005	166,40	208,00	166,40	208,00	176,80	221,00
	138941 *		138996 *		139047 *	
BHTM 12 Tamno srebrna RAL 9007	166,40	208,00	166,40	208,00	176,80	221,00
	138347 *		138392 *		138446 *	
Pak. u kom 	2		2		2	
Pak. u kom 	36		36		36	

* Proizvodnja po narudžbi

GUMA ZA BRTLJENJE SABIRNOG KOTLIĆA

P-PKLZ T



Nominalna veličina	EAN broj narudžbe	Pakiranje u kom		Cijena [€/kom]	
				Bez PDV	S PDV
IC 70-85	077103	5	600	4,00	5,00
IC 100-110	077110	5	600	4,10	5,13
IC 110-125	077097	5	600	4,20	5,25
PS 70-85	077134	5	600	4,50	5,63
PS 100-110	077141	5	600	4,90	6,13
PS 110-125	077127	5	600	5,00	6,25

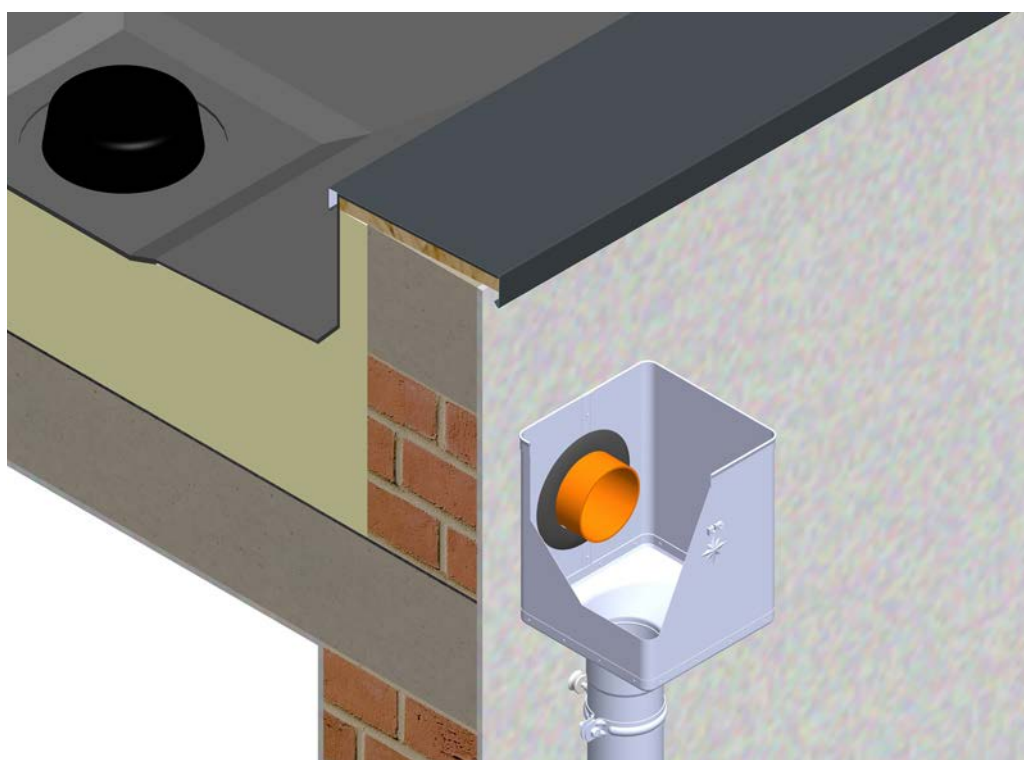

ALUMINIUM W.15

MATT 3D EFFECT

VARENO KOLJENO 72°

W.15-WK

Nominalna veličina	80		100		120	
	Bez PDV	S PDV	Bez PDV	S PDV	Bez PDV	S PDV
ANM 1 Antracit RAL 7016	9,35	11,69	10,00	12,50	15,20	19,00
	093523		093547		093561	
TMM 2 Testa di Moro RAL 8028	9,35	11,69	10,00	12,50	15,20	19,00
	099129		099136		099143	
SSM 3 Svijetlo siva RAL 7005	9,35	11,69	10,00	12,50	15,20	19,00
	099099		099105		099112	
ICM 4 Intenzivno crna RAL 9005	9,35	11,69	10,00	12,50	15,20	19,00
	116567		116574		116581 *	
OCM 5 Vinsko crvena RAL 3009	9,35	11,69	10,00	12,50	15,20	19,00
	116598 *		116604 *		116611 *	
ZHM 6 Zeleno smeđa RAL 7013	9,35	11,69	10,00	12,50	15,20	19,00
	111517		111531		111555	
BHM 7 Srebrna RAL 9006	9,35	11,69	10,00	12,50	15,20	19,00
	116536 *		116543 *		116550 *	
BM 8 Bijela RAL 9010	9,35	11,69	10,00	12,50	15,20	19,00
	135674 *		135681		135698 *	
ZSM 9 Cink siva RAL extra	9,35	11,69	10,00	12,50	15,20	19,00
	135766 *		135773 *		135780 *	
MHM 10 Bakreno smeđa RAL 8004	9,35	11,69	10,00	12,50	15,20	19,00
	135704		135711		135728	
MZM 11 Mahunasto zelena RAL 6005	9,35	11,69	10,00	12,50	15,20	19,00
	135735 *		135742 *		135759 *	
BHTM 12 Tamno srebrna RAL 9007	9,35	11,69	10,00	12,50	15,20	19,00
	135643 *		135650 *		135667 *	
Pak. u kom 	4		4		2	
Pak. u kom 	240		120		120	

* Proizvodnja po narudžbi



ALUMINIUM
W.15

VARENO KOLJENO 85°

W.15-WKR

Nominalna veličina	80		100		120	
	Bez PDV	S PDV	Bez PDV	S PDV	Bez PDV	S PDV
ANM 1 Antracit RAL 7016	11,65	14,56	14,55	18,19	18,70	23,38
	093530 *		093554		093578 *	
TMM 2 Testa di Moro RAL 8028	11,65	14,56	14,55	18,19	18,70	23,38
	099167 *		099181		099204 *	
SSM 3 Svijetlo siva RAL 7005	11,65	14,56	14,55	18,19	18,70	23,38
	099150 *		099174		099198 *	
ICM 4 Intenzivno crna RAL 9005	11,65	14,56	14,55	18,19	18,70	23,38
	116628 *		116635 *		116642 *	
OCM 5 Vinsko crvena RAL 3009	11,65	14,56	14,55	18,19	18,70	23,38
	116659 *		116666 *		116673 *	
ZHM 6 Zeleno smeđa RAL 7013	11,65	14,56	14,55	18,19	18,70	23,38
	111524 *		111548		111562 *	
BHM 7 Srebrna RAL 9006	11,65	14,56	14,55	18,19	18,70	23,38
	116680 *		116697 *		116703 *	
BM 8 Bijela RAL 9010	11,65	14,56	14,55	18,19	18,70	23,38
	136275 *		136282		136299 *	
ZSM 9 Cink siva RAL extra	11,65	14,56	14,55	18,19	18,70	23,38
	136367 *		136374 *		136381 *	
MHM 10 Bakreno smeđa RAL 8004	11,65	14,56	14,55	18,19	18,70	23,38
	136305 *		136312 *		136329 *	
MZM 11 Mahunasto zelena RAL 6005	11,65	14,56	14,55	18,19	18,70	23,38
	136336 *		136343 *		136350 *	
BHTM 12 Tamno srebrna RAL 9007	11,65	14,56	14,55	18,19	18,70	23,38
	136224 *		136251 *		136268 *	
Pak. u kom 	4		4		4	
Pak. u kom 	240		120		120	

* Proizvodnja po narudžbi





ALUMINIUM W.15

MATT 3D EFFECT

VARENO KOLJENO 40°

W.15-WKT

Nominalna veličina	80		100		120	
	Bez PDV	S PDV	Bez PDV	S PDV	Bez PDV	S PDV
ANM 1 Antracit RAL 7016	9,25	11,56	11,45	14,31	15,50	19,38
	093844		093851		093868	
TMM 2 Testa di Moro RAL 8028	9,25	11,56	11,45	14,31	15,50	19,38
	099440		099464		099471 *	
SSM 3 Svijetlo siva RAL 7005	9,25	11,56	11,45	14,31	15,50	19,38
	099433		099457		099488 *	
ICM 4 Intenzivno crna RAL 9005	9,25	11,56	11,45	14,31	15,50	19,38
	116741 *		116758 *		116765 *	
OCM 5 Vinsko crvena RAL 3009	9,25	11,56	11,45	14,31	15,50	19,38
	116772 *		116789 *		116796 *	
ZHM 6 Zeleno smeđa RAL 7013	9,25	11,56	11,45	14,31	15,50	19,38
	111814		111821		111838 *	
BHM 7 Srebrna RAL 9006	9,25	11,56	11,45	14,31	15,50	19,38
	116710 *		116727 *		116734 *	
BM 8 Bijela RAL 9010	9,25	11,56	11,45	14,31	15,50	19,38
	136428 *		136435		136442 *	
ZSM 9 Cink siva RAL extra	9,25	11,56	11,45	14,31	15,50	19,38
	136510 *		136527 *		136534 *	
MHM 10 Bakreno smeđa RAL 8004	9,25	11,56	11,45	14,31	15,50	19,38
	136459 *		136466 *		136473 *	
MZM 11 Mahunasto zelena RAL 6005	9,25	11,56	11,45	14,31	15,50	19,38
	136480 *		136497 *		136503 *	
BHTM 12 Tamno srebrna RAL 9007	9,25	11,56	11,45	14,31	15,50	19,38
	136398 *		136404 *		136411 *	
Pak. u kom 	4		4		4	
Pak. u kom 	240		120		120	

* Proizvodnja po narudžbi



ALUMINIUM W.15

MATT 3D EFFECT

ODVODNA CIJEV [s=0,70]

W.15-WZR





Nominalna veličina	80		100		100		120	
Dužina u m	3,0		3,0		4,0		3,0	
Cijena u €/m	Bez PDV	S PDV	Bez PDV	S PDV	Bez PDV	S PDV	Bez PDV	S PDV
ANM Antracit RAL 7016	7,75	9,69	8,30	10,38	8,30	10,38	11,20	14,00
	094131		094148		094155		094162	
TMM Testa di Moro RAL 8028	7,75	9,69	8,30	10,38	8,30	10,38	11,20	14,00
	100177		100184		100191		100207	
SSM Svijetlo siva RAL 7005	7,75	9,69	8,30	10,38	8,30	10,38	11,20	14,00
	100139		100146		100153		100160	
ICM Intenzivno crna RAL 9005	7,75	9,69	8,30	10,38	8,30	10,38	11,20	14,00
	115294		115300		115317		115324	
OCM Vinsko crvena RAL 3009	7,75	9,69	8,30	10,38	8,30	10,38	11,20	14,00
	115331		115348		115355		115362	
ZHM Zeleno smeđa RAL 7013	7,75	9,69	8,30	10,38	8,30	10,38	11,20	14,00
	112088		112095		112101 *		112118	
BHM Srebrna RAL 9006	7,75	9,69	8,30	10,38	8,30	10,38	11,20	14,00
	115249		115256		115263		115287	
BM Bijela RAL 9010	7,75	9,69	8,30	10,38	8,30	10,38	11,20	14,00
	132598		132604		132611		132628 *	
ZSM Cink siva RAL extra	7,75	9,69	8,30	10,38	8,30	10,38	11,20	14,00
	132680 *		132727 *		132734 *		132789 *	
MHM Bakreno smeđa RAL 8004	7,75	9,69	8,30	10,38	8,30	10,38	11,20	14,00
	132673 *		132703 *		132758 *		132765 *	
MZM Mahunasto zelena RAL 6005	7,75	9,69	8,30	10,38	8,30	10,38	11,20	14,00
	132697 *		132710 *		132741 *		132772 *	
BHTM Tamno srebrna RAL 9007	7,75	9,69	8,30	10,38	8,30	10,38	11,20	14,00
	132635 *		132642 *		132659 *		132666 *	
Pak. u m 	18		18		24		18	
Pak. u m 	216		180		240		144	

* Proizvodnja po narudžbi

PVC IZLJEVNI RUKAV

SD-ZR FOLIA KJG



Nominalna veličina	Dužina u m	EAN broj narudžbe	Pakiranje u m		Cijena [€/kom]	
					Bez PDV	S PDV
60-150	100,0	139726	100	6 000	0,38	0,48

ALUMINIUM W.15

MATT 3D EFFECT

KOLJENO ODSKOČNO

W.15-WKO

Nominalna veličina	80		100		120	
	Bez PDV	S PDV	Bez PDV	S PDV	Bez PDV	S PDV
ANM 1 Antracit RAL 7016	11,45	14,31	14,00	17,50	16,60	20,75
	093813		093820		093837	
TMM 2 Testa di Moro RAL 8028	11,45	14,31	14,00	17,50	16,60	20,75
	099389 *		099402 *		099426 *	
SSM 3 Svijetlo siva RAL 7005	11,45	14,31	14,00	17,50	16,60	20,75
	099372		099396		099419 *	
ICM 4 Intenzivno crna RAL 9005	11,45	14,31	14,00	17,50	16,60	20,75
	118639 *		118646		118653 *	
OCM 5 Vinsko crvena RAL 3009	11,45	14,31	14,00	17,50	16,60	20,75
	118660 *		118677 *		118684 *	
ZHM 6 Zeleno smeđa RAL 7013	11,45	14,31	14,00	17,50	16,60	20,75
	111784 *		111791 *		111807 *	
BHM 7 Srebrna RAL 9006	11,45	14,31	14,00	17,50	16,60	20,75
	118608 *		118615 *		118622 *	
BM 8 Bijela RAL 9010	11,45	14,31	14,00	17,50	16,60	20,75
	136213 *		136220		136237 *	
ZSM 9 Cink siva RAL extra	11,45	14,31	14,00	17,50	16,60	20,75
	136152 *		136169 *		136176 *	
MHM 10 Bakreno smeđa RAL 8004	11,45	14,31	14,00	17,50	16,60	20,75
	136091 *		136107		136114 *	
MZM 11 Mahunasto zelena RAL 6005	11,45	14,31	14,00	17,50	16,60	20,75
	136121 *		136138 *		136145 *	
BHTM 12 Tamno srebrna RAL 9007	11,45	14,31	14,00	17,50	16,60	20,75
	136183 *		136190 *		136206 *	
Pak. u kom 	4		4		2	
Pak. u kom 	240		120		120	



* Proizvodnja po narudžbi



REDUKCIJA CIJEVI 72°

W.15-WZO





Nominalna veličina	80/80		100/80		100/100	
	Bez PDV	S PDV	Bez PDV	S PDV	Bez PDV	S PDV
ANM 1 Antracit RAL 7016	40,00	50,00	41,10	51,38	41,50	51,88
	094070 *		094087 *		094094	
TMM 2 Testa di Moro RAL 8028	40,00	50,00	41,10	51,38	41,50	51,88
	100412 *		100429 *		100436 *	
SSM 3 Svijetlo siva RAL 7005	40,00	50,00	41,10	51,38	41,50	51,88
	100351 *		100368 *		100375 *	
ICM 4 Intenzivno crna RAL 9005	40,00	50,00	41,10	51,38	41,50	51,88
	119018 *		119049 *		119087 *	
OCM 5 Vinsko crvena RAL 3009	40,00	50,00	41,10	51,38	41,50	51,88
	119025 *		119063 *		119094 *	
ZHM 6 Zeleno smeđa RAL 7013	40,00	50,00	41,10	51,38	41,50	51,88
	112026 *		112033 *		112040 *	
BHM 7 Srebrna RAL 9006	40,00	50,00	41,10	51,38	41,50	51,88
	119032 *		119056 *		119070 *	
BM 8 Bijela RAL 9010	40,00	50,00	41,10	51,38	41,50	51,88
	137258 *		157265 *		137272 *	
ZSM 9 Cink siva RAL extra	40,00	50,00	41,10	51,38	41,50	51,88
	137432 *		137449 *		137456 *	
MHM 10 Bakreno smeđa RAL 8004	40,00	50,00	41,10	51,38	41,50	51,88
	137319 *		137326 *		137333 *	
MZM 11 Mahunasto zelena RAL 6005	40,00	50,00	41,10	51,38	41,50	51,88
	137371 *		137388 *		137395 *	
BHTM 12 Tamno srebrna RAL 9007	40,00	50,00	41,10	51,38	41,50	51,88
	137197 *		137203 *		137210 *	
Pak. u kom 	4		4		4	
Pak. u kom 	120		120		120	

* Proizvodnja po narudžbi

REDUKCIJA CIJEVI 72°

W.15-WZO

Nominalna veličina	120/80		120/100		120/120	
	Bez PDV	S PDV	Bez PDV	S PDV	Bez PDV	S PDV
ANM 1 Antracit RAL 7016	44,80	56,00	45,30	56,63	45,60	57,00
	094100 *		094117 *		094124 *	
TMM 2 Testa di Moro RAL 8028	44,80	56,00	45,30	56,63	45,60	57,00
	100443 *		100450 *		100467 *	
SSM 3 Svijetlo siva RAL 7005	44,80	56,00	45,30	56,63	45,60	57,00
	100382 *		100399 *		100405 *	
ICM 4 Intenzivno crna RAL 9005	44,80	56,00	45,30	56,63	45,60	57,00
	119117 *		119148 *		119179 *	
OCM 5 Vinsko crvena RAL 3009	44,80	56,00	45,30	56,63	45,60	57,00
	119100 *		119155 *		119186 *	
ZHM 6 Zeleno smeđa RAL 7013	44,80	56,00	45,30	56,63	45,60	57,00
	112057 *		112064 *		112071 *	
BHM 7 Srebrna RAL 9006	44,80	56,00	45,30	56,63	45,60	57,00
	119124 *		119131 *		119162 *	
BM 8 Bijela RAL 9010	44,80	56,00	45,30	56,63	45,60	57,00
	137289 *		137296 *		137302 *	
ZSM 9 Cink siva RAL extra	44,80	56,00	45,30	56,63	45,60	57,00
	137463 *		137470 *		137487 *	
MHM 10 Bakreno smeđa RAL 8004	44,80	56,00	45,30	56,63	45,60	57,00
	137340 *		137357 *		137364 *	
MZM 11 Mahunasto zelena RAL 6005	44,80	56,00	45,30	56,63	45,60	57,00
	137401 *		137418 *		137425 *	
BHTM 12 Tamno srebrna RAL 9007	44,80	56,00	45,30	56,63	45,60	57,00
	137227 *		137234 *		137241 *	
Pak. u kom 	3		3		3	
Pak. u kom 	90		90		90	

* Proizvodnja po narudžbi



ZVODOVÁ OBJÍMKA M10

W.15-WOB

Nominalna veličina	80		100		120	
	Bez PDV	S PDV	Bez PDV	S PDV	Bez PDV	S PDV
ANM 1 Antracit RAL 7016	3,40	4,25	3,55	4,44	4,05	5,06
	093875		093882		093899	
TMM 2 Testa di Moro RAL 8028	3,40	4,25	3,55	4,44	4,05	5,06
	099761		099778		099785	
SSM 3 Svijetlo siva RAL 7005	3,40	4,25	3,55	4,44	4,05	5,06
	099730		099747		099754	
ICM 4 Intenzivno crna RAL 9005	3,40	4,25	3,55	4,44	4,05	5,06
	118530		118547		118554 *	
OCM 5 Vinsko crvena RAL 3009	3,40	4,25	3,55	4,44	4,05	5,06
	118561 *		118578 *		118585 *	
ZHM 6 Zeleno smeđa RAL 7013	3,40	4,25	3,55	4,44	4,05	5,06
	111845		111852		111869	
BHM 7 Srebrna RAL 9006	3,40	4,25	3,55	4,44	4,05	5,06
	118509 *		118516 *		118523 *	
BM 8 Bijela RAL 9010	3,40	4,25	3,55	4,44	4,05	5,06
	136572 *		136589		136596 *	
ZSM 9 Cink siva RAL extra	3,40	4,25	3,55	4,44	4,05	5,06
	136664 *		136671 *		136688 *	
MHM 10 Bakreno smeđa RAL 8004	3,40	4,25	3,55	4,44	4,05	5,06
	136602		136619		136626	
MZM 11 Mahunasto zelena RAL 6005	3,40	4,25	3,55	4,44	4,05	5,06
	136633 *		136640 *		136657 *	
BHTM 12 Tamno srebrna RAL 9007	3,40	4,25	3,55	4,44	4,05	5,06
	136541 *		136558 *		136565 *	
Pak. u kom 	10		10		10	
Pak. u kom 	1 200		1 200		1 200	



* Proizvodnja po narudžbi





ALUMINIUM W.15

MATT 3D EFFECT

INOX VIJAK ZA OBUJMICU M8x30

P-POB-NSK



Nominalna veličina	EAN broj narudžbe	Pakiranje u kom		Cijena [€/kom]	
				Bez PDV	S PDV
M8 x 30 *	139658	1	–	0,25	0,31



* Proizvodnja po narudžbi

VIJAK ZA OBUJMICU TORX M10

P-POB-HT





ALUMINIUM
W.15

Nominalna veličina	EAN broj narudžbe	Pakiranje u kom		Cijena [€/kom]	
				Bez PDV	S PDV
80	002464	100	40 000	1,00	1,25
140	002471	100	28 000	1,25	1,56
200	002488	100	20 000	1,55	1,94
250	002495	100	16 000	1,70	2,13
300	002501	100	11 200	1,70	2,13

TIPLA M10

P-POB-HN DB





Nominalna veličina	EAN broj narudžbe	Pakiranje u kom		Cijena [€/kom]	
				Bez PDV	S PDV
120	002426	100	25 000	0,40	0,50

TIPLA S LAMELOM M10

P-POB-HN DB





Nominalna veličina	EAN broj narudžbe	Pakiranje u kom		Cijena [€/kom]	
				Bez PDV	S PDV
180	002433	100	12 000	0,42	0,53
240	002440	100	12 000	0,50	0,63
280	002457	100	12 000	0,53	0,66

KOMBINIRANI VIJAK TORX M10

P-POB-ZT/SZ



Nominalna veličina	EAN broj narudžbe	Pakiranje u kom		Cijena [€/kom]	
				Bez PDV	S PDV
140	002587	50	10 400	0,45	0,56
180	002594	50	10 400	0,55	0,69



ALUMINIUM W.15

MATT 3D EFFECT

TIPLA ZA IZOLACIJU M10

P-POB-HN IZOL





Nominalna veličina	EAN broj narudžbe	Pakiranje u kom		Cijena [€/kom]	
				Bez PDV	S PDV
M10 x 96	001207	25	2 625	2,95	3,69

KLIN SA PVC TIPLOM ZA OPEKU BEZ IZOLACIJE

P-POB-HN WDVS140 M10





Nominalna veličina	EAN broj narudžbe	Pakiranje u kom		Cijena [€/kom]	
				Bez PDV	S PDV
140	144843	1/5	750	4,80	6,00

KLIN SA PVC TIPLOM ZA OPEKU SA IZOLACIJOM

P-POB-HN WDVS300 M10





Nominalna veličina	EAN broj narudžbe	Pakiranje u kom		Cijena [€/kom]	
				Bez PDV	S PDV
300	144850	1/5	500	7,80	9,75

UNI NASTAVAK OD NEHRĐAJUČEG ČELIKA ZA PRIČVRŠČIVANJE OB M10

P-POB-HN PLAT M10



Nominalna veličina	EAN broj narudžbe	Pakiranje u kom		Cijena [€/kom]	
				Bez PDV	S PDV
M10	144836	25/500	5 000	3,35	4,19



ALUMINIUM W.15

MATT 3D EFFECT

NAVOJNA ŠIPKA M10

P-POB-ZT





Nominalna veličina	EAN broj narudžbe	Pakiranje u kom		Cijena [€/kom]	
				Bez PDV	S PDV
60	002556	100	20 800	0,20	0,25
100	002563	100	15 600	0,30	0,38
150	002570	50	10 400	0,55	0,69

MONTAŽNA PLOČICA M10

P-POB-ZT MP













Nominalna veličina	EAN broj narudžbe	Pakiranje u kom		Cijena [€/kom]	
				Bez PDV	S PDV
80 x 30	002518	25	5 200	1,15	1,44

ZAŠTITNI POKLOPAC OBUJMIC

P-POB-HT AKG



Nominalna veličina	EAN broj narudžbe	Pakiranje u kom		Cijena [€/kom]	
				Bez PDV	S PDV
 29 x 13	002280	50	16 800	0,25	0,31
 29 x 13	002211	50	16 800	0,25	0,31
 29 x 13	002235	50	16 800	0,25	0,31
 29 x 13	002266	50	16 800	0,25	0,31
 29 x 13	002242	50	16 800	0,25	0,31
 29 x 13	002228	50	16 800	0,25	0,31
 29 x 13	002273	50	16 800	0,25	0,31
 29 x 13	002259	50	16 800	0,25	0,31
 29 x 13	002297	50	16 800	0,25	0,31

ZADRŽAČ VODE+SÍTKO

W.15-WZVS



Nominalna veličina	80		100		120	
	Bez PDV	S PDV	Bez PDV	S PDV	Bez PDV	S PDV
ANM 1 Antracit RAL 7016	26,50	33,13	29,10	36,38	43,70	54,63
	094216		094223		094230	
TMM 2 Testa di Moro RAL 8028	26,50	33,13	29,10	36,38	43,70	54,63
	100320		100337		100344	
SSM 3 Svijetlo siva RAL 7005	26,50	33,13	29,10	36,38	43,70	54,63
	100290		100306		100313	
ICM 4 Intenzivno crna RAL 9005	26,50	33,13	29,10	36,38	43,70	54,63
	114419		114426		114433	
OCM 5 Vinsko crvena RAL 3009	26,50	33,13	29,10	36,38	43,70	54,63
	114389 *		114402 *		114396 *	
ZHM 6 Zeleno smeđa RAL 7013	26,50	33,13	29,10	36,38	43,70	54,63
	112156		112163		112170	
BHM 7 Srebrna RAL 9006	26,50	33,13	29,10	36,38	43,70	54,63
	114440		114457		114464	
BM 8 Bijela RAL 9010	26,50	33,13	29,10	36,38	43,70	54,63
	124883 *		124890		124906 *	
ZSM 9 Cink siva RAL extra	26,50	33,13	29,10	36,38	43,70	54,63
	124975 *		124982 *		124999 *	
MHM 10 Bakreno smeđa RAL 8004	26,50	33,13	29,10	36,38	43,70	54,63
	124913 *		124920 *		124937 *	
MZM 11 Mahunasto zelena RAL 6005	26,50	33,13	29,10	36,38	43,70	54,63
	124944 *		124951 *		124968 *	
BHTM 12 Tamno srebrna RAL 9007	26,50	33,13	29,10	36,38	43,70	54,63
	124852 *		124869 *		124876 *	
Pak. u kom 	2		3		3	
Pak. u kom 	240		90		90	

* Proizvodnja po narudžbi

ALUMINIUM W.15

MATT 3D EFFECT

ZADRŽAČ VODE+HADICA

W.15-WZVHA

Nominalna veličina	80		100		120	
	Bez PDV	S PDV	Bez PDV	S PDV	Bez PDV	S PDV
ANM 1 Antracit RAL 7016	67,60	84,50	67,60	84,50	130,00	162,50
	094186 *		094193		094209 *	
TMM 2 Testa di Moro RAL 8028	67,60	84,50	67,60	84,50	130,00	162,50
	100269 *		100276 *		100283 *	
SSM 3 Svijetlo siva RAL 7005	67,60	84,50	67,60	84,50	130,00	162,50
	100238 *		100245 *		100252 *	
ICM 4 Intenzivno crna RAL 9005	67,60	84,50	67,60	84,50	130,00	162,50
	116116 *		116123 *		116130 *	
OCM 5 Vinsko crvena RAL 3009	67,60	84,50	67,60	84,50	130,00	162,50
	116147 *		116154 *		116161 *	
ZHM 6 Zeleno smeđa RAL 7013	67,60	84,50	67,60	84,50	130,00	162,50
	112132 *		112316 *		112149 *	
BHM 7 Srebrna RAL 9006	67,60	84,50	67,60	84,50	130,00	162,50
	116086 *		116093 *		116109 *	
BM 8 Bijela RAL 9010	67,60	84,50	67,60	84,50	130,00	162,50
	137623 *		137630 *		137647 *	
ZSM 9 Cink siva RAL extra	67,60	84,50	67,60	84,50	130,00	162,50
	137715 *		137722 *		137739 *	
MHM 10 Bakreno smeđa RAL 8004	67,60	84,50	67,60	84,50	130,00	162,50
	137654 *		137661 *		137678 *	
MZM 11 Mahunasto zelena RAL 6005	67,60	84,50	67,60	84,50	130,00	162,50
	137685 *		137692 *		137708 *	
BHTM 12 Tamno srebrna RAL 9007	67,60	84,50	67,60	84,50	130,00	162,50
	137593 *		137609 *		137616 *	
Pak. u kom 		1		1		1
Pak. u kom 		60		60		60



* Proizvodnja po narudžbi



ZAŠTITNA CIJEV S REV. OB

W.15-WOZR



Nominalna veličina	80		100		100	
Dužina u m	1,0		1,0		1,5	
Cijena u €/kom	Bez PDV	S PDV	Bez PDV	S PDV	Bez PDV	S PDV
ANM Antracit RAL 7016	65,50	81,88	51,00	63,75	104,00	130,00
	122742 *		122759 *		122766 *	
TMM Testa di Moro RAL 8028	65,50	81,88	51,00	63,75	104,00	130,00
	123046 *		123053 *		123060 *	
SSM Svijetlo siva RAL 7005	65,50	81,88	51,00	63,75	104,00	130,00
	122995 *		123008 *		123015 *	
ICM Intenzivno crna RAL 9005	65,50	81,88	51,00	63,75	104,00	130,00
	122797 *		122803 *		122810 *	
OCM Vinsko crvena RAL 3009	65,50	81,88	51,00	63,75	104,00	130,00
	122841 *		122858 *		122865 *	
ZHM Zeleno smeđa RAL 7013	65,50	81,88	51,00	63,75	104,00	130,00
	122940 *		122957 *		122964 *	
BHM Srebrna RAL 9006	65,50	81,88	51,00	63,75	104,00	130,00
	122896 *		122902 *		122919 *	
BM Bijela RAL 9010	65,50	81,88	51,00	63,75	104,00	130,00
	123190 *		123206 *		123213 *	
ZSM Cink siva RAL extra	65,50	81,88	51,00	63,75	104,00	130,00
	123145 *		123152 *		123169 *	
MHM Bakreno smeđa RAL 8004	65,50	81,88	51,00	63,75	104,00	130,00
	123244 *		123251 *		123268 *	
MZM Mahunasto zelena RAL 6005	65,50	81,88	51,00	63,75	104,00	130,00
	123091 *		123107 *		123114 *	
BHTM Tamno srebrna RAL 9007	65,50	81,88	51,00	63,75	104,00	130,00
	123336 *		123305 *		123312 *	
Pak. u kom 	1		1		1	
Pak. u kom 	70		60		60	



* Proizvodnja po narudžbi

ALUMINIUM W.15

MATT 3D EFFECT

ZAŠTITNA CIJEV S REV. OB

W.15-WOZR



Nominalna veličina	120		120	
Dužina u m	1,0		1,5	
Cijena u €/kom	Bez PDV	S PDV	Bez PDV	S PDV
ANM Antracit RAL 7016	114,40	143,00	163,30	204,13
	122773 *		122780 *	
TMM Testa di Moro RAL 8028	114,40	143,00	163,30	204,13
	123077 *		123084 *	
SSM Svijetlo siva RAL 7005	114,40	143,00	163,30	204,13
	123022 *		123039 *	
ICM Intenzivno crna RAL 9005	114,40	143,00	163,30	204,13
	122827 *		122834 *	
OCM Vinsko crvena RAL 3009	114,40	143,00	163,30	204,13
	122872 *		122889 *	
ZHM Zeleno smeđa RAL 7013	114,40	143,00	163,30	204,13
	122971 *		122988 *	
BHM Srebrna RAL 9006	114,40	143,00	163,30	204,13
	122926 *		122933 *	
BM Bijela RAL 9010	114,40	143,00	163,30	204,13
	123220 *		123237 *	
ZSM Cink siva RAL extra	114,40	143,00	163,30	204,13
	123176 *		123183 *	
MHM Bakreno smeđa RAL 8004	114,40	143,00	163,30	204,13
	123275 *		123282 *	
MZM Mahunasto zelena RAL 6005	114,40	143,00	163,30	204,13
	123121 *		123138 *	
BHTM Tamno srebrna RAL 9007	114,40	143,00	163,30	204,13
	123329 *		123299 *	
Pak. u kom 	1		1	
Pak. u kom 	40		40	

* Proizvodnja po narudžbi

OBUJMICA S GUMOM M10

P-POB-OZR



Nominalna veličina	EAN broj narudžbe	Pakiranje u kom		Cijena [€/kom]	
				Bez PDV	S PDV
80	002525	25	1 250	1,55	1,94
100	002532	25	1 250	2,00	2,50
120	002549	20	1 000	2,25	2,81

ALUMINIUM W.15

MATT 3D EFFECT

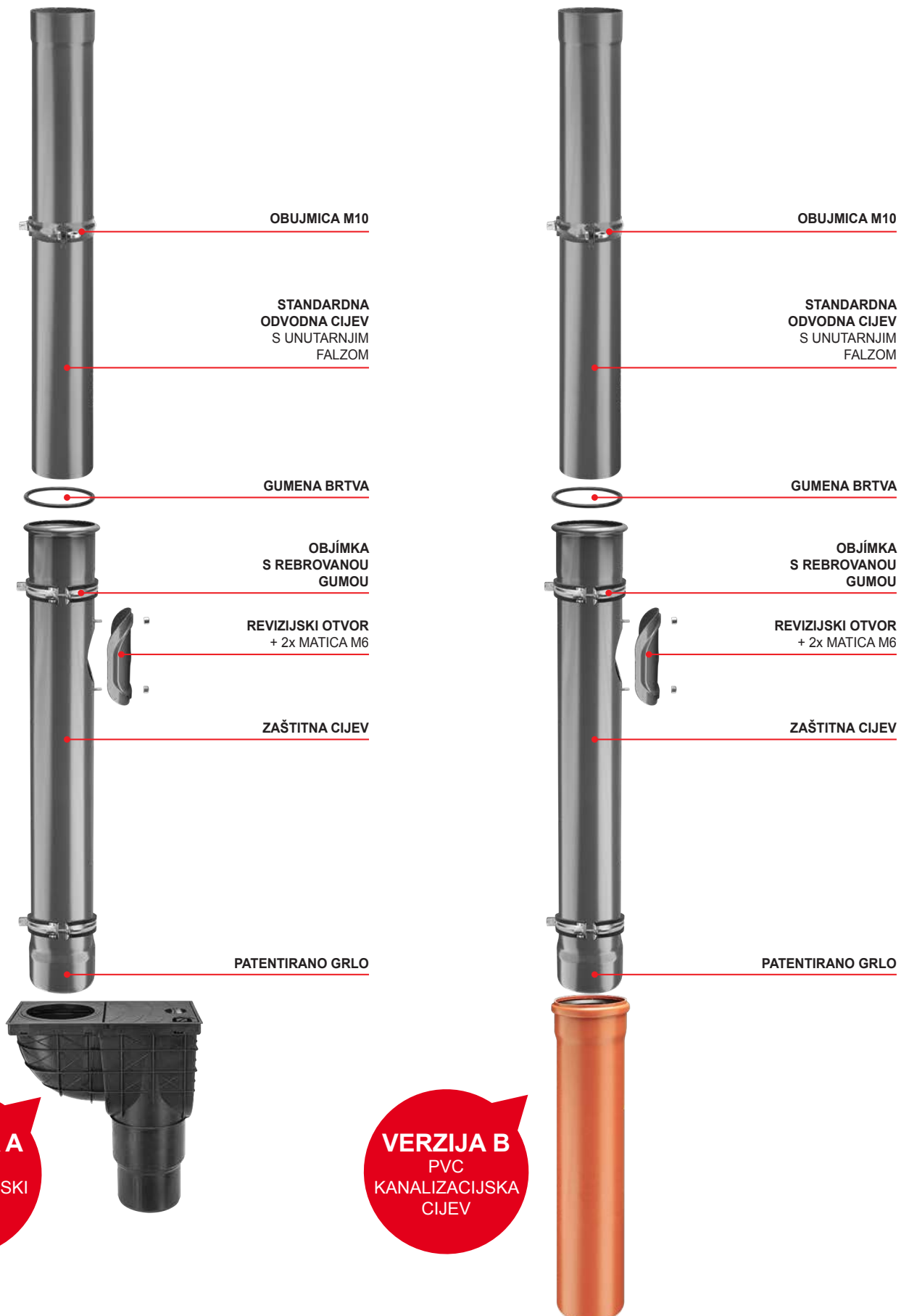

ALUMINIUM
W.15

VERZIJA A
PVC
KANALIZACIJSKI
ISPUST

VERZIJA B
PVC
KANALIZACIJSKA
CIJEV

I. OPĆE ODREDBE

- 1.1. Trgovačko društvo sa sjedištem u Donjem Kneževcu (Općina Gornji Kneževac), Ulica Kralja Andrije II 4, OIB: 73220465365, zastupano po direktoru Eduardu Kollaru ml. (dalje u tekstu: Prodavatelj) objavljuje ove Opće uvjete poslovanja koji se odnose na kupoprodaju odvodnih sistema kao i lakih krovnih pokriva, trapeza, limova krovne opreme, alata, strojeva i ostale robe vezane za krovne sisteme te drugu robu iz prodajno proizvodnog asortimana Prodavatelja (dalje u tekstu: Roba).
- 1.2. Opći uvjeti čine sastavni dio ugovora o kupoprodaji između pojedinog kupca i društva KJG d.o.o. sa sjedištem u Donjem Kneževcu (Općina Gornji Kneževac), Ulica Kralja Andrije II 4, OIB: 73220465365, zastupano po direktoru Eduardu Kollaru ml. kao prodavatelja nastao ugovorenom kupnjom pojedinog proizvoda iz proizvodno-prodajnog asortimana Prodavatelja.
- 1.3. Ovim općim uvjetima reguliraju se međusobna prava i obveze u svrhu neometenog i brzog poslovanja između Kupca i Prodavatelja, a koje će nastati s osnovu kupoprodaje proizvoda iz asortimana Prodavatelja.
- 1.4. Prodavatelj prodaje i isporučuje robu samo u skladu s ovim Općim uvjetima.
- 1.5. U slučajevima naručivanja specifičnih, nestandardnih proizvoda s Kupcem se ugovaraju posebni uvjeti prodaje i plaćanja. Svaka izmjena mora biti sastavljena u pisanoj formi i potpisana od odgovornih osoba ugovornih strana.
- 1.6. Ovi opći uvjeti zajedno s pisanom prihvatom ponude Kupca čine ugovor.

II. PONUDE, NARUŽBA I CIJENE I SKLAPANJE UGOVORA

- 2.1. Ponuda Prodavatelja zasniva se na važećim cjenicima i katalogima proizvoda Prodavatelja. Kupac je isključivo odgovoran za ispravan odabir vrste proizvoda i njihove količine.
- 2.2. Ponuda Prodavatelja može biti prihvaćena samo pisanim putem.
- 2.3. Pisana i ovjerena narudžba Kupca smatra se temeljem za sklapanje ugovora o kupoprodaji.
- 2.4. Narudžba Kupca mora sadržavati:
 - * tvrtku, sjedište, OIB i odgovornu osobu Kupca
 - * specifikaciju naručene robe (tip, vrsta, količina i dimenzija), mjesto isporuke, težinu i način isporuke
 - * datum narudžbe,
 - * ime i prezime, funkciju osobe koja je ovlaštena preuzeti robu za Kupca
 - * u slučaju da se naručena roba, po nalogu Kupca, ima isporučiti trećoj osobi, takav nalog mora biti naznačen na narudžbi s točnom naznakom imena i adrese treće osobe, s time da se potpis i štambilj treće osobe na otpremnici Prodavatelja uzima kao potvrda da je roba isporučena Kupcu
- 2.5. Stranke će posebnim pogodbama ugovoriti rokove plaćanja, limite, vrijeme i način isporuke robe i druge međusobne obveze i prava pojedinog poslovnog odnosa.
- 2.6. Nakon što se stranke usuglase o posebnim pogodbama, ugovor o kupoprodaji se smatra sklopljenim u trenutku ovjere narudžbe od strane Prodavatelja

III. CIJENA I NAČIN PLAĆANJA

- 3.1. Kupac se obvezuje Prodavatelju naručenu robu platiti u ugovorenom roku i ugovorenoj prodajnoj cijeni. Prodajna cijena utvrđuje se prema cjeniku Prodavatelja (cijene su bez PDV-a) na dan narudžbe. Ukupna cijena narudžbe sa uključenim PDV-om biti će navedena prilikom ovjere narudžbe od strane Prodavatelja.
- 3.2. Na vrijednost robe koja se prodaje inozemnom kupcu (izvoz) ne obračunava se PDV.
- 3.3. **Limit dugovanja ugovorne strane ugovaraju posebnim pogodbama.**
- 3.4. U slučaju prekoračenja odobrenog limita ili prekoračenja ugovoreni rokova plaćanja Prodavatelj je ovlašten obustaviti daljnju isporuku robe, sve dok dugovanje Kupca ne padne ispod dozvoljenog limita, odnosno, dok Kupac ne plati dospjele račune, ili dok Kupac ne preda Prodavatelju odgovarajuće jamstvo.
- 3.5. Plaćanjem na vrijeme se smatra isključivo kada je uplata vidljiva na računu Prodavatelja ili ako se uplata na dan dospjeća izvrši gotovinom na blagajni Prodavatelja
- 3.6. Ukoliko Kupac ne plati ispostavljeni račun u roku, Prodavatelj ima pravo obračunati zakonsku zateznu kamatu

IV. ISPORUKA ROBE I ZADRŽAVANJE PRAVA VLASNIŠTVA

- 4.1. Prodavatelj je dužan Kupcu isporučiti robu u ugovorenom roku.
- 4.2. Prodavatelj je dužan Kupcu isporučiti robu kvalitete izrade prikladne za svrhu u koju će se roba koristiti.
- 4.3. Kupac je dužan naručenu i isporučenu robu preuzeti.
- 4.4. Prodavatelj je dužan robu zapakirati i organizirati prijevoz na način na koji je to za naručenu robu uobičajeno i predviđeno – osim ukoliko se stranke drugačije ne dogovore.
- 4.5. Isporučka robe se obavlja u vrijeme i na način koji je definiran posebnim pogodbama.
- 4.6. Ukoliko se roba preuzima u sjedištu Prodavatelja, osoba koja preuzima robu u ime i za račun Kupca dužna je skladišnom radniku Prodavatelja dokazati pravo na preuzimanje robe
- 4.7. Prilikom dostave na adresu Kupca Kupac je dužan ovjeriti otpremnicu kao znak da je roba doista preuzeta
- 4.8. Kupac je dužan ovjeriti čitljivim potpisom osobe preuzimatelja robe i štambiljem Kupca svaku otpremnicu kao znak da je roba doista isporučena i preuzeta
- 4.9. U slučaju da roba mora biti dostavljena na adresu Kupca, Prodavatelj će naplatiti dostavu po važećem cjeniku na dan narudžbe. Također, Prodavatelj zadržava pravo isporučiti robu na pristupačnom terenu.
- 4.10. Za robu koja se šalje poštom, Prodavatelj će Kupcu naplatiti troškove poštarine, osim ako nije drugačije dogovoreno.
- 4.11. Kupac se obavezuje preuzeti robu u ugovorenom roku, u suprotnom ulazi u zakašnjenje. U slučaju da Kupac ne ispuni svoju obavezu, Prodavatelj ga može pozvati na ispunjenje svoje obaveze u dodatnom roku. Ako Kupac ne podigne robu niti u dodatnom roku Prodavatelj je ovlašten raskinuti ugovor.
- 4.12. Prodavatelj zadržava sva vlasnička prava na robu koju isporučuje, sve dok Kupac u potpunosti ne plati ugovorenu cijenu.

V. OBUSTAVA ISPORUKE

- 5.1. Ukoliko Kupac ne ispuni jednu ili više svojih obveza ili to ne obavi ispravno i u skladu sa ugovorom primjenjuje se sljedeće:
 - * Obveze Prodavatelja se automatizmom i bez odgode obustavljaju sve dok Kupac ne podmiri svoja dugovanja (uključivo plaćanje sudskih i van sudskih troškova)
 - * Prodavatelj može zahtijevati potpunu isplatu i/ili odgovarajuće jamstvo Kupca (npr. bankarska garancija)
- 5.2. Prodavatelj ima pravo zatražiti od Kupca isplatu i/ili odgovarajuće jamstvo plaćanja ukoliko postoji opravdana sumnja da Kupac neće ili ne može ispuniti svoje obveze u ugovorenom roku

VI. RIZIK

- 6.1. Do predaje robe Kupcu rizik slučajne propasti ili oštećenja stvari snosi Prodavatelj, a s predajom stvari rizik prelazi na Kupca.
- 6.2. Ako je prodavatelj dužan poslati robu Kupcu, mora sklopiti na uobičajeni način i pod uobičajenim uvjetima ugovore potrebne za izvršenje prijevoza do određenog mjesta, s time da rizik od slučajne propasti ili oštećenja prelazi na Kupca u trenutku predaje robe poštanskoj službi.
- 6.3. Ako robu Kupac preuzima na skladištu Prodavatelja (osobno ili putem prijevoznika) rizik od slučajne propasti ili oštećenja prelazi na Kupca u trenutku predaje robe bilo Kupcu bilo prijevozniku.
- 6.4. Kupac je dužan bez odgode primljenu robu na uobičajeni način pregledati ili je dati na pregled.

VII. ODGOVORNOST ZA NEDOSTATKE I JAMSTVO

- 7.1. Prodavatelj odgovara za materijalne nedostatke robe koje je ona imala u trenutku prijelaza rizika na kupca, bez obzira je li mu to bilo poznato.
- 7.2. Prodavatelj odgovara i za one materijalne nedostatke koji se pojave nakon prijelaza rizika na Kupca, ukoliko Kupac može dokazati da su nedostaci posljedica uzroka koji je postojao prije prijelaza rizika
- 7.3. Kupac je dužan obavijestiti Prodavatelja o vidljivim nedostacima na primljenoj robu bez odgađanja.
- 7.4. Kad se nakon primitka robe od strane Kupca pokaže da roba ima neki nedostatak koji se nije mogao otkriti uobičajenim pregledom prilikom preuzimanja stvari, Kupac je dužan, pod prijetnjom gubitka prava, o tom nedostaku obavijestiti Prodavatelja bez odgađanja
- 7.5. Nedostaci se moraju opisati na način da ih Prodavatelj može provjeriti. Zbog toga Kupac mora voditi evidenciju o korištenju robe, a u slučaju preprodaje robe, isto je dužan zatražiti od svojih kupaca.
- 7.6. Kupac je dužan ograničiti na najmanju moguću mjeru štete na isporučenoj robi, za koju podnosi reklamaciju Prodavatelju.
- 7.7. Prodavatelj ne odgovara za nedostatke koji se pokažu pošto protekne jedan mjesec od primitka robe
- 7.8. Ako Prodavatelj jamči za ispravnost stvari u tijeku određenog vremena (jamstvo), postupak reklamacije biti će definiran posebnim jamstvenim listom
- 7.9. Jamstveni rok teče do dana preuzimanja robe. Ako Prodavatelj dostavlja robu Kupcu, jamstveni rok počinje teći od datuma kada je roba dostavljena na odredište. Jamstveni rok se produljuje za razdoblje u kojem Kupac ne može koristiti robu zbog nedostataka za koje odgovara Prodavatelj.
- 7.10. Ako Prodavatelj jamči za ispravnost robe u tijeku određenog vremena, računajući od njezine predaje Kupcu, Kupac može, ako roba nije ispravna, zahtijevati od Prodavatelja da stvar popravi u razumnom roku ili, ako to ne učini, da mu umjesto nje preda ispravnu stvar.
- 7.11. Kupci koji su ostvarili određeni rabat na nabavnu cijenu robe, nemaju pravo na naknadu zbog izgubljene zarade uslijed nedostatka na primljenoj robi

VIII. VIŠA SILA

- 8.1. Viša sila podrazumijeva okolnosti u kojima je ispunjenje obveza nemoguće ili nerazmjerno otežano, a koje se ne mogu pripisati Prodavatelju. Takve okolnosti mogu uključivati štrajkove, požare, ekstremne klimatske uvjete, vladine mjere, kao i nedostatke u proizvodima isporučenicima Prodavatelju, te druge vanjske, izvanredne i nepredvidive okolnosti nastale poslije sklapanja ugovora.
- 8.2. Svaka ugovorna strana dužna je bez odgode obavijestiti drugu o nastupu okolnosti iz prethodnog članka.
- 8.3. Ukoliko okolnosti nastale djelovanjem više sile traju duže od 30 dana, obje strane imaju pravo raskinuti ugovor. U tom slučaju Prodavatelj ne odgovara za štetu Kupcu.

IX. ZAŠTITA OSOBNIH PODATAKA

- 9.1. Prodavatelj radi brže poslovne komunikacije s Kupcem može za obradu poslovne dokumentacije i poslovnih događanja koristiti računalnu obradu podataka. S tim u vezi Prodavatelj jamči Kupcu da će sve podatke koji su mu poslijeđeni u svrhu poslovanja koristiti isključivo u opsegu potrebnom za obradu podataka.
- 9.2. Kupac daje Prodavatelju suglasnost za upotrebu podataka Kupca u svrhu:
 - a/ ostvarivanja prava i obveza koja proizlaze i kupoprodajnog odnosa
 - b/ vođenja evidencije obveza Kupca prema Prodavatelju
 - c/ provođenja marketinških aktivnosti

X. RJEŠAVANJE SPOROVA

- 10.1. Sve sporove koji bi proizašli iz ovih Uvjeta ili u vezi s njima, odnosno iz ugovora između Prodavatelja i Kupca ili u vezi s njima, uključujući i sporove koji se odnose na pitanja njihova valjana nastanka, povrede ili prestanka, kao i na pravne učinke koji iz toga proistječu, stranke će pokušati riješiti mirnim putem, no, ukoliko to ne bude moguće za rješavanje nastalih sporova biti će nadležan stvarno nadležni sud u Varaždinu.

XI. SALVATORSTA KLAUZULA

- 11.1. Ako bilo koja od odredbi ovih Općih uvjeta postane ništeta, ta će se odredba zamijeniti valjanom odredbom, koja u što većoj mjeri odgovara sadržaju i trgovačkom cilju koji su ugovorne strane htjele postići ranijom odredbom koja je proglašena ništetnom. Ukoliko ima više ništetnih odredbi, ova klauzula se primjenjuje na svaku ništetnu odredbu.
- 11.2. U tom slučaju ostale odredbe Općih uvjeta ostaju na snazi.

XII. ZAVRŠNE ODREDBE

- 12.1. Kupac nema pravo prenijeti svoja prava definirana ugovorom o kupoprodaji trećoj strani bez pismenog pristanka Prodavatelja
- 12.2. Uvjeti kupoprodaje koji se utvrđuju posebnim pogodbama moguće je mijenjati isključivo pismenim pute, zaključenjem Anexa ugovoru, koji je potpisani ovjeren od obje ugovornih strana
- 12.3. Kupac potvrđuje da je upoznat s ovim Općim uvjetima, da je pročitao Opće uvjete, da pristaje na njihovu primjenu, te da prihvaća sva prava i obveze koje proistječu iz ovih uvjeta