



ŽLEBNI SISTEM POLKROŽNI



CENIK

2024

PRIPOROČENA PRODAJNA CENA



POWERFUL PARTNER FOR YOUR ROOF



Aluminij material | 5



Žleb | 7

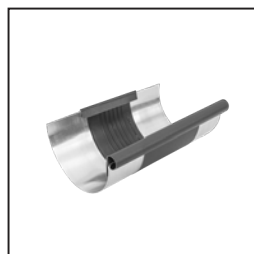

Strešni
diletacijski žleb | 9



Žleb
oprema | 12



Kljuka | 14



Vogalnik | 17



Zaključek
žleba | 19



Kotliček | 20



Koleno | 30

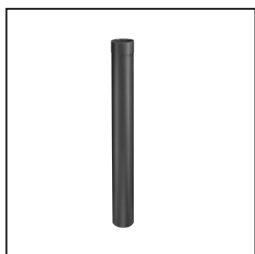

Cev odvodna | 33



Cev odvodna
oprema | 35



Objemka | 37

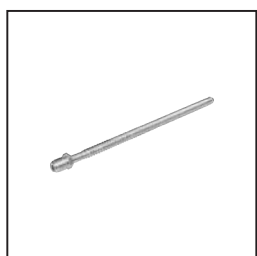

Objemka
oprema | 38



Lovilec
vode | 41



Zaščitna
cev | 43

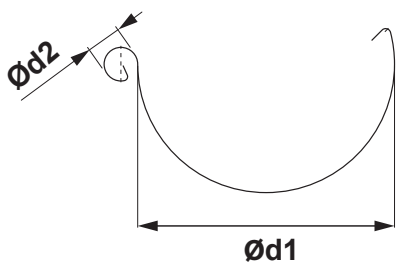

DIMENZIJE STREŠNIH ŽLEBOV

(dimenzije in toleranca po EN 612)

Razvita širina (mm)	250	280	333
Ød1	105	127	153
Ød2	18	18	20

NOTRANJI ZGIB

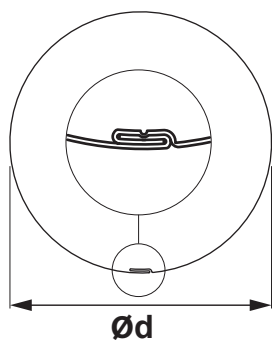

DIMENZIJE STREŠNIH ODOČNIH CEVI

(dimenzije in toleranca po EN 612)

Dimenzije	80	100	120
Imenska velikost Ød (mm)	80	100	120

DIMENZIJE STREŠNIH KAVLJEV

(dimenzije in toleranca po EN 612)

Dimenzije (mm)	L1	Ød
250	310	105
280	337	127
333 – 550	385	153

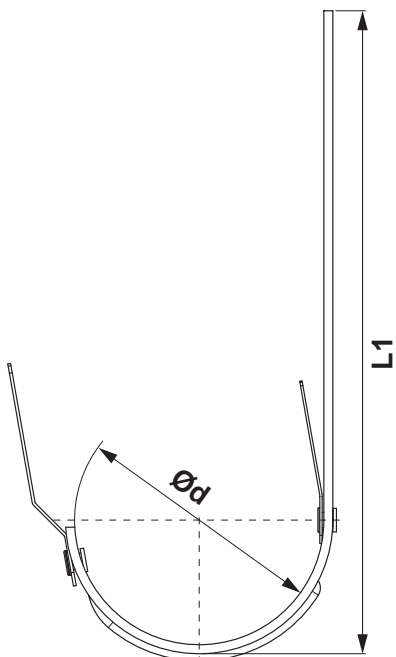

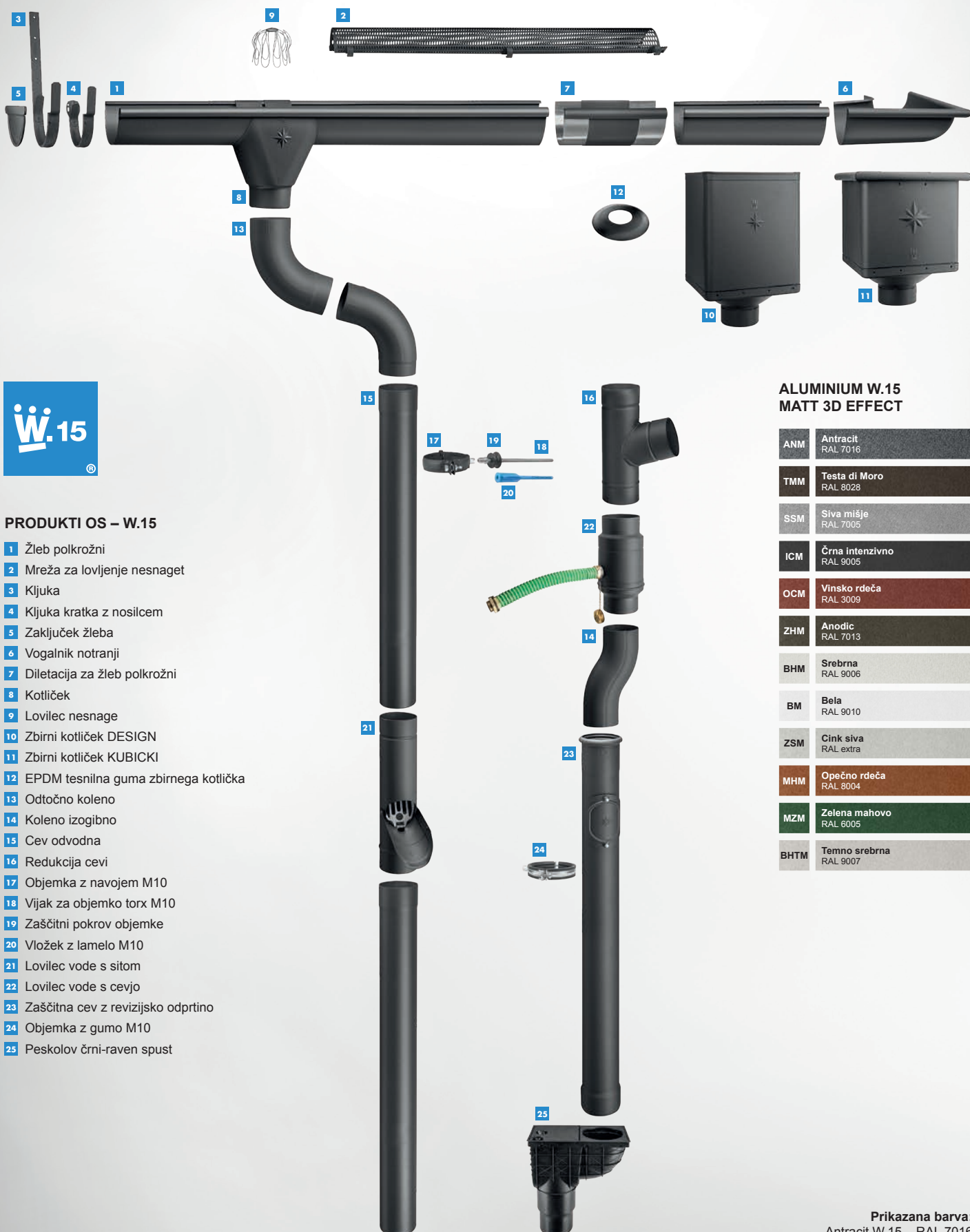

PRODUKTI OS – W.15

- 1 Žleb polkrožni
- 2 Mreža za lovljenje nesnaget
- 3 Kljuka
- 4 Kljuka kratka z nosilcem
- 5 Zaključek žleba
- 6 Vogalnik notranji
- 7 Diletacija za žleb polkrožni
- 8 Kotliček
- 9 Lovilec nesnage
- 10 Zbirni kotliček DESIGN
- 11 Zbirni kotliček KUBICKI
- 12 EPDM tesnilna guma zbirnega kotlička
- 13 Odbojno koleno
- 14 Koleno izogibno
- 15 Cev odvodna
- 16 Redukcija cevi
- 17 Objemka z navojem M10
- 18 Vijak za objemko torx M10
- 19 Zaščitni pokrov objemke
- 20 Vložek z lamelo M10
- 21 Lovilec vode s sitom
- 22 Lovilec vode s cevjo
- 23 Zaščitna cev z revizijsko odprtino
- 24 Objemka z gumo M10
- 25 Peskolov črni-raven spust

ALUMINIUM W.15 MATT 3D EFFECT

ANM	Antracit RAL 7016
TMM	Testa di Moro RAL 8028
SSM	Siva mišje RAL 7005
ICM	Črna intenzivno RAL 9005
OCM	Vinsko rdeča RAL 3009
ZHM	Anodic RAL 7013
BHM	Srebrna RAL 9006
BM	Bela RAL 9010
ZSM	Cink siva RAL extra
MHM	Opečno rdeča RAL 8004
MZM	Zelena mahovo RAL 6005
BHTM	Temno srebrna RAL 9007





ALUMINIUM W.15 MATT 3D EFFECT

SPEIRA

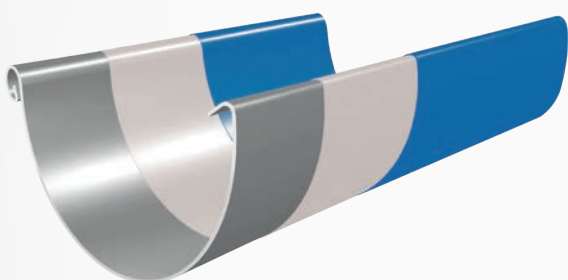
Speira je globalna družba za valjanje in predelavo aluminija. Sestavljena je iz raziskovalno-razvojnega centra in sedmih proizvodnih obratov. Obrati se nahajajo v Nemčiji in na Norveškem. Tam deluje tudi našo skupno podjetje Alunorf, ki je največja valjarna aluminija na svetu, in podjetje Grevenbroich, ki je največja valjarna za finalizacijo alumijskih izdelkov na svetu ter nekaj mednarodnih komercialnih pisarn. Speira zaposluje okoli 5 000 delavcev, zlasti v Nemčiji in na Norveškem.



-  Zgornji sloj je lak (cca 20 μm) na poliuretanski osnovi za odličen izgled in izvrstno odpornost na praske in 3D MATT efekt
-  Primer (cca 5 μm) za odlično prileganje in močno zaščito proti koroziji
-  Aluminij pločevina optimizirana za proizvodnjo odvodnega sistema OS – W.15

KJG

SPACE

®

ALUMINIJSKI MATERIAL Z ELEGANTNO MAT POVRŠINO



W.15

✦ Kakovostna barva
z lotos učinkom

✦ Visoka odpornost
proti praskam

✦ Visoka barvna
konsistenca



✦ W.15 – dvanajst
barvnih izvedb

✦ 40 let garancija
na material in barvo



ŽLEB POLKROŽNI [s=0,70]

W.15-WZ

Nominalna velikost	250		280		333		333		
Dolžina v m	4,0		4,0		4,0		6,0		
Cena v €/m	Brez DDV	Z DDV	Brez DDV	Z DDV	Brez DDV	Z DDV	Brez DDV	Z DDV	
ANM Antracit RAL 7016	1	6,15	7,50	7,75	9,46	7,80	9,52	7,80	9,52
		094001		094018		094025		094032	
TMM Testa di Moro RAL 8028	2	6,15	7,50	7,75	9,46	7,80	9,52	7,80	9,52
		100030		100047 *		100054		100061	
SSM Siva mišje RAL 7005	3	6,15	7,50	7,75	9,46	7,80	9,52	7,80	9,52
		099990		100009		100016		100023	
ICM Črna intenzivno RAL 9005	4	6,15	7,50	7,75	9,46	7,80	9,52	7,80	9,52
		114662		114679		114686		114693	
OCM Vinsko rdeča RAL 3009	5	6,15	7,50	7,75	9,46	7,80	9,52	7,80	9,52
		114709		114716 *		114723 *		114730	
ZHM Anodic RAL 7013	6	6,15	7,50	7,75	9,46	7,80	9,52	7,80	9,52
		111982		111999		112002		112019	
BHM Srebrna RAL 9006	7	6,15	7,50	7,75	9,46	7,80	9,52	7,80	9,52
		114624		114631 *		114648		114655	
BM Bela RAL 9010	8	6,15	7,50	7,75	9,46	7,80	9,52	7,80	9,52
		132833 *		132888 *		132932		132949	
ZSM Cink siva RAL extra	9	6,15	7,50	7,75	9,46	7,80	9,52	7,80	9,52
		132796 *		132840 *		132895 *		132987 *	
MHM Opečno rdeča RAL 8004	10	6,15	7,50	7,75	9,46	7,80	9,52	7,80	9,52
		132819 *		132864 *		132918 *		132963 *	
MZM Zelena mahovo RAL 6005	11	6,15	7,50	7,75	9,46	7,80	9,52	7,80	9,52
		132802 *		132857 *		132901 *		132970 *	
BHTM Temno srebrna RAL 9007	12	6,15	7,50	7,75	9,46	7,80	9,52	7,80	9,52
		132826 *		132871 *		132925 *		132956 *	
Pakiranje v m 		20		20		20		30	
Pakiranje v m 		960		840		660		990	

* Izdelava po meri





ALUMINIUM W.15

MATT 3D EFFECT

ŽLEB LEŽEČI [s=0,70]

W.15-WZS



Nominalna velikost	650	
Dolžina v m	6,0	
Cena v €/m	Brez DDV	Z DDV
ANM 1 Antracit RAL 7016	20,10	24,52
		094179
TMM 2 Testa di Moro RAL 8028	20,10	24,52
		100214 *
SSM 3 Siva mišje RAL 7005	20,10	24,52
		100221 *
ICM 4 Črna intenzivno RAL 9005	20,10	24,52
		114471 *
OCM 5 Vinsko rdeča RAL 3009	20,10	24,52
		114488 *
ZHM 6 Anodic RAL 7013	20,10	24,52
		112125 *
BHM 7 Srebrna RAL 9006	20,10	24,52
		114495 *
BM 8 Bela RAL 9010	20,10	24,52
		137500 *
ZSM 9 Cink siva RAL extra	20,10	24,52
		137531 *
MHM 10 Opečno rdeča RAL 8004	20,10	24,52
		137517 *
MZM 11 Zelena mahovo RAL 6005	20,10	24,52
		137524 *
BHTM 12 Temno srebrna RAL 9007	20,10	24,52
		137494 *
Pakiranje v m 	6	
Pakiranje v m 	300	

* Izdelava po meri



DILETACIJA ZA ŽLEB POLKROŽNI

W.15-WZDI

Nominalna velikost	250/260		285/260		333/260	
	Brez DDV	Z DDV	Brez DDV	Z DDV	Brez DDV	Z DDV
ANM 1 Antracit RAL 7016	21,30	25,99	22,35	27,27	22,35	27,27
	093356 *		093363 *		093370	
TMM 2 Testa di Moro RAL 8028	21,30	25,99	22,35	27,27	22,35	27,27
	098702 *		098719 *		098726	
SSM 3 Siva mišje RAL 7005	21,30	25,99	22,35	27,27	22,35	27,27
	098818 *		098825 *		098832 *	
ICM 4 Črna intenzivno RAL 9005	21,30	25,99	22,35	27,27	22,35	27,27
	118738 *		118745 *		118752	
OCM 5 Vinsko rdeča RAL 3009	21,30	25,99	22,35	27,27	22,35	27,27
	118769 *		118776 *		118783 *	
ZHM 6 Anodic RAL 7013	21,30	25,99	22,35	27,27	22,35	27,27
	111401 *		111418 *		111432	
BHM 7 Srebrna RAL 9006	21,30	25,99	22,35	27,27	22,35	27,27
	118707 *		118714 *		118721 *	
BM 8 Bela RAL 9010	21,30	25,99	22,35	27,27	22,35	27,27
	137029 *		137036 *		137043 *	
ZSM 9 Cink siva RAL extra	21,30	25,99	22,35	27,27	22,35	27,27
	137111 *		137128 *		137135 *	
MHM 10 Opečno rdeča RAL 8004	21,30	25,99	22,35	27,27	22,35	27,27
	137050 *		137067 *		137074 *	
MZM 11 Zelena mahovo RAL 6005	21,30	25,99	22,35	27,27	22,35	27,27
	137081 *		137098 *		137104 *	
BHTM 12 Temno srebrna RAL 9007	21,30	25,99	22,35	27,27	22,35	27,27
	136992 *		137005 *		137012 *	
Pakiranje v kos 	3		3		5	
Pakiranje v kos 	360		360		200	

* Izdelava po meri

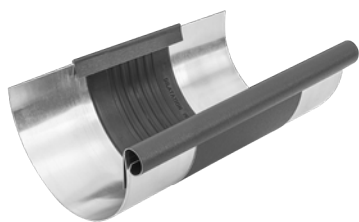



ALUMINIUM W.15

MATT 3D EFFECT

DILETACIJA ZA LEŽEČI ŽLEB

W.15-WZSDI

Nominalna velikost	670/260	
Cena v €/kos	Brez DDV	Z DDV
ANM 1 Antracit RAL 7016	67,60	82,47
	093400 *	
TMM 2 Testa di Moro RAL 8028	67,60	82,47
	098757 *	
SSM 3 Siva mišje RAL 7005	67,60	82,47
	098863 *	
ICM 4 Črna intenzivno RAL 9005	67,60	82,47
	118806 *	
OCM 5 Vinsko rdeča RAL 3009	67,60	82,47
	118813 *	
ZHM 6 Anodic RAL 7013	67,60	82,47
	111425 *	
BHM 7 Srebrna RAL 9006	67,60	82,47
	118790 *	
BM 8 Bela RAL 9010	67,60	82,47
	137555 *	
ZSM 9 Cink siva RAL extra	67,60	82,47
	137586 *	
MHM 10 Opečno rdeča RAL 8004	67,60	82,47
	137562 *	
MZM 11 Zelena mahovo RAL 6005	67,60	82,47
	137579 *	
BHTM 12 Temno srebrna RAL 9007	67,60	82,47
	137548 *	
Pakiranje v kos 	1	
Pakiranje v kos 	40	

* Izdelava po meri



ALUMINIUM
W.15

UPORABA DILATACIJSKEGA ŽLEBA IN DILATACIJSKEGA TRAKU

DILATACIJSKI ŽLEB

Primer montaže: Razvite širine do 500 mm. Dilatacijski žleb mora biti nameščen z razmikom 15 m. Za zunanji vogal in začetek žleba velja polovica standardne vrednosti: največ 7,5 m. Za notranji vogal velja četrtina standardne vrednosti: največ 3,75 m. Za druge materiale in dimenzije: glej tabelo spodaj. Vogali vedno štejejo kot fiksne točke.

DILATACIJSKI TRAK

Notranja namestitvev: na žlebove pritrjen brez lepljenja na podlago, strehe z nestandardnim profilom in pločevinsko obrobo zidov

STREŠNI POLOGLATI DILATACIJSKI ŽLEBOVI

Razvita širina žleba	Aluminij	Pocinkano, Cinkotit, Baker, Inox
< 500	12	15
> 500	8	10

STREŠNI DILATACIJSKI TRAK

Razvita širina žleba	Aluminij	Pocinkano, Cinkotit, Baker, Inox
< 500	8	10
> 500	6	8

Za zunanji vogal ali začetek žleba velja polovica standardne vrednosti. Za notranji vogal velja ena četrtina standardne vrednosti.

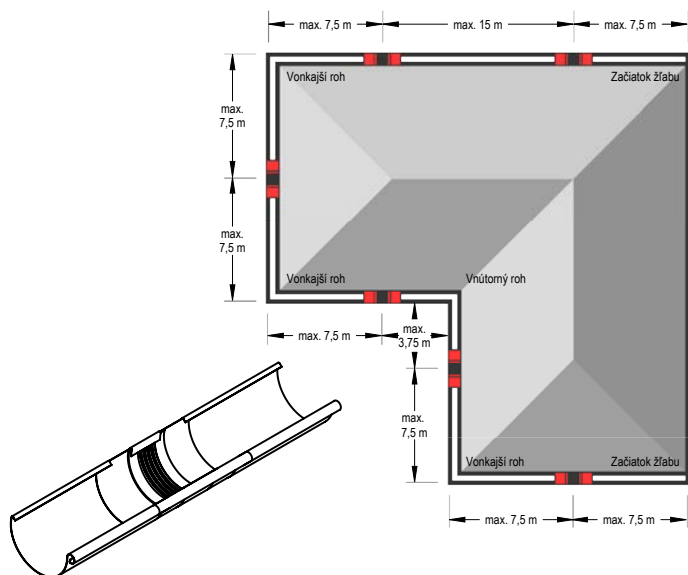

Opomba za montažo dilatacijskega žleba

Pri montaži s spajkanjem najprej srednji gumijasti del pokrijte z mokro krpo (da ne pride do prehoda toplotev srednji gumijasti del). Upoštevati je potrebno minimalno razdaljo 6 cm od srednjega gumijastega dela. V vsakem primeru se izogibajte kontaktu gume z odprtim ognjem.

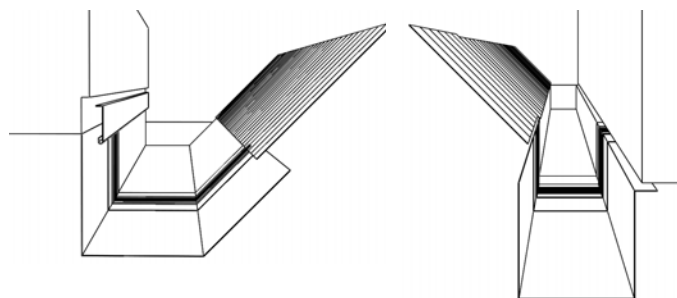

Opomba za montažo dilatacijskega traku

Pri krivljenju in montaži dilatacijskih elementov preverite, ali:



- je radij čeljusti za krivljenje vsaj 2 mm.
- Za debelino pločevine od 1 mm mora biti polmer krivljenja vsaj 5 mm.
- Čeljusti morajo biti za krivljenje nastavljene v debelini srednjega gumijastega dela 3 do 4 mm, da se prepreči učinek rezanja – poškodovanja gume.
- Gumijasti srednji del ne sme biti med krivljenjem stisnjen ali poškodovan. Zato je treba uporabiti aluminijški pločevinski trak 2 do 5 mm (debeline) ukrivljen tako, da se lahko pritrdi kot zaščita na čeljusti. Tako dosežete večji polmer krivljenja in preprečite poškodovanje gumijastega srednjega dela.

ALUMINIUM W.15

MATT 3D EFFECT

MREŽA ZA LOVLJENJE NESNAGE

W.15-WZNLM

Nominalna velikost	333	
Dolžina v m	2,0	
Cena v €/kos	Brez DDV	Z DDV
ANM 1 Antracit RAL 7016	27,00	32,94
	097149 *	
TMM 2 Testa di Moro RAL 8028	27,00	32,94
	118035 *	
SSM 3 Siva mišje RAL 7005	27,00	32,94
	118028 *	
ICM 4 Črna intenzivno RAL 9005	27,00	32,94
	118004 *	
OCM 5 Vinsko rdeča RAL 3009	27,00	32,94
	118011 *	
ZHM 6 Anodic RAL 7013	27,00	32,94
	118042 *	
BHM 7 Srebrna RAL 9006	27,00	32,94
	117991 *	
BM 8 Bela RAL 9010	27,00	32,94
	137142 *	
ZSM 9 Cink siva RAL extra	27,00	32,94
	137173 *	
MHM 10 Opečno rdeča RAL 8004	27,00	32,94
	137159 *	
MZM 11 Zelena mahovo RAL 6005	27,00	32,94
	137166 *	
BHTM 12 Temno srebrna RAL 9007	27,00	32,94
	137180 *	
Pakiranje v kos 	15	
Pakiranje v kos 	120	

* Izdelava po meri

ALUMINIUM
W.15

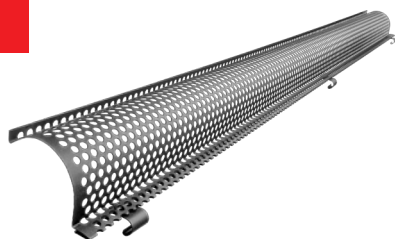



ALUMINIUM W.15

MATT 3D EFFECT



PVC MREŽA ZA LOVLJENJE LISTJA

SD-ZNL MREZKA

Nominalna velikost	Dolžina v m	EAN številko izdelka	Pakiranje v kos		Cena [€/kos]	
					Brez DDV	Z DDV
PS 171	1,0	008473	30	450	4,50	5,49
TM 171	1,0	008466	30	450	4,50	5,49

PVC MREŽA ZA LOVLJENJE LISTJA

SD-ZNL N

Nominalna velikost	Dolžina v m	EAN številko izdelka	Pakiranje v kos		Cena [€/kos]	
					Brez DDV	Z DDV
250	3,0	008480	10	400	23,90	29,16
280-333	3,0	008497	10	400	24,00	29,28





ALUMINIUM W.15

MATT 3D EFFECT

KLJUKA

W.15-WHP

Nominalna velikost	250/430		280/480		333/550		
Material	23/7		28/7		28/7		
Cena v €/kos	Brez DDV	Z DDV	Brez DDV	Z DDV	Brez DDV	Z DDV	
ANM Antracit RAL 7016	1	3,55	4,33	4,05	4,94	4,45	5,43
		093455		093462		093479	
TMM Testa di Moro RAL 8028	2	3,55	4,33	4,05	4,94	4,45	5,43
		098986		098993		099006	
SSM Siva mišje RAL 7005	3	3,55	4,33	4,05	4,94	4,45	5,43
		098955		098962		098979	
ICM Črna intenzivno RAL 9005	4	3,55	4,33	4,05	4,94	4,45	5,43
		116475		116482		116499	
OCM Vinsko rdeča RAL 3009	5	3,55	4,33	4,05	4,94	4,45	5,43
		116505		116512 *		116529	
ZHM Anodic RAL 7013	6	3,55	4,33	4,05	4,94	4,45	5,43
		111449		111456		111463	
BHM Srebrna RAL 9006	7	3,55	4,33	4,05	4,94	4,45	5,43
		116444 *		116451 *		116468	
BM Bela RAL 9010	8	3,55	4,33	4,05	4,94	4,45	5,43
		133083 *		133090 *		133106	
ZSM Cink siva RAL extra	9	3,55	4,33	4,05	4,94	4,45	5,43
		133175 *		133182 *		133199 *	
MHM Opečno rdeča RAL 8004	10	3,55	4,33	4,05	4,94	4,45	5,43
		133113		133120 *		133137	
MZM Zelena mahovo RAL 6005	11	3,55	4,33	4,05	4,94	4,45	5,43
		133144 *		133151 *		133168 *	
BHTM Temno srebrna RAL 9007	12	3,55	4,33	4,05	4,94	4,45	5,43
		133052 *		133069 *		133076 *	
Pakiranje v kos 		15		15		15	
Pakiranje v kos 		600		600		600	

* Izdelava po meri





ALUMINIUM W.15

MATT 3D EFFECT

KLJUKA KRATKA Z NOSILCEM

W.15-WHPK

Nominalna velikost	250		280		333	
Material	28/7		28/7		28/7	
Cena v €/kos	Brez DDV	Z DDV	Brez DDV	Z DDV	Brez DDV	Z DDV
ANM Antracit RAL 7016	4,00	4,88	4,05	4,94	4,10	5,00
	093486		093493		093509	
TMM Testa di Moro RAL 8028	4,00	4,88	4,05	4,94	4,10	5,00
	099020 *		099044 *		099068	
SSM Siva mišje RAL 7005	4,00	4,88	4,05	4,94	4,10	5,00
	099013 *		099037 *		099051	
ICM Črna intenzivno RAL 9005	4,00	4,88	4,05	4,94	4,10	5,00
	118448 *		118455 *		118462 *	
OCM Vinsko rdeča RAL 3009	4,00	4,88	4,05	4,94	4,10	5,00
	118479 *		118486 *		118493 *	
ZHM Anodic RAL 7013	4,00	4,88	4,05	4,94	4,10	5,00
	111470 *		111487 *		111494	
BHM Srebrna RAL 9006	4,00	4,88	4,05	4,94	4,10	5,00
	118417 *		118424 *		118431 *	
BM Bela RAL 9010	4,00	4,88	4,05	4,94	4,10	5,00
	133250 *		133267 *		133274 *	
ZSM Cink siva RAL extra	4,00	4,88	4,05	4,94	4,10	5,00
	133342 *		133359 *		133366 *	
MHM Opečno rdeča RAL 8004	4,00	4,88	4,05	4,94	4,10	5,00
	133281 *		133298 *		133304 *	
MZM Zelena mahovo RAL 6005	4,00	4,88	4,05	4,94	4,10	5,00
	133311 *		133328 *		133335 *	
BHTM Temno srebrna RAL 9007	4,00	4,88	4,05	4,94	4,10	5,00
	133229 *		133236 *		133243 *	
Pakiranje v kos 	15		15		15	
Pakiranje v kos 	600		600		600	

* Izdelava po meri





ALUMINIUM W.15

MATT 3D EFFECT

KLJUKA ZA LEŽEČI ŽLEB

W.15-WHSG

Nominalna velikost	4	
Material	28/7	
Cena v €/kos	Brez DDV	Z DDV
ANM 1 Antracit RAL 7016	9,30	11,35
		093516
TMM 2 Testa di Moro RAL 8028	9,30	11,35
		099082 *
SSM 3 Siva mišje RAL 7005	9,30	11,35
		099075 *
ICM 4 Črna intenzivno RAL 9005	9,30	11,35
		114600 *
OCM 5 Vinsko rdeča RAL 3009	9,30	11,35
		114617 *
ZHM 6 Anodic RAL 7013	9,30	11,35
		111500 *
BHM 7 Srebrna RAL 9006	9,30	11,35
		114594 *
BM 8 Bela RAL 9010	9,30	11,35
		135605 *
ZSM 9 Cink siva RAL extra	9,30	11,35
		135636 *
MHM 10 Opečno rdeča RAL 8004	9,30	11,35
		135612 *
MZM 11 Zelena mahovo RAL 6005	9,30	11,35
		135629 *
BHTM 12 Temno srebrna RAL 9007	9,30	11,35
		135599 *
Pakiranje v kos 	10	
Pakiranje v kos 	400	

* Izdelava po meri



ALUMINIUM
W.15

VOGALNIK NOTRANJI

W.15-WRA

Nominalna velikost	250		280		333	
	Brez DDV	Z DDV	Brez DDV	Z DDV	Brez DDV	Z DDV
ANM 1 Antracit RAL 7016	15,40	18,79	16,10	19,64	16,85	20,56
	093905		093912		093929	
TMM 2 Testa di Moro RAL 8028	15,40	18,79	16,10	19,64	16,85	20,56
	099822		099839 *		099846	
SSM 3 Siva mišje RAL 7005	15,40	18,79	16,10	19,64	16,85	20,56
	099792		099808		099815	
ICM 4 Črna intenzivno RAL 9005	15,40	18,79	16,10	19,64	16,85	20,56
	118868		118875		118882	
OCM 5 Vinsko rdeča RAL 3009	15,40	18,79	16,10	19,64	16,85	20,56
	118899 *		118905 *		118912 *	
ZHM 6 Anodic RAL 7013	15,40	18,79	16,10	19,64	16,85	20,56
	111876		111883 *		111890	
BHM 7 Srebrna RAL 9006	15,40	18,79	16,10	19,64	16,85	20,56
	118837 *		118844 *		118851 *	
BM 8 Bela RAL 9010	15,40	18,79	16,10	19,64	16,85	20,56
	136725 *		136732 *		136749	
ZSM 9 Cink siva RAL extra	15,40	18,79	16,10	19,64	16,85	20,56
	136817 *		136824 *		136831 *	
MHM 10 Opečno rdeča RAL 8004	15,40	18,79	16,10	19,64	16,85	20,56
	136756		136763 *		136770	
MZM 11 Zelena mahovo RAL 6005	15,40	18,79	16,10	19,64	16,85	20,56
	136787 *		136794 *		136800 *	
BHTM 12 Temno srebrna RAL 9007	15,40	18,79	16,10	19,64	16,85	20,56
	136695 *		136701 *		136718 *	
Pakiranje v kos 	5		5		5	
Pakiranje v kos 	150		150		150	

* Izdelava po meri

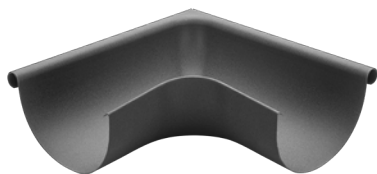

ALUMINIUM W.15

MATT 3D EFFECT

VOGALNIK ZUNANJI

W.15-WRI



Nominalna velikost	250		280		333	
	Brez DDV	Z DDV	Brez DDV	Z DDV	Brez DDV	Z DDV
ANM 1 Antracit RAL 7016	15,40	18,79	16,10	19,64	16,85	20,56
	093950		093967		093974	
TMM 2 Testa di Moro RAL 8028	15,40	18,79	16,10	19,64	16,85	20,56
	099884 *		099891 *		099907	
SSM 3 Siva mišje RAL 7005	15,40	18,79	16,10	19,64	16,85	20,56
	099853		099860		099877	
ICM 4 Črna intenzivno RAL 9005	15,40	18,79	16,10	19,64	16,85	20,56
	118950 *		118967 *		118974	
OCM 5 Vinsko rdeča RAL 3009	15,40	18,79	16,10	19,64	16,85	20,56
	118981 *		118998 *		119001 *	
ZHM 6 Anodic RAL 7013	15,40	18,79	16,10	19,64	16,85	20,56
	111906 *		111913 *		111920	
BHM 7 Srebrna RAL 9006	15,40	18,79	16,10	19,64	16,85	20,56
	118929 *		118936 *		118943 *	
BM 8 Bela RAL 9010	15,40	18,79	16,10	19,64	16,85	20,56
	136879 *		136886 *		136893	
ZSM 9 Cink siva RAL extra	15,40	18,79	16,10	19,64	16,85	20,56
	136961 *		136978 *		136985 *	
MHM 10 Opečno rdeča RAL 8004	15,40	18,79	16,10	19,64	16,85	20,56
	136909 *		136916 *		136923	
MZM 11 Zelena mahovo RAL 6005	15,40	18,79	16,10	19,64	16,85	20,56
	136930 *		136947 *		136954 *	
BHTM 12 Temno srebrna RAL 9007	15,40	18,79	16,10	19,64	16,85	20,56
	136848 *		136855 *		136862 *	
Pakiranje v kos 	5		5		5	
Pakiranje v kos 	150		150		150	

* Izdelava po meri



ZAKLJUČEK ŽLEBA

W.15-WCL

Nominalna velikost	250		280		333	
	Brez DDV	Z DDV	Brez DDV	Z DDV	Brez DDV	Z DDV
ANM 1 Antracit RAL 7016	1,55	1,89	1,60	1,95	1,65	2,01
	093301		093318		093325	
TMM 2 Testa di Moro RAL 8028	1,55	1,89	1,60	1,95	1,65	2,01
	098658 *		098665 *		098672	
SSM 3 Siva mišje RAL 7005	1,55	1,89	1,60	1,95	1,65	2,01
	098764		098771		098788	
ICM 4 Črna intenzivno RAL 9005	1,55	1,89	1,60	1,95	1,65	2,01
	118356		118363		118370	
OCM 5 Vinsko rdeča RAL 3009	1,55	1,89	1,60	1,95	1,65	2,01
	118387 *		118394 *		118400	
ZHM 6 Anodic RAL 7013	1,55	1,89	1,60	1,95	1,65	2,01
	111371 *		111388 *		111395	
BHM 7 Srebrna RAL 9006	1,55	1,89	1,60	1,95	1,65	2,01
	118325 *		118332 *		118349	
BM 8 Bela RAL 9010	1,55	1,89	1,60	1,95	1,65	2,01
	135476 *		135483 *		135490	
ZSM 9 Cink siva RAL extra	1,55	1,89	1,60	1,95	1,65	2,01
	135568 *		135575 *		135582 *	
MHM 10 Opečno rdeča RAL 8004	1,55	1,89	1,60	1,95	1,65	2,01
	135506		135513 *		135520	
MZM 11 Zelena mahovo RAL 6005	1,55	1,89	1,60	1,95	1,65	2,01
	135537 *		135544 *		135551 *	
BHTM 12 Temno srebrna RAL 9007	1,55	1,89	1,60	1,95	1,65	2,01
	135445 *		135452 *		135469 *	
Pakiranje v kos 	6/60		6/60		6/60	
Pakiranje v kos 	1 440		1 440		1 440	

* Izdelava po meri





ALUMINIUM W.15

MATT 3D EFFECT

KOTLIČEK

W.15-WKL



Nominalna velikost	250/80		280/80		280/100	
	Brez DDV	Z DDV	Brez DDV	Z DDV	Brez DDV	Z DDV
ANM 1 Antracit RAL 7016	11,75	14,34	13,50	16,47	13,00	15,86
	093585		093592 *		093608	
TMM 2 Testa di Moro RAL 8028	11,75	14,34	13,50	16,47	13,00	15,86
	099273		099280 *		099297	
SSM 3 Siva mišje RAL 7005	11,75	14,34	13,50	16,47	13,00	15,86
	099211		099228 *		099235	
ICM 4 Črna intenzivno RAL 9005	11,75	14,34	13,50	16,47	13,00	15,86
	116864		116871 *		116888	
OCM 5 Vinsko rdeča RAL 3009	11,75	14,34	13,50	16,47	13,00	15,86
	116925 *		116932 *		116949 *	
ZHM 6 Anodic RAL 7013	11,75	14,34	13,50	16,47	13,00	15,86
	111579		111586 *		111593	
BHM 7 Srebrna RAL 9006	11,75	14,34	13,50	16,47	13,00	15,86
	116802 *		116819 *		116826 *	
BM 8 Bela RAL 9010	11,75	14,34	13,50	16,47	13,00	15,86
	135858 *		135865 *		135872 *	
ZSM 9 Cink siva RAL extra	11,75	14,34	13,50	16,47	13,00	15,86
	136039 *		136046 *		136053 *	
MHM 10 Opečno rdeča RAL 8004	11,75	14,34	13,50	16,47	13,00	15,86
	135919		135926 *		135933 *	
MZM 11 Zelena mahovo RAL 6005	11,75	14,34	13,50	16,47	13,00	15,86
	135971 *		135988 *		135995 *	
BHTM 12 Temno srebrna RAL 9007	11,75	14,34	13,50	16,47	13,00	15,86
	135797 *		135803 *		135810 *	
Pakiranje v kos 	15		15		15	
Pakiranje v kos 	300		450		450	

* Izdelava po meri

KOTLIČEK

W.15-WKL

Nominalna velikost	333/80		333/100		333/120	
	Brez DDV	Z DDV	Brez DDV	Z DDV	Brez DDV	Z DDV
ANM 1 Antracit RAL 7016	13,95	17,02	14,25	17,39	18,70	22,81
	093615 *		093622		093639	
TMM 2 Testa di Moro RAL 8028	13,95	17,02	14,25	17,39	18,70	22,81
	099303 *		099310		099327	
SSM 3 Siva mišje RAL 7005	13,95	17,02	14,25	17,39	18,70	22,81
	099242 *		099259		099266	
ICM 4 Črna intenzivno RAL 9005	13,95	17,02	14,25	17,39	18,70	22,81
	116895 *		116901		116918 *	
OCM 5 Vinsko rdeča RAL 3009	13,95	17,02	14,25	17,39	18,70	22,81
	116956 *		116963 *		116970 *	
ZHM 6 Anodic RAL 7013	13,95	17,02	14,25	17,39	18,70	22,81
	111609 *		111616		111623	
BHM 7 Srebrna RAL 9006	13,95	17,02	14,25	17,39	18,70	22,81
	116833 *		116840 *		116857 *	
BM 8 Bela RAL 9010	13,95	17,02	14,25	17,39	18,70	22,81
	135889 *		135896		135902 *	
ZSM 9 Cink siva RAL extra	13,95	17,02	14,25	17,39	18,70	22,81
	136060 *		136077 *		136084 *	
MHM 10 Opečno rdeča RAL 8004	13,95	17,02	14,25	17,39	18,70	22,81
	135940		135957		135964	
MZM 11 Zelena mahovo RAL 6005	13,95	17,02	14,25	17,39	18,70	22,81
	136008 *		136015 *		136022 *	
BHTM 12 Temno srebrna RAL 9007	13,95	17,02	14,25	17,39	18,70	22,81
	135827 *		135834 *		135841 *	
Pakiranje v kos 	15		15		10	
Pakiranje v kos 	450		450		200	

* Izdelava po meri



ALUMINIUM W.15

MATT 3D EFFECT

NOV PRIČVRSTILNI
SISTEM FEDER OMOGOČA
LAHKO OBRAČANJE KOLENA
DO ŽELJENE SMERI IN OSTANE
FIKSIRANO V VSAKI POZICIJI.
ENOSTAVNA MONTAŽA NA
BILO KATERO KOLENO
BREZ KOVIČENJA.



1



2



3





ALUMINIUM W.15

MATT 3D EFFECT

INOX LOVILEC NESNAGE

N-NZN



Nominalna velikost	EAN številko izdelka	Pakiranje v kos		Cena [€/kos]	
				Brez DDV	Z DDV
60	001153	30	2 160	5,55	6,77
80	001160	20	1 440	5,60	6,83
100	001177	15	1 080	5,70	6,95
120	001184	10	720	6,20	7,56
150	001191	5	360	9,80	11,96



ALUMINIUM W.15

MATT 3D EFFECT

ZBIRNI KOTLIČEK DESIGN

W.15-WKLZ DE

Nominalna velikost	80		100		120	
	Brez DDV	Z DDV	Brez DDV	Z DDV	Brez DDV	Z DDV
ANM 1 Antracit RAL 7016	103,90	126,76	103,90	126,76	109,20	133,22
	093677 *		093721		093776 *	
TMM 2 Testa di Moro RAL 8028	103,90	126,76	103,90	126,76	109,20	133,22
	100634 *		100689 *		100733 *	
SSM 3 Siva mišje RAL 7005	103,90	126,76	103,90	126,76	109,20	133,22
	100481 *		100535 *		100580 *	
ICM 4 Črna intenzivno RAL 9005	103,90	126,76	103,90	126,76	109,20	133,22
	138606 *		138651 *		138705 *	
OCM 5 Vinsko rdeča RAL 3009	103,90	126,76	103,90	126,76	109,20	133,22
	139054 *		139108 *		139153 *	
ZHM 6 Anodic RAL 7013	103,90	126,76	103,90	126,76	109,20	133,22
	111647 *		111692 *		111746 *	
BHM 7 Srebrna RAL 9006	103,90	126,76	103,90	126,76	109,20	133,22
	138156 *		138200 *		138255 *	
BM 8 Bela RAL 9010	103,90	126,76	103,90	126,76	109,20	133,22
	138453 *		138507 *		138552 *	
ZSM 9 Cink siva RAL extra	103,90	126,76	103,90	126,76	109,20	133,22
	139207 *		139252 *		139306 *	
MHM 10 Opečno rdeča RAL 8004	103,90	126,76	103,90	126,76	109,20	133,22
	138750 *		138804 *		138859 *	
MZM 11 Zelena mahovo RAL 6005	103,90	126,76	103,90	126,76	109,20	133,22
	138903 *		138958 *		139009 *	
BHTM 12 Temno srebrna RAL 9007	103,90	126,76	103,90	126,76	109,20	133,22
	138309 *		138354 *		138408 *	
Pakiranje v kos 	2		2		2	
Pakiranje v kos 	36		36		36	

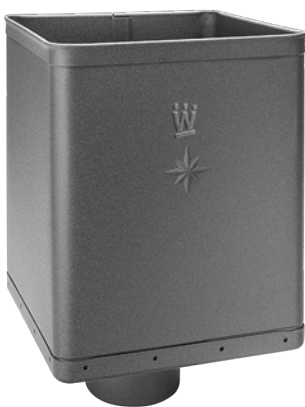

* Izdelava po meri



ZBIRNI KOTLIČEK DESIGN EKSCENTRIČE

W.15-WKLZ DX



Nominalna velikost	80		100		120	
	Brez DDV	Z DDV	Brez DDV	Z DDV	Brez DDV	Z DDV
ANM 1 Antracit RAL 7016	119,60	145,91	119,60	145,91	130,00	158,60
	093660 *		093714		093769 *	
TMM 2 Testa di Moro RAL 8028	119,60	145,91	119,60	145,91	130,00	158,60
	100627 *		100672 *		100726 *	
SSM 3 Siva mišje RAL 7005	119,60	145,91	119,60	145,91	130,00	158,60
	100474 *		100528 *		100573 *	
ICM 4 Črna intenzivno RAL 9005	119,60	145,91	119,60	145,91	130,00	158,60
	138613 *		138668 *		138712 *	
OCM 5 Vinsko rdeča RAL 3009	119,60	145,91	119,60	145,91	130,00	158,60
	139061 *		139115 *		139160 *	
ZHM 6 Anodic RAL 7013	119,60	145,91	119,60	145,91	130,00	158,60
	111630 *		111685 *		111739 *	
BHM 7 Srebrna RAL 9006	119,60	145,91	119,60	145,91	130,00	158,60
	138163 *		138217 *		138262 *	
BM 8 Bela RAL 9010	119,60	145,91	119,60	145,91	130,00	158,60
	138460 *		138514 *		138569 *	
ZSM 9 Cink siva RAL extra	119,60	145,91	119,60	145,91	130,00	158,60
	139214 *		139269 *		139313 *	
MHM 10 Opečno rdeča RAL 8004	119,60	145,91	119,60	145,91	130,00	158,60
	138767 *		138811 *		138866 *	
MZM 11 Zelena mahovo RAL 6005	119,60	145,91	119,60	145,91	130,00	158,60
	138910 *		138965 *		139016 *	
BHTM 12 Temno srebrna RAL 9007	119,60	145,91	119,60	145,91	130,00	158,60
	138316 *		138361 *		138415 *	
Pakiranje v kos 	2		2		2	
Pakiranje v kos 	36		36		36	

* Izdelava po meri

ALUMINIUM W.15

MATT 3D EFFECT

ZBIRNI KOTLIČEK KUBICKI

W.15-WKLZ KU

Nominalna velikost	80		100		120	
	Brez DDV	Z DDV	Brez DDV	Z DDV	Brez DDV	Z DDV
ANM 1 Antracit RAL 7016	133,10	162,38	133,10	162,38	150,80	183,98
	093684 *		093738 *		093783 *	
TMM 2 Testa di Moro RAL 8028	133,10	162,38	133,10	162,38	150,80	183,98
	100641 *		100696 *		100740 *	
SSM 3 Siva mišje RAL 7005	133,10	162,38	133,10	162,38	150,80	183,98
	100498 *		100542 *		100597 *	
ICM 4 Črna intenzivno RAL 9005	133,10	162,38	133,10	162,38	150,80	183,98
	138620 *		138675 *		138729 *	
OCM 5 Vinsko rdeča RAL 3009	133,10	162,38	133,10	162,38	150,80	183,98
	139078 *		139122 *		139177 *	
ZHM 6 Anodic RAL 7013	133,10	162,38	133,10	162,38	150,80	183,98
	111654 *		111708 *		111753 *	
BHM 7 Srebrna RAL 9006	133,10	162,38	133,10	162,38	150,80	183,98
	138170 *		138224 *		138279 *	
BM 8 Bela RAL 9010	133,10	162,38	133,10	162,38	150,80	183,98
	138477 *		138521 *		138576 *	
ZSM 9 Cink siva RAL extra	133,10	162,38	133,10	162,38	150,80	183,98
	139221 *		139276 *		139320 *	
MHM 10 Opečno rdeča RAL 8004	133,10	162,38	133,10	162,38	150,80	183,98
	138774 *		138828 *		138873 *	
MZM 11 Zelena mahovo RAL 6005	133,10	162,38	133,10	162,38	150,80	183,98
	138927 *		138972 *		139023 *	
BHTM 12 Temno srebrna RAL 9007	133,10	162,38	133,10	162,38	150,80	183,98
	138323 *		138378 *		138422 *	
Pakiranje v kos 	2		2		2	
Pakiranje v kos 	36		36		36	

* Izdelava po meri



ZBIRNI KOTLIČEK KUBICKI EKSCENTRIČEN

W.15-WKLZ KX



Nominalna velikost	80		100		120	
	Brez DDV	Z DDV	Brez DDV	Z DDV	Brez DDV	Z DDV
ANM 1 Antracit RAL 7016	140,40	171,29	140,40	171,29	150,80	183,98
	093707 *		093752		093806 *	
TMM 2 Testa di Moro RAL 8028	140,40	171,29	140,40	171,29	150,80	183,98
	100665 *		100719		100764 *	
SSM 3 Siva mišje RAL 7005	140,40	171,29	140,40	171,29	150,80	183,98
	100511 *		100566		100610 *	
ICM 4 Črna intenzivno RAL 9005	140,40	171,29	140,40	171,29	150,80	183,98
	138637 *		138682 *		138736 *	
OCM 5 Vinsko rdeča RAL 3009	140,40	171,29	140,40	171,29	150,80	183,98
	139085 *		139139 *		139184 *	
ZHM 6 Anodic RAL 7013	140,40	171,29	140,40	171,29	150,80	183,98
	111678 *		111722		111777 *	
BHM 7 Srebrna RAL 9006	140,40	171,29	140,40	171,29	150,80	183,98
	138187 *		138231 *		138286 *	
BM 8 Bela RAL 9010	140,40	171,29	140,40	171,29	150,80	183,98
	138484 *		138538 *		138583 *	
ZSM 9 Cink siva RAL extra	140,40	171,29	140,40	171,29	150,80	183,98
	139238 *		139283 *		139337 *	
MHM 10 Opečno rdeča RAL 8004	140,40	171,29	140,40	171,29	150,80	183,98
	138781 *		138835 *		138880 *	
MZM 11 Zelena mahovo RAL 6005	140,40	171,29	140,40	171,29	150,80	183,98
	138934 *		138989 *		139030 *	
BHTM 12 Temno srebrna RAL 9007	140,40	171,29	140,40	171,29	150,80	183,98
	138330 *		138385 *		138439 *	
Pakiranje v kos 	2		2		2	
Pakiranje v kos 	36		36		36	



* Izdelava po meri

ALUMINIUM W.15

MATT 3D EFFECT

ZBIRNI KOTLIČEK KUBICKI EKSCENTRIČEN ISPUSTOM W.15-WKLZ KXV











Nominalna velikost	80		100		120	
	Brez DDV	Z DDV	Brez DDV	Z DDV	Brez DDV	Z DDV
ANM 1 Antracit RAL 7016	166,40	203,01	166,40	203,01	176,80	215,70
	093691 *		093745 *		093790 *	
TMM 2 Testa di Moro RAL 8028	166,40	203,01	166,40	203,01	176,80	215,70
	100658 *		100702 *		100757 *	
SSM 3 Siva mišje RAL 7005	166,40	203,01	166,40	203,01	176,80	215,70
	100504 *		100559 *		100603 *	
ICM 4 Črna intenzivno RAL 9005	166,40	203,01	166,40	203,01	176,80	215,70
	138644 *		138699 *		138743 *	
OCM 5 Vinsko rdeča RAL 3009	166,40	203,01	166,40	203,01	176,80	215,70
	139092 *		139146 *		139191 *	
ZHM 6 Anodic RAL 7013	166,40	203,01	166,40	203,01	176,80	215,70
	111661 *		111715 *		111760 *	
BHM 7 Srebrna RAL 9006	166,40	203,01	166,40	203,01	176,80	215,70
	138194 *		138248 *		138293 *	
BM 8 Bela RAL 9010	166,40	203,01	166,40	203,01	176,80	215,70
	138491 *		138545 *		138590 *	
ZSM 9 Cink siva RAL extra	166,40	203,01	166,40	203,01	176,80	215,70
	139245 *		139290 *		139344 *	
MHM 10 Opečno rdeča RAL 8004	166,40	203,01	166,40	203,01	176,80	215,70
	138798 *		138842 *		138897 *	
MZM 11 Zelena mahovo RAL 6005	166,40	203,01	166,40	203,01	176,80	215,70
	138941 *		138996 *		139047 *	
BHTM 12 Temno srebrna RAL 9007	166,40	203,01	166,40	203,01	176,80	215,70
	138347 *		138392 *		138446 *	
Pakiranje v kos 	2		2		2	
Pakiranje v kos 	36		36		36	

* Izdelava po meri

TESNILNA GUMA ZBIRNEGA KOTLIČKA

P-PKLZ T



Nominalna velikost	EAN številko izdelka	Pakiranje v kos		Cena [€/kos]	
				Brez DDV	Z DDV
 70-85	077103	5	600	4,00	4,88
 100-110	077110	5	600	4,10	5,00
 110-125	077097	5	600	4,20	5,12
 70-85	077134	5	600	4,50	5,49
 100-110	077141	5	600	4,90	5,98
 110-125	077127	5	600	5,00	6,10

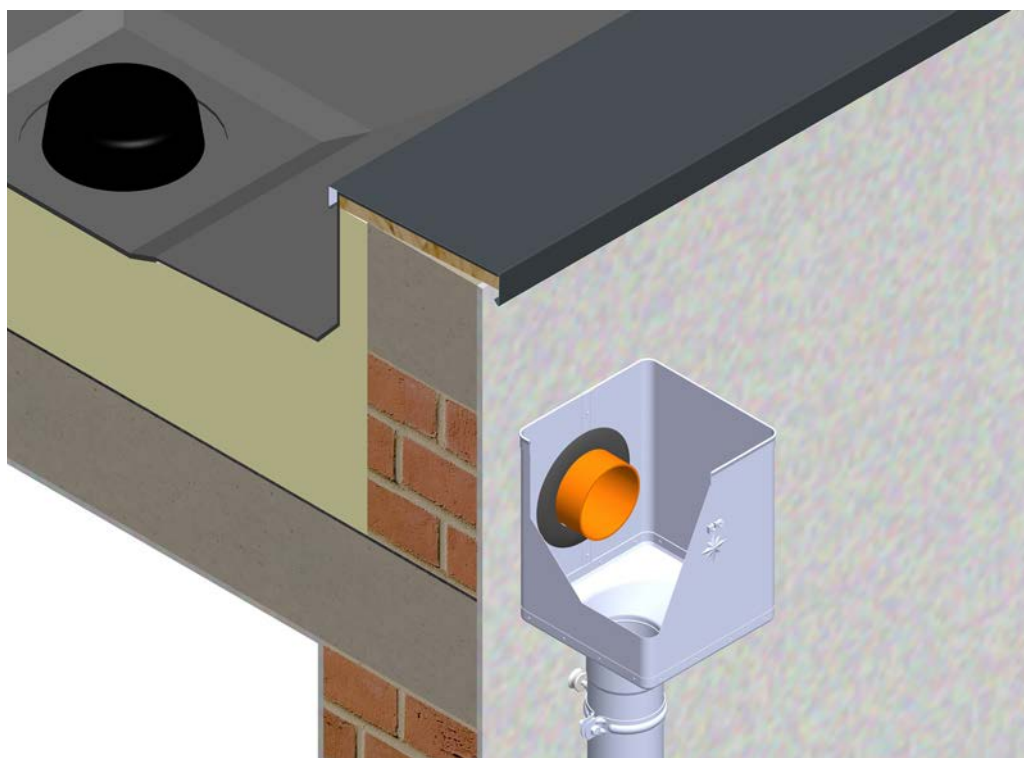

ODTOČNO KOLENO 72°

W.15-WK

Nominalna velikost	80		100		120	
	Brez DDV	Z DDV	Brez DDV	Z DDV	Brez DDV	Z DDV
ANM 1 Antracit RAL 7016	9,35	11,41	10,00	12,20	15,20	18,54
	093523		093547		093561	
TMM 2 Testa di Moro RAL 8028	9,35	11,41	10,00	12,20	15,20	18,54
	099129		099136		099143	
SSM 3 Siva mišje RAL 7005	9,35	11,41	10,00	12,20	15,20	18,54
	099099		099105		099112	
ICM 4 Črna intenzivno RAL 9005	9,35	11,41	10,00	12,20	15,20	18,54
	116567		116574		116581 *	
OCM 5 Vinsko rdeča RAL 3009	9,35	11,41	10,00	12,20	15,20	18,54
	116598 *		116604 *		116611 *	
ZHM 6 Anodic RAL 7013	9,35	11,41	10,00	12,20	15,20	18,54
	111517		111531		111555	
BHM 7 Srebrna RAL 9006	9,35	11,41	10,00	12,20	15,20	18,54
	116536 *		116543 *		116550 *	
BM 8 Bela RAL 9010	9,35	11,41	10,00	12,20	15,20	18,54
	135674 *		135681		135698 *	
ZSM 9 Cink siva RAL extra	9,35	11,41	10,00	12,20	15,20	18,54
	135766 *		135773 *		135780 *	
MHM 10 Opečno rdeča RAL 8004	9,35	11,41	10,00	12,20	15,20	18,54
	135704		135711		135728	
MZM 11 Zelena mahovo RAL 6005	9,35	11,41	10,00	12,20	15,20	18,54
	135735 *		135742 *		135759 *	
BHTM 12 Temno srebrna RAL 9007	9,35	11,41	10,00	12,20	15,20	18,54
	135643 *		135650 *		135667 *	
Pakiranje v kos 	4		4		2	
Pakiranje v kos 	240		120		120	

* Izdelava po meri



ALUMINIUM
W.15

ODTOČNO KOLENO 85°

W.15-WKR

Nominalna velikost	80		100		120	
	Brez DDV	Z DDV	Brez DDV	Z DDV	Brez DDV	Z DDV
ANM 1 Antracit RAL 7016	11,65	14,21	14,55	17,75	18,70	22,81
	093530 *		093554		093578 *	
TMM 2 Testa di Moro RAL 8028	11,65	14,21	14,55	17,75	18,70	22,81
	099167 *		099181		099204 *	
SSM 3 Siva mišje RAL 7005	11,65	14,21	14,55	17,75	18,70	22,81
	099150 *		099174		099198 *	
ICM 4 Črna intenzivno RAL 9005	11,65	14,21	14,55	17,75	18,70	22,81
	116628 *		116635 *		116642 *	
OCM 5 Vinsko rdeča RAL 3009	11,65	14,21	14,55	17,75	18,70	22,81
	116659 *		116666 *		116673 *	
ZHM 6 Anodic RAL 7013	11,65	14,21	14,55	17,75	18,70	22,81
	111524 *		111548		111562 *	
BHM 7 Srebrna RAL 9006	11,65	14,21	14,55	17,75	18,70	22,81
	116680 *		116697 *		116703 *	
BM 8 Bela RAL 9010	11,65	14,21	14,55	17,75	18,70	22,81
	136275 *		136282		136299 *	
ZSM 9 Cink siva RAL extra	11,65	14,21	14,55	17,75	18,70	22,81
	136367 *		136374 *		136381 *	
MHM 10 Opečno rdeča RAL 8004	11,65	14,21	14,55	17,75	18,70	22,81
	136305 *		136312 *		136329 *	
MZM 11 Zelena mahovo RAL 6005	11,65	14,21	14,55	17,75	18,70	22,81
	136336 *		136343 *		136350 *	
BHTM 12 Temno srebrna RAL 9007	11,65	14,21	14,55	17,75	18,70	22,81
	136224 *		136251 *		136268 *	
Pakiranje v kos 	4		4		4	
Pakiranje v kos 	240		120		120	

* Izdelava po meri



ODTOČNO KOLENO 40°

W.15-WKT

Nominalna velikost	80		100		120	
	Brez DDV	Z DDV	Brez DDV	Z DDV	Brez DDV	Z DDV
ANM 1 Antracit RAL 7016	9,25	11,29	11,45	13,97	15,50	18,91
	093844		093851		093868	
TMM 2 Testa di Moro RAL 8028	9,25	11,29	11,45	13,97	15,50	18,91
	099440		099464		099471 *	
SSM 3 Siva mišje RAL 7005	9,25	11,29	11,45	13,97	15,50	18,91
	099433		099457		099488 *	
ICM 4 Črna intenzivno RAL 9005	9,25	11,29	11,45	13,97	15,50	18,91
	116741 *		116758 *		116765 *	
OCM 5 Vinsko rdeča RAL 3009	9,25	11,29	11,45	13,97	15,50	18,91
	116772 *		116789 *		116796 *	
ZHM 6 Anodic RAL 7013	9,25	11,29	11,45	13,97	15,50	18,91
	111814		111821		111838 *	
BHM 7 Srebrna RAL 9006	9,25	11,29	11,45	13,97	15,50	18,91
	116710 *		116727 *		116734 *	
BM 8 Bela RAL 9010	9,25	11,29	11,45	13,97	15,50	18,91
	136428 *		136435		136442 *	
ZSM 9 Cink siva RAL extra	9,25	11,29	11,45	13,97	15,50	18,91
	136510 *		136527 *		136534 *	
MHM 10 Opečno rdeča RAL 8004	9,25	11,29	11,45	13,97	15,50	18,91
	136459 *		136466 *		136473 *	
MZM 11 Zelena mahovo RAL 6005	9,25	11,29	11,45	13,97	15,50	18,91
	136480 *		136497 *		136503 *	
BHTM 12 Temno srebrna RAL 9007	9,25	11,29	11,45	13,97	15,50	18,91
	136398 *		136404 *		136411 *	
Pakiranje v kos 	4		4		4	
Pakiranje v kos 	240		120		120	

* Izdelava po meri





ALUMINIUM W.15

MATT 3D EFFECT

CEV ODVODNA [s=0,70]

W.15-WZR

Nominalna velikost	80		100		100		120		
Dolžina v m	3,0		3,0		4,0		3,0		
Cena v €/m	Brez DDV	Z DDV	Brez DDV	Z DDV	Brez DDV	Z DDV	Brez DDV	Z DDV	
ANM Antracit RAL 7016	1	7,75	9,46	8,30	10,13	8,30	10,13	11,20	13,66
		094131		094148		094155		094162	
TMM Testa di Moro RAL 8028	2	7,75	9,46	8,30	10,13	8,30	10,13	11,20	13,66
		100177		100184		100191		100207	
SSM Siva mišje RAL 7005	3	7,75	9,46	8,30	10,13	8,30	10,13	11,20	13,66
		100139		100146		100153		100160	
ICM Črna intenzivno RAL 9005	4	7,75	9,46	8,30	10,13	8,30	10,13	11,20	13,66
		115294		115300		115317		115324	
OCM Vinsko rdeča RAL 3009	5	7,75	9,46	8,30	10,13	8,30	10,13	11,20	13,66
		115331		115348		115355		115362	
ZHM Anodic RAL 7013	6	7,75	9,46	8,30	10,13	8,30	10,13	11,20	13,66
		112088		112095		112101 *		112118	
BHM Srebrna RAL 9006	7	7,75	9,46	8,30	10,13	8,30	10,13	11,20	13,66
		115249		115256		115263		115287	
BM Bela RAL 9010	8	7,75	9,46	8,30	10,13	8,30	10,13	11,20	13,66
		132598		132604		132611		132628 *	
ZSM Cink siva RAL extra	9	7,75	9,46	8,30	10,13	8,30	10,13	11,20	13,66
		132680 *		132727 *		132734 *		132789 *	
MHM Opečno rdeča RAL 8004	10	7,75	9,46	8,30	10,13	8,30	10,13	11,20	13,66
		132673 *		132703 *		132758 *		132765 *	
MZM Zelena mahovo RAL 6005	11	7,75	9,46	8,30	10,13	8,30	10,13	11,20	13,66
		132697 *		132710 *		132741 *		132772 *	
BHTM Temno srebrna RAL 9007	12	7,75	9,46	8,30	10,13	8,30	10,13	11,20	13,66
		132635 *		132642 *		132659 *		132666 *	
Pakiranje v m 		18		18		24		18	
Pakiranje v m 		216		180		240		144	



* Izdelava po meri



PVC CEVNA FOLIJA

SD-ZR FOLIJA KJG



Nominalna velikost	Dolžina v m	EAN številko izdelka	Pakiranje v m		Cena [€/kos]	
					Brez DDV	Z DDV
60-150	100,0	139726	100	6 000	0,38	0,46

ALUMINIUM W.15

MATT 3D EFFECT

ODTOČNO KOLENO ODSKOKOVÉ

W.15-WKO

Nominalna velikost	80		100		120	
	Brez DDV	Z DDV	Brez DDV	Z DDV	Brez DDV	Z DDV
ANM 1 Antracit RAL 7016	11,45	13,97	14,00	17,08	16,60	20,25
	093813		093820		093837	
TMM 2 Testa di Moro RAL 8028	11,45	13,97	14,00	17,08	16,60	20,25
	099389 *		099402 *		099426 *	
SSM 3 Siva mišje RAL 7005	11,45	13,97	14,00	17,08	16,60	20,25
	099372		099396		099419 *	
ICM 4 Črna intenzivno RAL 9005	11,45	13,97	14,00	17,08	16,60	20,25
	118639 *		118646		118653 *	
OCM 5 Vinsko rdeča RAL 3009	11,45	13,97	14,00	17,08	16,60	20,25
	118660 *		118677 *		118684 *	
ZHM 6 Anodic RAL 7013	11,45	13,97	14,00	17,08	16,60	20,25
	111784 *		111791 *		111807 *	
BHM 7 Srebrna RAL 9006	11,45	13,97	14,00	17,08	16,60	20,25
	118608 *		118615 *		118622 *	
BM 8 Bela RAL 9010	11,45	13,97	14,00	17,08	16,60	20,25
	136213 *		136220		136237 *	
ZSM 9 Cink siva RAL extra	11,45	13,97	14,00	17,08	16,60	20,25
	136152 *		136169 *		136176 *	
MHM 10 Opečno rdeča RAL 8004	11,45	13,97	14,00	17,08	16,60	20,25
	136091 *		136107		136114 *	
MZM 11 Zelena mahovo RAL 6005	11,45	13,97	14,00	17,08	16,60	20,25
	136121 *		136138 *		136145 *	
BHTM 12 Temno srebrna RAL 9007	11,45	13,97	14,00	17,08	16,60	20,25
	136183 *		136190 *		136206 *	
Pakiranje v kos 	4		4		2	
Pakiranje v kos 	240		120		120	

* Izdelava po meri





ALUMINIUM
W.15

REDUKCIJA CEVI 72°

W.15-WZO



Nominalna velikost	80/80		100/80		100/100	
	Brez DDV	Z DDV	Brez DDV	Z DDV	Brez DDV	Z DDV
ANM 1 Antracit RAL 7016	40,00	48,80	41,10	50,14	41,50	50,63
	094070 *		094087 *		094094	
TMM 2 Testa di Moro RAL 8028	40,00	48,80	41,10	50,14	41,50	50,63
	100412 *		100429 *		100436 *	
SSM 3 Siva mišje RAL 7005	40,00	48,80	41,10	50,14	41,50	50,63
	100351 *		100368 *		100375 *	
ICM 4 Črna intenzivno RAL 9005	40,00	48,80	41,10	50,14	41,50	50,63
	119018 *		119049 *		119087 *	
OCM 5 Vinsko rdeča RAL 3009	40,00	48,80	41,10	50,14	41,50	50,63
	119025 *		119063 *		119094 *	
ZHM 6 Anodic RAL 7013	40,00	48,80	41,10	50,14	41,50	50,63
	112026 *		112033 *		112040 *	
BHM 7 Srebrna RAL 9006	40,00	48,80	41,10	50,14	41,50	50,63
	119032 *		119056 *		119070 *	
BM 8 Bela RAL 9010	40,00	48,80	41,10	50,14	41,50	50,63
	137258 *		157265 *		137272 *	
ZSM 9 Cink siva RAL extra	40,00	48,80	41,10	50,14	41,50	50,63
	137432 *		137449 *		137456 *	
MHM 10 Opečno rdeča RAL 8004	40,00	48,80	41,10	50,14	41,50	50,63
	137319 *		137326 *		137333 *	
MZM 11 Zelena mahovo RAL 6005	40,00	48,80	41,10	50,14	41,50	50,63
	137371 *		137388 *		137395 *	
BHTM 12 Temno srebrna RAL 9007	40,00	48,80	41,10	50,14	41,50	50,63
	137197 *		137203 *		137210 *	
Pakiranje v kos 	4		4		4	
Pakiranje v kos 	120		120		120	



* Izdelava po meri

ALUMINIUM W.15

MATT 3D EFFECT

REDUKCIJA CEVI 72°

W.15-WZO



Nominalna velikost	120/80		120/100		120/120	
	Brez DDV	Z DDV	Brez DDV	Z DDV	Brez DDV	Z DDV
ANM 1 Antracit RAL 7016	44,80	54,66	45,30	55,27	45,60	55,63
	094100 *		094117 *		094124 *	
TMM 2 Testa di Moro RAL 8028	44,80	54,66	45,30	55,27	45,60	55,63
	100443 *		100450 *		100467 *	
SSM 3 Siva mišje RAL 7005	44,80	54,66	45,30	55,27	45,60	55,63
	100382 *		100399 *		100405 *	
ICM 4 Črna intenzivno RAL 9005	44,80	54,66	45,30	55,27	45,60	55,63
	119117 *		119148 *		119179 *	
OCM 5 Vinsko rdeča RAL 3009	44,80	54,66	45,30	55,27	45,60	55,63
	119100 *		119155 *		119186 *	
ZHM 6 Anodic RAL 7013	44,80	54,66	45,30	55,27	45,60	55,63
	112057 *		112064 *		112071 *	
BHM 7 Srebrna RAL 9006	44,80	54,66	45,30	55,27	45,60	55,63
	119124 *		119131 *		119162 *	
BM 8 Bela RAL 9010	44,80	54,66	45,30	55,27	45,60	55,63
	137289 *		137296 *		137302 *	
ZSM 9 Cink siva RAL extra	44,80	54,66	45,30	55,27	45,60	55,63
	137463 *		137470 *		137487 *	
MHM 10 Opečno rdeča RAL 8004	44,80	54,66	45,30	55,27	45,60	55,63
	137340 *		137357 *		137364 *	
MZM 11 Zelena mahovo RAL 6005	44,80	54,66	45,30	55,27	45,60	55,63
	137401 *		137418 *		137425 *	
BHTM 12 Temno srebrna RAL 9007	44,80	54,66	45,30	55,27	45,60	55,63
	137227 *		137234 *		137241 *	
Pakiranje v kos 	3		3		3	
Pakiranje v kos 	90		90		90	

* Izdelava po meri



OBJEMKA Z NAVOJEM M10

W.15-WOB

Nominalna velikost	80		100		120	
	Brez DDV	Z DDV	Brez DDV	Z DDV	Brez DDV	Z DDV
ANM 1 Antracit RAL 7016	3,40	4,15	3,55	4,33	4,05	4,94
	093875		093882		093899	
TMM 2 Testa di Moro RAL 8028	3,40	4,15	3,55	4,33	4,05	4,94
	099761		099778		099785	
SSM 3 Siva mišje RAL 7005	3,40	4,15	3,55	4,33	4,05	4,94
	099730		099747		099754	
ICM 4 Črna intenzivno RAL 9005	3,40	4,15	3,55	4,33	4,05	4,94
	118530		118547		118554 *	
OCM 5 Vinsko rdeča RAL 3009	3,40	4,15	3,55	4,33	4,05	4,94
	118561 *		118578 *		118585 *	
ZHM 6 Anodic RAL 7013	3,40	4,15	3,55	4,33	4,05	4,94
	111845		111852		111869	
BHM 7 Srebna RAL 9006	3,40	4,15	3,55	4,33	4,05	4,94
	118509 *		118516 *		118523 *	
BM 8 Bela RAL 9010	3,40	4,15	3,55	4,33	4,05	4,94
	136572 *		136589		136596 *	
ZSM 9 Cink siva RAL extra	3,40	4,15	3,55	4,33	4,05	4,94
	136664 *		136671 *		136688 *	
MHM 10 Opečno rdeča RAL 8004	3,40	4,15	3,55	4,33	4,05	4,94
	136602		136619		136626	
MZM 11 Zelena mahovo RAL 6005	3,40	4,15	3,55	4,33	4,05	4,94
	136633 *		136640 *		136657 *	
BHTM 12 Temno srebna RAL 9007	3,40	4,15	3,55	4,33	4,05	4,94
	136541 *		136558 *		136565 *	
Pakiranje v kos 	10		10		10	
Pakiranje v kos 	1 200		1 200		1 200	

* Izdelava po meri





ALUMINIUM W.15

MATT 3D EFFECT

INOX VIJAK ZA OBJEMKO M8x30

P-POB-NSK





Nominalna velikost	EAN številko izdelka	Pakiranje v kos		Cena [€/kos]	
				Brez DDV	Z DDV
M8 x 30 *	139658	1	–	0,25	0,31

* Izdelava po meri

VIJAK ZA OBJEMKO TORX M10

P-POB-HT





Nominalna velikost	EAN številko izdelka	Pakiranje v kos		Cena [€/kos]	
				Brez DDV	Z DDV
80	002464	100	40 000	1,00	1,22
140	002471	100	28 000	1,25	1,53
200	002488	100	20 000	1,55	1,89
250	002495	100	16 000	1,70	2,07
300	002501	100	11 200	1,70	2,07

VLOŽEK M10

P-POB-HN DB





Nominalna velikost	EAN številko izdelka	Pakiranje v kos		Cena [€/kos]	
				Brez DDV	Z DDV
120	002426	100	25 000	0,40	0,49

VLOŽEK Z LAMELO M10

P-POB-HN DB





Nominalna velikost	EAN številko izdelka	Pakiranje v kos		Cena [€/kos]	
				Brez DDV	Z DDV
180	002433	100	12 000	0,42	0,51
240	002440	100	12 000	0,50	0,61
280	002457	100	12 000	0,53	0,65

KOMBINIRANI VIJAK TORX M10

P-POB-ZT/SZ





Nominalna velikost	EAN številko izdelka	Pakiranje v kos		Cena [€/kos]	
				Brez DDV	Z DDV
140	002587	50	10 400	0,45	0,55
180	002594	50	10 400	0,55	0,67

VLOŽEK ZA IZOLACIJO M10

P-POB-HN IZOL





Nominalna velikost	EAN številko izdelka	Pakiranje v kos		Cena [€/kos]	
				Brez DDV	Z DDV
M10 x 96	001207	25	2 625	2,70	3,29

IZOLACIJSKI ZATIČ KONICA ZIDAK BREZ TOPLLOTNE IZOLACIJE

P-POB-HN WDVS140 M10





Nominalna velikost	EAN številko izdelka	Pakiranje v kos		Cena [€/kos]	
				Brez DDV	Z DDV
140	144843	1/5	750	4,80	5,86

IZOLACIJSKI ZATIČ KONICA ZIDAK S TOPLLOTNO IZOLACIJO

P-POB-HN WDVS300 M10





Nominalna velikost	EAN številko izdelka	Pakiranje v kos		Cena [€/kos]	
				Brez DDV	Z DDV
300	144850	1/5	500	7,80	9,52

NERJAVNA UNI PLATFORMA ZA PRITRJEVANJE OB M10

P-POB-HN PLAT M10



Nominalna velikost	EAN številko izdelka	Pakiranje v kos		Cena [€/kos]	
				Brez DDV	Z DDV
M10	144836	25/500	5 000	3,35	4,09



ALUMINIUM W.15

MATT 3D EFFECT

NAVOJNA PALICA M10

P-POB-ZT





Nominalna velikost	EAN številko izdelka	Pakiranje v kos		Cena [€/kos]	
				Brez DDV	Z DDV
60	002556	100	20 800	0,20	0,24
100	002563	100	15 600	0,30	0,37
150	002570	50	10 400	0,55	0,67

PRITRILNA PLOŠČA M10

P-POB-ZT MP

















Nominalna velikost	EAN številko izdelka	Pakiranje v kos		Cena [€/kos]	
				Brez DDV	Z DDV
80 x 30	002518	25	5 200	1,15	1,40

ZAŠČITNI POKROV OBJEMKE

P-POB-HT AKG





Nominalna velikost	EAN številko izdelka	Pakiranje v kos		Cena [€/kos]	
				Brez DDV	Z DDV
 29 x 13	002280	50	16 800	0,25	0,31
 29 x 13	002211	50	16 800	0,25	0,31
 29 x 13	002235	50	16 800	0,25	0,31
 29 x 13	002266	50	16 800	0,25	0,31
 29 x 13	002242	50	16 800	0,25	0,31
  29 x 13	002228	50	16 800	0,25	0,31
   29 x 13	002273	50	16 800	0,25	0,31
 29 x 13	002259	50	16 800	0,25	0,31
 29 x 13	002297	50	16 800	0,25	0,31

LOVILEC VODE S SITOM

W.15-WZVS



Nominalna velikost	80		100		120	
	Brez DDV	Z DDV	Brez DDV	Z DDV	Brez DDV	Z DDV
ANM 1 Antracit RAL 7016	26,50	32,33	29,10	35,50	43,70	53,31
	094216		094223		094230	
TMM 2 Testa di Moro RAL 8028	26,50	32,33	29,10	35,50	43,70	53,31
	100320		100337		100344	
SSM 3 Siva mišje RAL 7005	26,50	32,33	29,10	35,50	43,70	53,31
	100290		100306		100313	
ICM 4 Črna intenzivno RAL 9005	26,50	32,33	29,10	35,50	43,70	53,31
	114419		114426		114433	
OCM 5 Vinsko rdeča RAL 3009	26,50	32,33	29,10	35,50	43,70	53,31
	114389 *		114402 *		114396 *	
ZHM 6 Anodic RAL 7013	26,50	32,33	29,10	35,50	43,70	53,31
	112156		112163		112170	
BHM 7 Srebrna RAL 9006	26,50	32,33	29,10	35,50	43,70	53,31
	114440		114457		114464	
BM 8 Bela RAL 9010	26,50	32,33	29,10	35,50	43,70	53,31
	124883 *		124890		124906 *	
ZSM 9 Cink siva RAL extra	26,50	32,33	29,10	35,50	43,70	53,31
	124975 *		124982 *		124999 *	
MHM 10 Opečno rdeča RAL 8004	26,50	32,33	29,10	35,50	43,70	53,31
	124913 *		124920 *		124937 *	
MZM 11 Zelena mahovo RAL 6005	26,50	32,33	29,10	35,50	43,70	53,31
	124944 *		124951 *		124968 *	
BHTM 12 Temno srebrna RAL 9007	26,50	32,33	29,10	35,50	43,70	53,31
	124852 *		124869 *		124876 *	
Pakiranje v kos 	2		3		3	
Pakiranje v kos 	240		90		90	

* Izdelava po meri

LOVILEC VODE S CEVJO

W.15-WZVHA



Dimenzija: 80, 120



Dimenzija: 100



Nominalna velikost	80		100		120	
	Brez DDV	Z DDV	Brez DDV	Z DDV	Brez DDV	Z DDV
ANM 1 Antracit RAL 7016	65,00	79,30	60,00	73,20	125,00	152,50
	094186 *		094193		094209 *	
TMM 2 Testa di Moro RAL 8028	65,00	79,30	60,00	73,20	125,00	152,50
	100269 *		100276 *		100283 *	
SSM 3 Siva mišje RAL 7005	65,00	79,30	60,00	73,20	125,00	152,50
	100238 *		100245 *		100252 *	
ICM 4 Črna intenzivno RAL 9005	65,00	79,30	60,00	73,20	125,00	152,50
	116116 *		116123 *		116130 *	
OCM 5 Vinsko rdeča RAL 3009	65,00	79,30	60,00	73,20	125,00	152,50
	116147 *		116154 *		116161 *	
ZHM 6 Anodic RAL 7013	65,00	79,30	60,00	73,20	125,00	152,50
	112132 *		112316 *		112149 *	
BHM 7 Srebrna RAL 9006	65,00	79,30	60,00	73,20	125,00	152,50
	116086 *		116093 *		116109 *	
BM 8 Bela RAL 9010	65,00	79,30	60,00	73,20	125,00	152,50
	137623 *		137630 *		137647 *	
ZSM 9 Cink siva RAL extra	65,00	79,30	60,00	73,20	125,00	152,50
	137715 *		137722 *		137739 *	
MHM 10 Opečno rdeča RAL 8004	65,00	79,30	60,00	73,20	125,00	152,50
	137654 *		137661 *		137678 *	
MZM 11 Zelena mahovo RAL 6005	65,00	79,30	60,00	73,20	125,00	152,50
	137685 *		137692 *		137708 *	
BHTM 12 Temno srebrna RAL 9007	65,00	79,30	60,00	73,20	125,00	152,50
	137593 *		137609 *		137616 *	
Pakiranje v kos	1		1		1	
Pakiranje v kos	60		60		60	

* Izdelava po meri

ALUMINIUM W.15

MATT 3D EFFECT

POCINKANO ZAŠČITNA CEV Z REVIZIJSKO ODPRTINO W.15-WOZR

Nominalna velikost	80		100		100	
	1,0		1,0		1,5	
Dolžina v m	1,0		1,0		1,5	
	1,0		1,0		1,5	
Cena v €/kos	Brez DDV	Z DDV	Brez DDV	Z DDV	Brez DDV	Z DDV
	ANM 1 Antracit RAL 7016	65,50	79,91	51,00	62,22	104,00
122742 *		122759 *		122766 *		
TMM 2 Testa di Moro RAL 8028	65,50	79,91	51,00	62,22	104,00	126,88
	123046 *		123053 *		123060 *	
SSM 3 Siva mišje RAL 7005	65,50	79,91	51,00	62,22	104,00	126,88
	122995 *		123008 *		123015 *	
ICM 4 Črna intenzivno RAL 9005	65,50	79,91	51,00	62,22	104,00	126,88
	122797 *		122803 *		122810 *	
OCM 5 Vinsko rdeča RAL 3009	65,50	79,91	51,00	62,22	104,00	126,88
	122841 *		122858 *		122865 *	
ZHM 6 Anodic RAL 7013	65,50	79,91	51,00	62,22	104,00	126,88
	122940 *		122957 *		122964 *	
BHM 7 Srebrna RAL 9006	65,50	79,91	51,00	62,22	104,00	126,88
	122896 *		122902 *		122919 *	
BM 8 Bela RAL 9010	65,50	79,91	51,00	62,22	104,00	126,88
	123190 *		123206 *		123213 *	
ZSM 9 Cink siva RAL extra	65,50	79,91	51,00	62,22	104,00	126,88
	123145 *		123152 *		123169 *	
MHM 10 Opečno rdeča RAL 8004	65,50	79,91	51,00	62,22	104,00	126,88
	123244 *		123251 *		123268 *	
MZM 11 Zelena mahovo RAL 6005	65,50	79,91	51,00	62,22	104,00	126,88
	123091 *		123107 *		123114 *	
BHTM 12 Temno srebrna RAL 9007	65,50	79,91	51,00	62,22	104,00	126,88
	123336 *		123305 *		123312 *	
Pakiranje v kos 	1		1		1	
Pakiranje v kos 	70		60		60	



* Izdelava po meri



ALUMINIUM W.15

MATT 3D EFFECT

POCINKANO ZAŠČITNA CEV Z REVIZIJSKO ODPRTINO W.15-WOZR



Nominalna velikost	120		120	
	Dolžina v m			
Cena v €/kos	1,0		1,5	
	Brez DDV	Z DDV	Brez DDV	Z DDV
ANM Antracit RAL 7016	114,40	139,57	163,30	199,23
	122773 *		122780 *	
TMM Testa di Moro RAL 8028	114,40	139,57	163,30	199,23
	123077 *		123084 *	
SSM Siva mišje RAL 7005	114,40	139,57	163,30	199,23
	123022 *		123039 *	
ICM Črna intenzivno RAL 9005	114,40	139,57	163,30	199,23
	122827 *		122834 *	
OCM Vinsko rdeča RAL 3009	114,40	139,57	163,30	199,23
	122872 *		122889 *	
ZHM Anodic RAL 7013	114,40	139,57	163,30	199,23
	122971 *		122988 *	
BHM Srebrna RAL 9006	114,40	139,57	163,30	199,23
	122926 *		122933 *	
BM Bela RAL 9010	114,40	139,57	163,30	199,23
	123220 *		123237 *	
ZSM Cink siva RAL extra	114,40	139,57	163,30	199,23
	123176 *		123183 *	
MHM Opečno rdeča RAL 8004	114,40	139,57	163,30	199,23
	123275 *		123282 *	
MZM Zelena mahovo RAL 6005	114,40	139,57	163,30	199,23
	123121 *		123138 *	
BHTM Temno srebrna RAL 9007	114,40	139,57	163,30	199,23
	123329 *		123299 *	
Pakiranje v kos 	1		1	
Pakiranje v kos 	40		40	

* Izdelava po meri

POCINKANO OBJEMKA Z GUMO M10

P-POB-OZR



Nominalna velikost	EAN številko izdelka	Pakiranje v kos		Cena [€/kos]	
				Brez DDV	Z DDV
80	002525	25	1 250	1,55	1,89
100	002532	25	1 250	2,00	2,44
120	002549	20	1 000	2,25	2,75

ALUMINIUM W.15

MATT 3D EFFECT

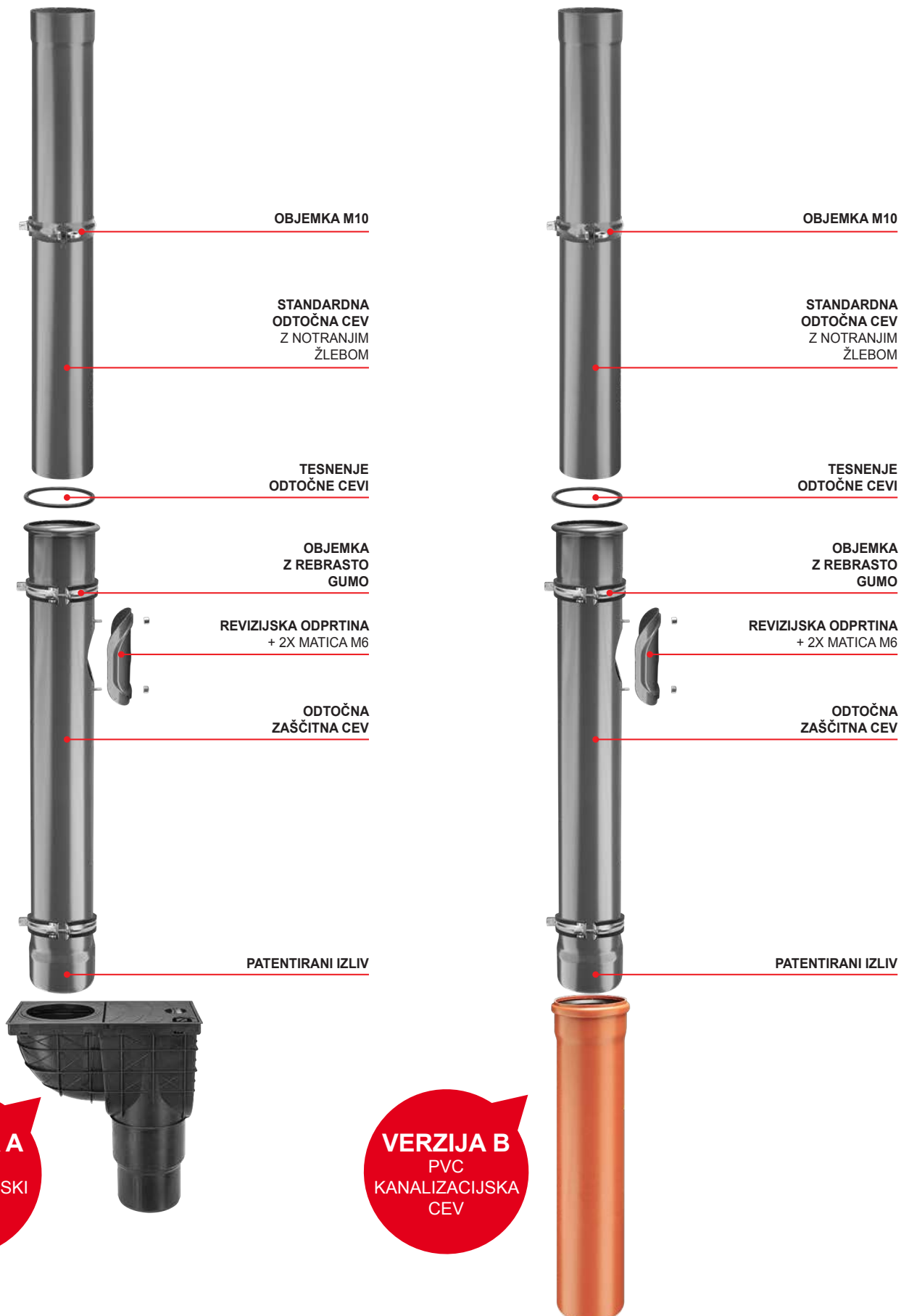

VERZIJA A
PVC
KANALIZACIJSKI
ODTOK

VERZIJA B
PVC
KANALIZACIJSKA
CEV

I. OSNOVNA DOLOČILA

- Družba KJG a.s., s sedežem Malinovského 800/131, 916 21 Čachtice, MŠ: 31 439 951 (v nadaljevanju „prodajalec“), izdaja naslednje splošne poslovne pogoje za prodajo in dobavo žlebnega strešnega sistema in opreme, lahke strešne kritine, trapezov, metalurškega materiala, strešnih dodatkov, orodij, strojev in drugega blaga v povezavi s strešnim sistemom (v nadaljevanju „blago“), ki jo prodajalec izvaja na podlagi okvirne kupne pogodbe (v nadaljevanju „OKP“) v odnosu do podjetnika pri izvajanju njegove poslovne dejavnosti in do države, državne ustanove, upravne enote ali javne institucije za zagotavljanje javnih potreb ali lastnega obratovanja (v nadaljevanju „kupec“).
- Splošni poslovni pogoji so kot del OKP sestavni del vsake posamezne kupoprodajne pogodbe (v nadaljevanju tudi „pogodba“), ki jo sklene prodajalec in kupec na podlagi OKP.

II. SKLENITEV KUPNE POGODBE

- Pisno naročilo kupca pomeni predlog za sklenitev posamezne kupoprodajne pogodbe, pri čemer mora vsako naročilo kupca vsebovati:
 - identifikacijske podatke kupca, ki so potrebni za izdajo računa;
 - opredelitev naročenega blaga (zlasti tip, vrsto, količino in mere);
 - kraj dobave, dobavni rok in način dobave blaga;
 - datum naročila;
 - ime, priimek, funkcija in podpis osebe, ki lahko zastopa kupca.
- Posamezna kupoprodajna pogodba je sklenjena v trenutku, ko prodajalec pisno potrdi naročilo kupca.

III. KUPNINA IN PLAČILNI POGOJI

- Kupec se zavezuje, da bo prodajalcu redno in pravočasno plačal kupnino za naročeno blago. Kupnina je določena po ceniku prodajalca (cene blaga so brez DDV), ki je veljaven na dan naročila kupca. Kupnino bo prodajalec v potrdilu naročila navedel po veljavnih pravnih predpisih vključno z DDV (pri dobavi blaga v Slovenski republiki). V nujnih primerih, kadar se kupnina določi kot samostojna cenovna kalkulacija na podlagi veljavnega cenika, kupec plača kupnino po cenovni kalkulaciji, ki jo prodajalec določi kot končni znesek kupnine glede na stroške, a ne sme biti višja od kupnine, ki je bila določena s kalkulacijo. Kupec ima pravico do popusta na ceno blaga v skladu z OKP. Če prodajalec spremeni v času trajanja OKP višino popusta za kupca pri ceni blaga, nemudoma kupca o tem dejstvu obvesti. Pri dobavi blaga v Slovenski republiki zaračuna prodajalec kupcu tudi DDV po veljavnih pravnih predpisih.
- Kupec ima za naročila blaga določen finančni kreditni limit in zapadlost računov v smislu OKP, prodajalec pa lahko fakturira kupnino kupcu z dnem dobave oziroma odpreme blaga. Po porabi kredita v smislu OKP ali v primeru neplačanega računa s strani kupca v roku zapadlosti, prodajalec lahko prekine dobavo blaga kupcu na podlagi pogodbe in ne potrdi drugega pisnega naročila kupca. S prekinjenimi dobavami blaga prodajalec nadaljuje:
 - v primeru prekoračitve kreditnega limita: s plačilom najstarejših računov do zneska preseženega kreditnega limita in plačilu vrednosti zahtevane odpreme blaga;
 - v primeru neplačanega zapadlega računa: po plačilu računa v celotni višini. Prodajalec lahko kadarkoli v času veljavnosti OKP spremeni kreditni limit kupca.
- Plačilo šteje za pravočasno v primeru priliva na račun prodajalca ali gotovinskega plačila v blagajni prodajalca do roka zapadlosti.
- Če kupec ne plača računa v roku zapadlosti, prodajalec lahko obračuna zamudne obresti v višini 0,05 % neplačanega zneska za vsak dan zamude.

IV. DOBAVA BLAGA IN PRIDRŽEK LASTNINE

- Prodajalec mora dobaviti blago kupcu v pogodbeno dogovorjeni količini, kakovosti in izvedbi, ki je primerna za namembno uporabo blaga. Dobavljeno blago prodajalca mora kupec prevzeti.
- Če se pogodbeni stranki nista dogovorili drugače, prodajalec mora blago zapakirati ali opremiti za prevoz na način, ki je običajen za zadevno blago v poslovnem stiku.
- Dobava blaga se izvede v roku in na način, ki sta ga pogodbeni strani dogovorili s pogodbo.
- Pri dobavi blaga prodajalcu mora zaposleni pri kupcu izkazati pravico do prevzema blaga.
- Če se blago izroča na sedežu prodajalca (oziroma v pripadajočem skladišču prodajalca, ki mu kupec predloži naročilnico) brez nakladanja na prevozno sredstvo, mora prevoznik, ki ga določi kupec, izkazati pravico do prevzema blaga.
- Če se blago dobavi kupcu na kraj dobave, ki je naveden v naročilu, z vozilom prodajalca, zaračuna prodajalec kupcu stroške prevoza po ceniku prevoza, ki je veljaven na dan predložitve naročila s strani kupca. Prodajalec si pridržuje pravico do razkladanja blaga samo v dostopnem terenu po njegovi presoji.
- Če ni določeno drugače, zaračuna prodajalec poštno stroške za pošiljanje blaga kupcu.
- Kupec se zavezuje, da bo v dobavnem roku blago prevzel. Če kupec obveznosti glede prevzema blaga v dobavnem roku ne izpolni, prodajalec ga pozove za izpolnitev obveznosti v dodatnem primernem roku. Če kupec blaga ne prevzame niti v dodatnem primernem roku, prodajalec lahko od pogodbe odstopi.
- Kupec, ki do dneva dobave blaga ne plača celotne kupnine, pridobi pravico do dobavljenega blaga šele s plačilom celotnega zneska kupnine.

V. PREHOD NEVARNOSTI ZA NASTANEK ŠKODE

- Nevarnost nastanka škode na blagu preide na kupca v trenutku prevzema blaga od prodajalca oziroma njegovega prevoznika; če kupec blaga ne prevzame pravočasno, preide nevarnost za nastanek škode na kupca v trenutku, ko prodajalec ali njegov prevoznik omogoči razpolaganje z blagom in kupec blaga ni prevzel ter je kršil pogodbo, čeprav je za možnost prevzema blaga vedel.
- Če prodajalec izroči blago za prevoz prevozniku, ki ga je določil kupec, na svojem sedežu v kraju Čachtice (oziroma v pripadajočem skladišču prodajalca), od katerega bo kupec blago prevzel, preide nevarnost za nastanek škode na kupca v trenutku izročitve blaga prevozniku.
- Če mora prodajalec odposlati blago kupcu, preide nevarnost za nastanek škode na blagu na kupca v trenutku izročitve blaga prvemu prevozniku za prevoz do namembnega kraja.
- Kupec mora pregledati blago takoj po prehodu nevarnosti za nastanek škode na blagu. Če se blago pošilja kupcu, mora blago pregledati takoj po dobavi v namembni kraj.

VI. ODGOVORNOST ZA NAPAKE IN GARANCIJA

- Prodajalec je odgovoren za napake blaga v trenutku prehoda nevarnosti za nastanek škode na kupca, četudi postane napaka očitna šele kasneje. Prodajalec je odgovoren tudi za vsako napako, ki nastane po prehodu nevarnosti nastanka škode na kupca, če škoda nastane zaradi kršitve njegovih obveznosti.
- Če kupec ne pregleda ali ne zagotovi pregleda blaga v času prehoda nevarnosti za nastanek škode na blagu, lahko uveljavi pravice za napake, ki bi jih lahko ugotovil ob takšnem pregledu, če izkaže obstoj takšne napake na blagu že v času prehoda nevarnosti za nastanek škode na blagu.
- Kupec mora prodajalcu sporočiti napake blaga takoj, ko
 - a/ bo ugotovil napako;
 - b/ bi moral ob strokovni skrbi napako ugotoviti ob pregledu, ki ga mora opraviti ob prehodu nevarnosti za nastanek škode ali
 - c/ bo napako ugotovil pozneje, najpozneje pa v dveh letih od časa dobave blaga oziroma dostave blaga na namembni kraj, ki je določen v pogodbi. Pri napakah, na katere se nanaša garancija za kakovost, velja namesto tega roka garancijski rok.
- Če prodajalec nudi kupcu garancijo za kakovost blaga, navede takšno izjavo v samostojnem garancijskem listu, v katerem navede tudi reklamacijski postopek.
- Garancijski rok prične teči z dnem dobave blaga. Če blago odpošilja prodajalec, garancijski rok teče od dneva dostave blaga na namembni kraj. Garancijski rok ne teče v času, kadar kupec ne more blaga uporabljati zaradi napak, za katere je odgovoren prodajalec.
- V primeru dobave blaga z napako kupcu je izključena uporaba določil 436. in 437. člena, drugega, tretjega in četrtega odstavka 439. člena in 441. člena Trgovinskega zakonika, prodajalec v takšnem primeru nudi kupcu popust ali odstrani napake, ki jih kupec navaja:
 - a/ z dobavo manjkajočega blaga;
 - b/ s popravilom blaga ali dobavo nadomestnega blaga v primeru odstranljivih napakah ali
 - c/ dobavo nadomestnega blaga v primeru napak, ki jih ni mogoče odstraniti.
- Popust mora ustrezati razliki med vrednostjo, ki bi jo imelo blago brez napak, in vrednostjo, ki jo ima dobavljeno blago z napako, pri čemer je za določitev vrednosti odločilen čas, ko bi morala biti izvedena redna dobava. Kupec, ki mu prodajalec nudi popust pri kupnini, ne more zahtevati nadomestila izgubljenega dohodka zaradi pomanjkljivih karakteristik blaga, na katerega se popust nanaša.
- Pri dobavi nadomestnega blaga lahko prodajalec zahteva, da mu kupec na njegove stroške vrne blago, ki je predmet zamenjave, in sicer v stanju, v kakršnem je bilo dobavljeno. To ne velja, če nezmožnost vračila blaga v tako navedenem stanju ni nastala z ravnanjem ali opustitvijo dolžnega ravnanja kupca, ali je sprememba stanja nastala zaradi rednega pregleda za namen ugotovitve napak blaga. Če pred odkritjem napak kupec blago ali del blaga proda ali blago v celoti ali delno porabi ali spremeni ob njegovi običajni uporabi, mora neprodano ali neuporabljeno ali spremenjeno blago vrniti in zagotoviti prodajalcu nadomestilo do višine, v kateri je imel iz navedene uporabe blaga korist.
- Odgovornost prodajalca za napake, na katere se ne nanaša garancija za kakovost, ne nastane, če so te napake nastale po prehodu nevarnosti za nastanek škode na blagu z zunanjimi dogodki in jih ni povzročil prodajalec ali osebe, s pomočjo katerih je izpolnjeval svojo obveznost.

VII. VIŠJA SILA

- Če po sklenitvi pogodbe nastanejo nepredvidene in nespremenljive okoliščine, ki pomenijo trajno ali začasno oviro za izpolnjevanje obveznosti pogodbenih strani iz sklenjene pogodbe (vis maior), neizpolnitev obveznosti (ob trajni oviri) pogodbenih strani oziroma pozna izpolnitev obveznosti (ob začasni oviri) ne pomeni kršitve te pogodbe, pogodbeni stranki pa ni odgovorna za morebitno škodo, ki bi lahko nastala v povezavi z neizpolnitvijo pogodbenih obveznosti. Če je ovira za izpolnjevanje obveznosti iz pogodbe samo začasna, pogodbeni stranki se zavezuje, da bosta pristopili k izpolnjevanju svojih obveznosti nemudoma po odpravi takšne ovire. Vsaka pogodbeni stranki mora nemudoma obvestiti drugo pogodbeno stran o nastanku zgoraj navedenih ovir.
- Kot vis maior štejejo zlasti naravne nesreče, samovoljno ravnanje tretjih oseb, stavke, delovne izločitve, blokade, vojne (napovedane in nenapovedane), spremenjena politična situacija, ki izključuje ali nesorazmerno otežuje izvajanje pravic in obveznosti iz pogodbe ali drugi podobni dogodki.

VIII. VARSTVO OSEBNIH PODATKOV

- Kupec (za namene tega člena tudi druga oseba, ki je podpisana v OKP in naročilu v imenu kupca) daje prodajalcu izrecno soglasje v smislu zakona št. 428/2002 Ur. l. o varstvu osebnih podatkov po veljavnem besedilu (v nadaljevanju samo »zakon«) z obdelavo osebnih podatkov, ki so navedeni v OKP in naročilu kupca.
 - 8.2. Kupec daje prodajalcu izrecno soglasje z obdelavo osebnih podatkov za namen:
 - a/ izvajanja pravic in obveznosti iz OKP in posamezne pogodbe;
 - b/ vodenja evidence, ki jo mora prodajalec voditi v skladu z zakonom ali na podlagi zakona;
 - c/ trženja.
 - 8.3. Kupec izrecno soglaša, da prodajalec lahko za namene iz alineje 8.2. posreduje njegove osebne podatke tretji osebi, ki jo je pooblastil za izvajanje zadevne dejavnosti.
 - 8.4. Kupec soglaša, da prodajalec obdeluje njegove osebne podatke:
 - a/ za čas, ko mora prodajalec voditi evidenco iz alineje 8.2. točka b);
 - b/ za nujno potreben čas za zaščito zakonskih pravic in pravno zagotovljenih interesov prodajalca.
 - 8.5. Kupec jemlje na znanje, da lahko svoje soglasje z obdelavo osebnih podatkov prekliche in zahteva uničenje svojih osebnih podatkov v primeru, da prodajalec oziroma tretje osebe, ki jim je prodajalec posredoval osebne podatke, kršijo zakonske obveznosti.

IX. KONČNA DOLOČILA

- Kupec ne more na tretjo osebo prenesti ali tretji osebi odstopiti pravic iz OKP ali posamezne pogodbe brez izrecnega soglasja prodajalca.
- Če ni s splošnimi poslovnimi pogoji določeno drugače, OKP se lahko spremeni samo s pisnimi aneksi, ki jih podpisajo predstavniki obeh pogodbenih strani.
- Drugečni dogovori iz posamezne pogodbe med prodajalcem in kupcem imajo prednost pred določili OKP in temi splošnimi poslovnimi pogoji. Pravna razmerja, ki niso urejena z OKP, posamezno pogodbo in splošnimi poslovnimi pogoji, se ravnajo po Trgovinskem zakoniku in drugih splošno zavezujočih pravnih predpisih Slovenske republike, pri čemer so izključena kolizijska pravila in uporaba Konvencije Združenih narodov o pogodbah o mednarodni prodaji blaga (CISG) z dne 11.04.1980 in njihovih morebitnih dodatkov v primeru, da ima kupec sedež (kraj poslovanja) v drugi državi ali se blago dobavlja v drugo državo.
- Vse spore, ki nastanejo na podlagi OKP, bodo pogodbeni strani reševale po mirni poti. Reševanje sporov, ki jih ne bo mogoče rešiti sporazumno, je v pristojnosti (izključno) pristojnega sodišča Slovenske republike.
- Te splošne pogoje izdaja prodajalec po 273. členu Trgovinskega zakonika, in sicer z veljavnostjo od 01.01.2017