



GUTTER SYSTEM SEMI CIRCULAR – CIRCULAR



PRICE LIST 2024

RECOMMENDED CONSUMER PRICES



POWERFUL PARTNER FOR YOUR ROOF



Stainless steel material | 3

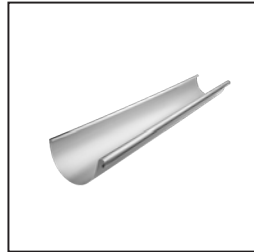

Gutter | 6

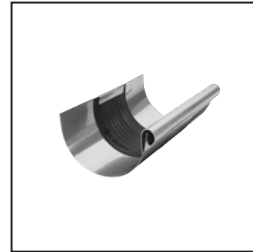

Gutter expanders | 6



Gutter accessories | 8



Gutter hook | 9



Corner | 10



End Cap | 10



Outlet | 11



Elbow | 13



Downpipe | 14

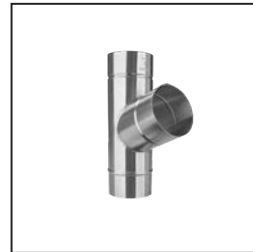

Downpipe accessories | 14



Pipe bracket | 14

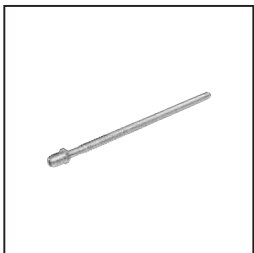

Pipe bracket accessories | 15



Downpipe flap | 18



Protective gutter pipe | 19

GUTTER SYSTEM SEMI CIRCULAR – CIRCULAR

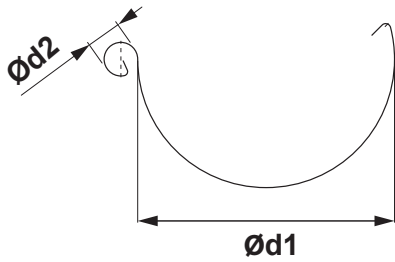

ROOF GUTTER DIMENSIONS

(dimensions and dimensional tolerances according to EN 612)

Developed width (mm)	250	280	333
Ød1	105	127	153
Ød2	18	18	20

WELDED TIG

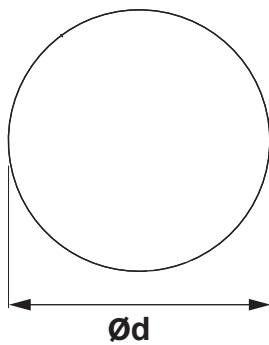

SPOUT PIPE DIMENSIONS

(dimensions and dimensional tolerances according to EN 612)

Nominal dimension	60	80	100	120
Nominal size Ød (mm)	60	80	100	120

GUTTER BRACKET DIMENSIONS

(dimensions and dimensional tolerances according to EN 612)

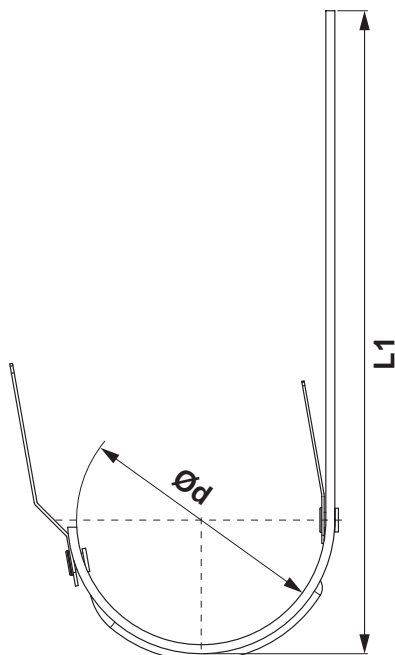

Dimensions (mm)	L1	Ød
250	310	105
280	345	127
333 – 550	385	153

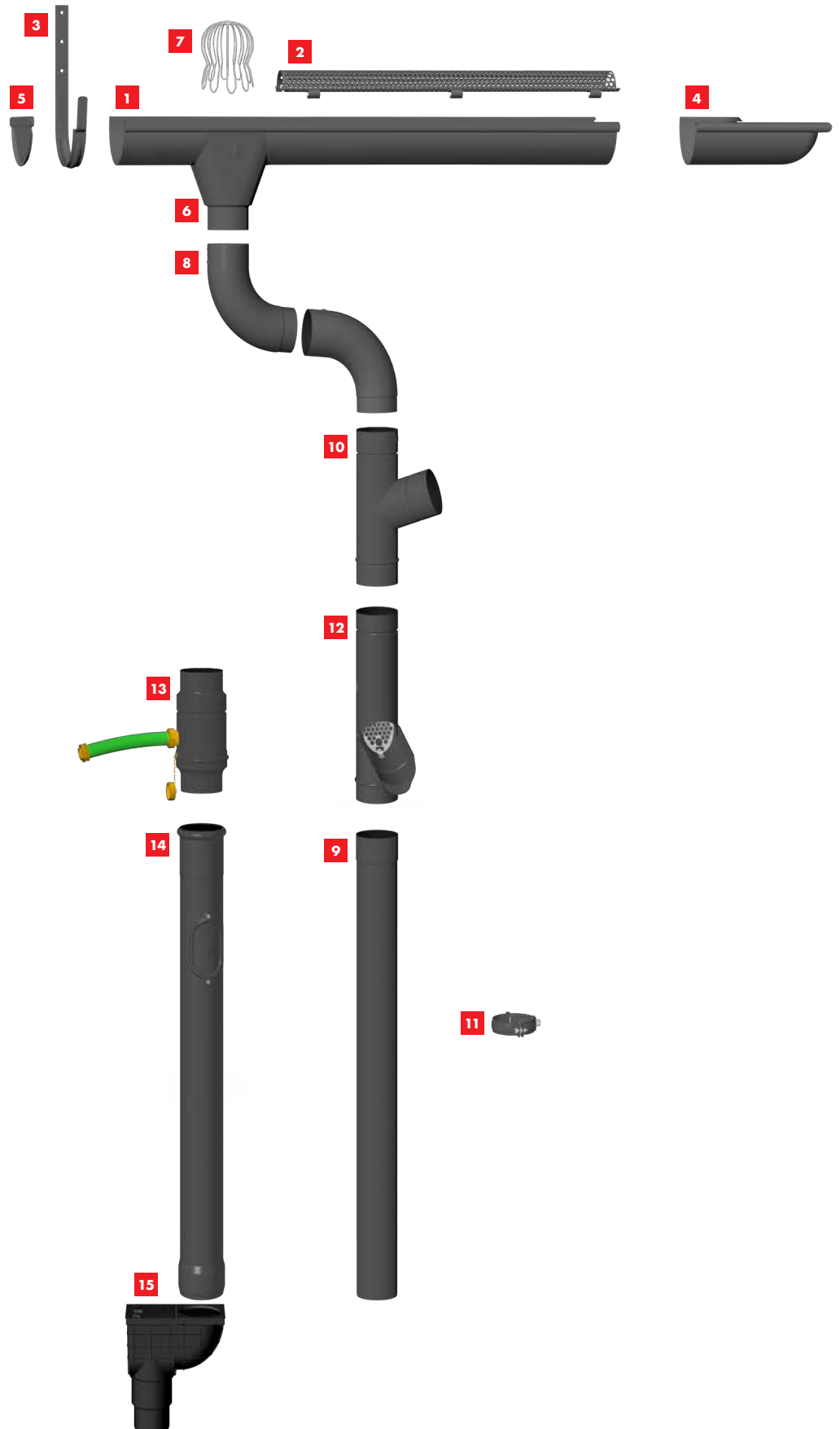

- 1** Gutter half-round
- 2** Gutter leaf guard
- 3** Gutter hook
- 4** Corner outer
- 5** End Cap
- 6** Outlet
- 7** Leaf sieve
- 8** Elbow
- 9** Downpipe
- 10** Downpipe branch
- 11** Pipe bracket with thread M10
- 12** Downpipe flap with sieve
- 13** Water collector+hose
- 14** Protec.gutter pipe col.
- 15** Rain drum, straight outlet





STAINLESS STEEL

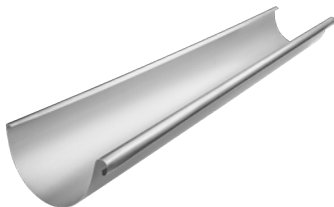

GUTTER HALF-ROUND [s=0,50 mm]

N-NZ





Nominal dimension	Lenght in m	EAN product number	Packaging in m		Price with VAT [€/m]
					
250	4,0	086679	20	960	10,50
280	4,0	086686	20	840	11,76
333	4,0	086693	20	660	11,94
333	6,0	086709	30	990	11,94

GUTTER ON-ROOF [s=0,50 mm]

N-NZS





Nominal dimension	Lenght in m	EAN product number	Packaging in m		Price with VAT [€/m]
					
650 *	4,0	102850	4	200	32,40

* Custom production

GUTTER EXPANDERS

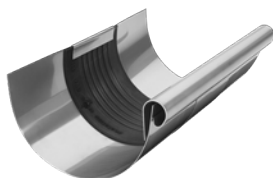
N-NZDI





Nominal dimension	EAN product number	Packaging in pcs		Price with VAT [€/pcs]
				
250/260	092205	3	360	17,34
285/260	092212	3	360	18,60
333/260	092229	5	200	20,52

ON-ROOF GUTTER EXPANSION COMPONENT

N-NZSDI





Nominal dimension	EAN product number	Packaging in pcs		Price with VAT [€/pcs]
				
670/260	110671	1	40	47,88

ENDLESS TAPES

N-NZDIP



Nominal dimension	Lenght in m	EAN product number	Packaging in m		Price with VAT [€/m]
					
260	3,0	102805	3	120	57,00

USE OF DILATATION GUTTER AND DILATATION STRIP

DILATATION GUTTER

Installation example: Hanging gutter with a developed width of up to 500 mm. The dilatation gutter shall be installed at spacing of 15 m. For outer corner and beginning of the gutter, a half of the standard value is applied: maximum 7,5 m. For inner corner, a quarter of the standard value is applied: maximum 3,75 m. For other materials and dimensions: see the table below. Corners are always taken into account as fixed points.

ROOF SEMICIRCULAR DILATATION GUTTERS

Developed gutter width	Aluminium	Steel, Titanium-zinc, Copper, Stainless steel
< 500	12	15
> 500	8	10

DILATATION STRIP

Indoor installation: on gutters attached without gluing to a substrate, roofs with non-standard profile and roof cladding

ROOF DILATATION STRIP

Developed gutter width	Aluminium	Steel, Titanium-zinc, Copper, Stainless steel
< 500	8	10
> 500	6	8

For outer corner or the beginning of the gutter, a half of the standard value shall be applied.

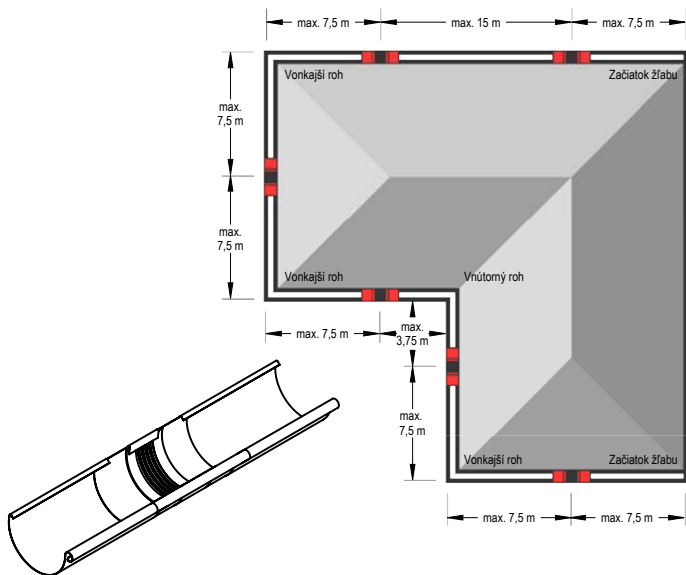

Note to the dilatation gutter mounting.

When mounting by soldering, first cover the middle rubber part with a wet cloth (to prevent heat transfer to the middle rubber part). A minimum distance of 6 cm from the middle rubber part must be kept. In any case avoid contact of rubber with open flame.

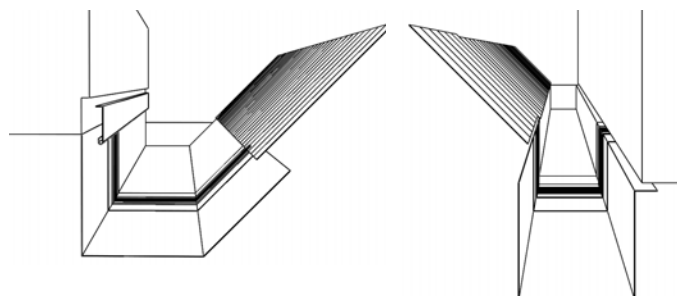

Note to the dilatation strip mounting.

When bending and mounting dilatation elements, make sure that:

- Bending jaws have a radius of at least 2 mm.
- For sheet metal thicknesses over 1 mm, it must be observed bending radius at least 5 mm.
- When bending, the bending jaws should be set to a thickness of the middle rubber part of 3 to 4 mm to prevent the cutting effect - damage to the rubber.
- The rubber middle part must not be compressed or damaged during bending. Therefore, an aluminium sheet strip 2 to 5 mm (thick) should be used, bent so that it can be attached as a protection to the bending jaws. This achieves a larger bending radius and prevents the rubber middle part from breaking.



ALUMINIUM GUTTER LEAF GUARD

W-WZNLM

Nominal dimension	Dĺžka v m	EAN product number	Packaging in pcs		Price with VAT [€/pcs]
333	2,0	064905	25	300	30,60

PVC GUTTER GUARD

SD-ZNL MRIEZKA

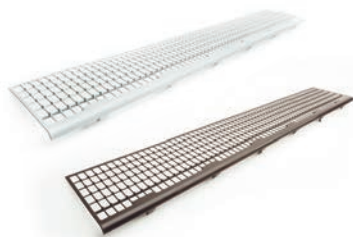

Nominal dimension	Lenght in m	EAN product number	Packaging in pcs		Price with VAT [€/pcs]
171	1,0	008473	30	450	5,40
171	1,0	008466	30	450	5,40

PVC GUTTER GUARD

SD-ZNL N

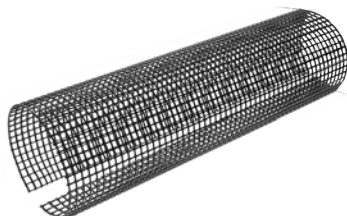



Nominal dimension	Lenght in m	EAN product number	Packaging in pcs		Price with VAT [€/pcs]
250	3,0	008480	10	400	28,68
280-333	3,0	008497	10	400	28,80



GUTTER HOOK

N-NHP





Nominal dimension	Material	EAN product number	Packaging in pcs		Price with VAT [€/pcs]
					
250/430	25/4	092274	10	1 000	5,16
280/480	25/4	092281	10	1 000	6,00
333/550	30/4	092298	10	1 000	6,84

TITANIUM ZINC ON-ROOF GUTTER HOOK WITH SUPPORT

TZ-TZHOBSN



Nominal dimension	Material	EAN product number	Packaging in pcs		Price with VAT [€/pcs]
					
4	25/6	000910	15	300	20,76

CORNER OUTER

N-NRCA

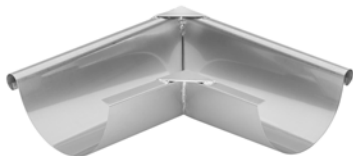

Nominal dimension	EAN product number	Packaging in pcs		Price with VAT [€/pcs]
250	092380 MAFA	2	150	51,60
280	092397 MAFA	2	150	52,68
333	092403 MAFA	2	150	54,00

MAFA – Manufactory (handmade)

CORNER INNER

N-NRCI

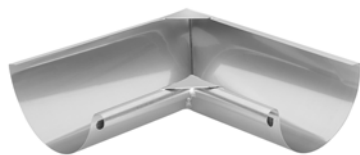

Nominal dimension	EAN product number	Packaging in pcs		Price with VAT [€/pcs]
250	092434 MAFA	2	150	51,60
280	092441 MAFA	2	150	52,68
333	092458 MAFA	2	150	54,00

MAFA – Manufactory (handmade)

END CAP

N-NCL



Nominal dimension	EAN product number	Packaging in pcs		Price with VAT [€/pcs]
250	092175	6/60	1 440	1,62
280	092182	6/60	1 440	1,86
333	092199	6/60	1 440	2,16

STAINLESS STEEL

OUTLET

N-NKL



Nominal dimension	EAN product number	Packaging in pcs		Price with VAT [€/pcs]
250/80	092311	20	600	28,08
280/100	092328	20	600	30,48
333/100	092335	20	600	30,96
333/120	092342	15	300	59,40

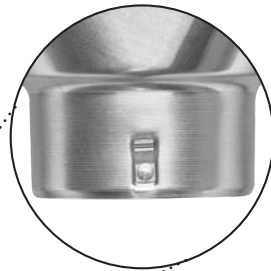

NEW CLAMPING SYSTEM FEDER ENABLES TO TURN THE ELBOW EASY IN THE DESIRED DIRECTION AND HOLDS RELIABLY IN ANY POSITION. EASY INSTALLATION TO ANY ELBOW WITHOUT RIVETING.



LEAF SIEVE

N-NZN



Nominal dimension	EAN product number	Packaging in pcs		Price with VAT [€/pcs]
				
60	001153	30	2 160	6,66
80	001160	20	1 440	6,72
100	001177	15	1 080	6,84
120	001184	10	720	7,44
150	001191	5	360	11,76

STAINLESS STEEL



ELBOW 72°

N-NK



Nominal dimension	EAN product number	Packaging in pcs		Price with VAT [€/pcs]
60	086600	25	11,04	10,68
80	086617	25	10,80	10,20
100	086631	25	12,24	11,94
120	086655	15	19,20	17,40

ELBOW RADIUS 85°

N-NKR



Nominal dimension	EAN product number	Packaging in pcs		Price with VAT [€/pcs]
80	086624	25	400	12,00
100	086648	25	300	13,80
120	086662	15	240	19,44

ELBOW BLIND 40°

N-NKT





Nominal dimension	EAN product number	Packaging in pcs		Price with VAT [€/pcs]
80	092359	25	400	11,04
100	092366	25	300	13,14
120	092373	15	240	19,20

STAINLESS STEEL



DOWNPIPE [s=0,50 mm]



N-NZR

Nominal dimension	Lenght in m	EAN product number	Packaging in m		Price with VAT [€/m]
					
60	2,0	081322	10	490	8,22
80	3,0	081339	15	270	10,68
100	3,0	081346	15	180	11,94
100	4,0	081353	20	240	11,94
120	3,0	081360	24	144	15,84
120	4,0	081377	32	192	15,84



PLASTIC DOWNPIPE SLEEVE



SD-ZR FOLIA KJG

Nominal dimension	Lenght in m	EAN product number	Packaging in m		Price with VAT [€/m]
					
60-150	100,0	139726	100	6 000	0,46

DOWNPIPE BRANCH 72°

N-NZO





Nominal dimension	EAN product number	Packaging in pcs		Price with VAT [€/pcs]
				
80/80 *	092489	4	90	24,00
100/60 *	092496	4	120	24,84
100/80 *	092502	4	120	25,80
100/100	092519	4	120	26,40
120/100	092526	3	90	29,52
120/120 *	092533	3	90	30,00

* Custom production

PIPE BRACKET WITH THREAD M10

N-NOB





Nominal dimension	EAN product number	Packaging in pcs		Price with VAT [€/pcs]
				
60	054869	25	3 000	4,80
80	054876	25	3 000	4,80
100	054883	25	3 000	4,98
120	054890	25	3 000	5,40



SCREW FOR DOWNPIPE BRACKET M8x30

P-POB-NSK



Nominal dimension	EAN product number	Packaging in pcs		Price with VAT [€/pcs]
				
M8 x 30 *	139658	1	–	0,30

* Custom production



SCREW FOR DOWNPIPE BRACKET WITH THREADED TORX M10

P-POB-HT



Nominal dimension	EAN product number	Packaging in pcs		Price with VAT [€/pcs]
				
80	002464	100	40 000	1,20
140	002471	100	28 000	1,50
200	002488	100	20 000	1,86
250	002495	100	16 000	2,04
300	002501	100	11 200	2,04

STAINLESS STEEL



DOWEL M10



P-POB-HN DB

Nominal dimension	EAN product number	Packaging in pcs		Price with VAT [€/pcs]
				
120	002426	100	25 000	0,48



DOWEL WITH LAMELLA M10



P-POB-HN DB

Nominal dimension	EAN product number	Packaging in pcs		Price with VAT [€/pcs]
				
180	002433	100	12 000	0,50
240	002440	100	12 000	0,60
280	002457	100	12 000	0,64



COMBISCREW TORX M10

P-POB-ZT/SZ

Nominal dimension	EAN product number	Packaging in pcs		Price with VAT [€/pcs]
				
140	002587	50	10 400	0,54
180	002594	50	10 400	0,66



INSULATION DOWEL M10

P-POB-HN IZOL

Nominal dimension	EAN product number	Packaging in pcs		Price with VAT [€/pcs]
M10 x 96	001207	25	2 625	3,24



INSULATING DOWEL TIP OF THE BRICK WITHOUT INSULATION P-POB-HN WDVS140 M10

Nominal dimension	EAN product number	Packaging in pcs		Price with VAT [€/pcs]
140	144843	1/5	750	5,76

STAINLESS STEEL



INSULATING DOWEL TIP OF THE BRICK WITH INSULATION P-POB-HN WDVS300 M10

Nominal dimension	EAN product number	Packaging in pcs		Price with VAT [€/pcs]
300	144850	1/5	500	9,36

STAINLESS STEEL UNI PLATFORM TO ATTACH OB M10 P-POB-HN PLAT M10



Nominal dimension	EAN product number	Packaging in pcs		Price with VAT [€/pcs]
M10	144836	25/500	5 000	4,02

THREADED ROD M10

P-POB-ZT



Nominal dimension	EAN product number	Packaging in pcs		Price with VAT [€/pcs]
60	002556	100	20 800	0,24
100	002563	100	15 600	0,36
150	002570	50	10 400	0,66

DOWNPIPE BRACKET MOUNTING PLATE M10

P-POB-ZT MP



Nominal dimension	EAN product number	Packaging in pcs		Price with VAT [€/pcs]
80 x 30	002518	25	5 200	1,38

RUBBER CAP FOR DOWNPIPE BRACKET SCREW

P-POB-HT AKG



Nominal dimension	EAN product number	Packaging in pcs		Price with VAT [€/pcs]
29 x 13	002280	50	16 800	0,30
29 x 13	002211	50	16 800	0,30
29 x 13	002235	50	16 800	0,30
29 x 13	002266	50	16 800	0,30
29 x 13	002242	50	16 800	0,30
29 x 13	002228	50	16 800	0,30
29 x 13	002273	50	16 800	0,30
29 x 13	002259	50	16 800	0,30
29 x 13	002297	50	16 800	0,30



DOWNPIPE FLAP WITH SIEVE

N-NZVS



Nominal dimension	EAN product number	Packaging in pcs		Price with VAT [€/pcs]
80	035165	6	180	IN THE TESTING PROCESS
100	035172	5	240	IN THE TESTING PROCESS
120	035189	3	150	IN THE TESTING PROCESS

ALUMINIUM WATER COLLECTOR+HOSE

W-WZVHA



Dimension: 80, 120

Dimension: 100

Nominal dimension	EAN product number	Packaging in pcs		Price with VAT [€/pcs]
80	001481	1	60	70,20
100	001498	1	60	64,80
120	001504	1	60	135,00



GALVANIZED STEEL PROTEC.GUTTER PIPE COL.

P-POZR

Nominal dimension	Lenght in m	EAN product number	Packaging in pcs		Price with VAT [€/pcs]
80	1,0	009708	1	70	72,00
100	1,0	009715	1	60	54,00
100	1,5	009722	1	60	106,80



GALVANIZED STEEL PROTEC.GUTTER PIPE COL.

P-POZR

Nominal dimension	Lenght in m	EAN product number	Packaging in pcs		Price with VAT [€/pcs]
120	1,0	009739	1	40	126,00
120	1,5	009746	1	40	171,60

STAINLESS STEEL



PIPE CLAMP WITH GASKET M10

P-POB-OZR

Nominal dimension	EAN product number	Packaging in pcs		Price with VAT [€/pcs]
80	002525	25	1 250	1,86
100	002532	25	1 250	2,40
120	002549	20	1 000	2,70

STAINLESS STEEL

STAINLESS
STEEL

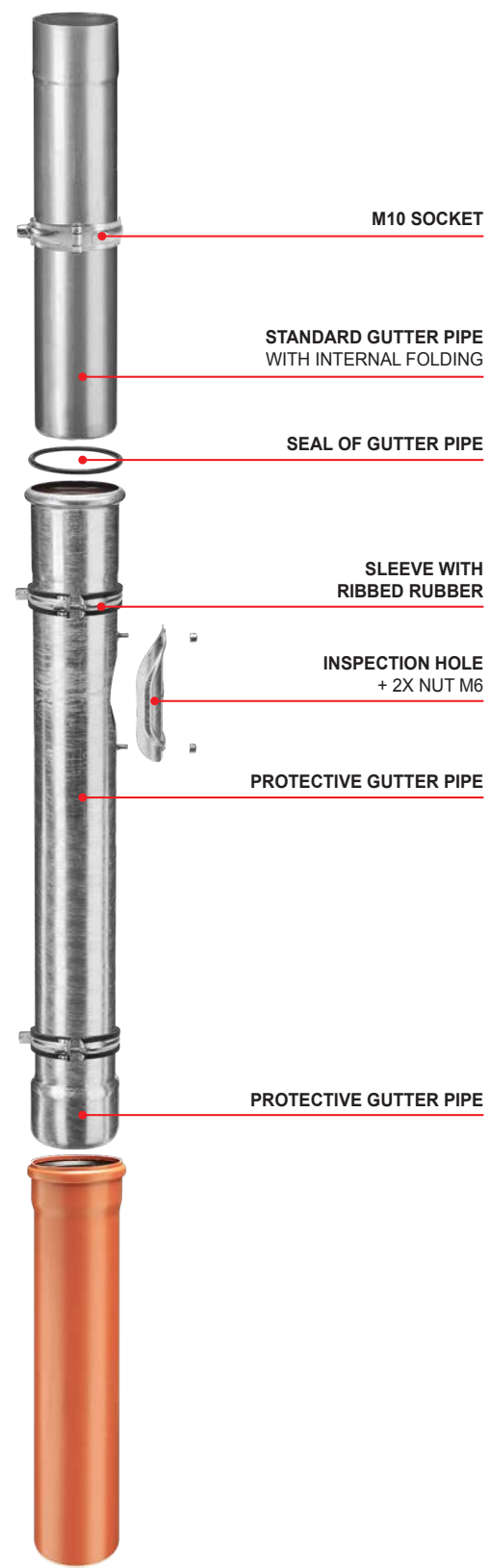
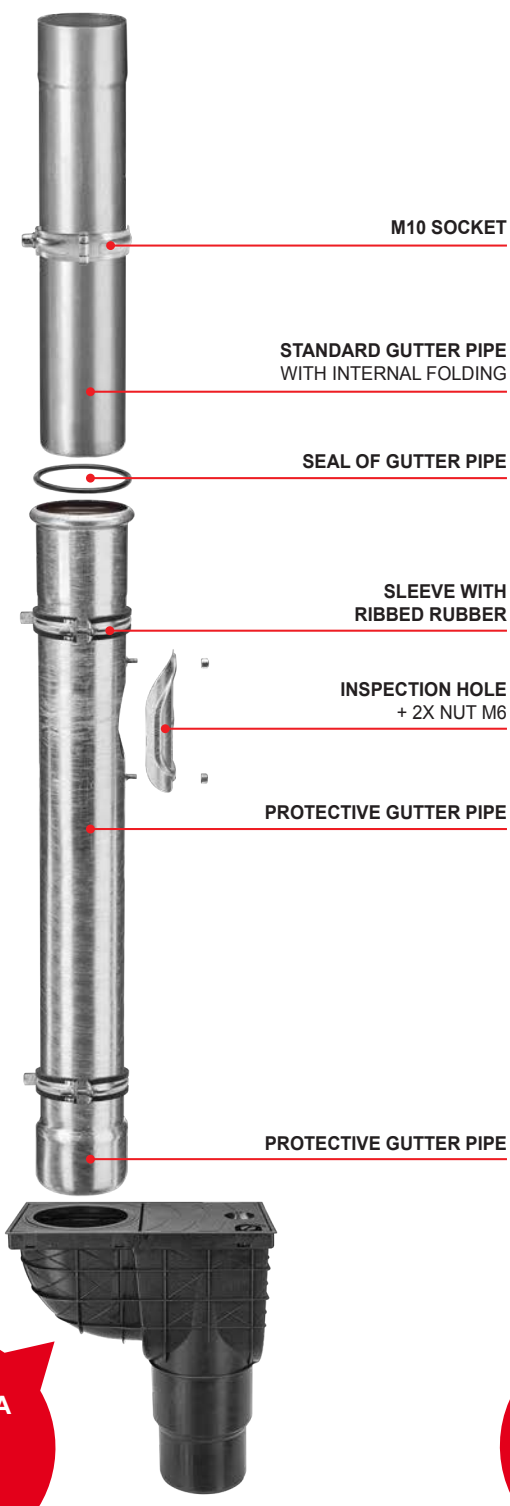

I. BASIC PROVISIONS

- 1.1. The company KJG a.s., with its registered office at Malinovského 800/131, 916 21 Čachtice, Company ID: 31 439 951 (hereinafter referred to as the „Seller“), issues the following General business terms and conditions that apply to the sale and supply of gutter roof system with accessories, light roofing, trapezoids, metallurgical materials, roofing accessories, tools, machinery and commercial goods related to the roof system (hereinafter referred to as the „goods“) performed by the Seller on the basis of a framework purchase contract (referred to as „FPC“) in relation to an entrepreneur in carrying out its business activities and to the state, state organization, self-governing territorial unit or to a legal entity established by law as a public institution in the provision of public needs or its own operation (hereinafter referred to as the „Buyer“).
- 1.2. These General terms and conditions as an integrated part of FPC are an integral part of each individual purchase contract (hereinafter also „IPC“ or „contract“) concluded between the Seller and the Buyer on the basis of FPC.

II. CONCLUSION OF PURCHASE CONTRACT

- 2.1. The Buyer's written order is considered to be a proposal to conclude an IPC, whereby each Buyer's order should contain:
 - identification data of the Buyer necessary for issuing the invoice,
 - specification of the ordered goods (especially type, kind, quantity and dimensions),
 - delivery place, delivery time and method of delivery of goods,
 - date of issue of the order,
 - name, surname, position and signature of the person authorized to act on behalf of the Buyer.
- 2.3. The IPC is considered closed at the moment of written confirmation of the Buyer's order by the Seller.

III. PURCHASE PRICE AND PAYMENT TERMS

- 3.1. The Buyer undertakes to pay the Seller the purchase price for the ordered goods properly and in due time. The purchase price is determined according to the Seller's price list (prices of goods are to be understood without VAT) valid on the day of submitting the order by the Buyer and its amount will be stated by the Seller in the Buyer's order confirmation including VAT (when delivering goods in Slovakia) according to valid legal regulations. In necessary cases, if the purchase price is determined on the basis of individual price calculation based on the valid price list, the Buyer shall be obliged to pay the purchase price up to the amount determined by price calculation on condition that the Seller shall determine the final purchase price according to costs incurred, but this shall not exceed the purchase price determined by calculation. The buyer is entitled to a discount on the price of the goods in the amount resulting from the FPC; if the Seller changes the amount of the Buyer's discount on the price of the goods during the FPC period, it shall immediately inform the Buyer in writing. When delivering the goods in the Slovak Republic, the Seller charges the Buyer, in addition to the price of the goods, VAT in accordance with the valid legal regulations.
- 3.2. The Buyer shall have a set financial credit limit for the purchase of goods and the maturity of invoices in accordance with the FPC, while the Seller shall be entitled to invoice the purchase price to the Buyer on the day of delivery or shipping the goods to the Buyer, respectively. After overdrawing the credit limit specified in the FPC or in the case of non-payment of the invoice by the Buyer within the due date, the Seller is entitled to interrupt the delivery of goods to the Buyer on the basis of the contract and not to confirm another written order of the Buyer. The Seller shall continue with further deliveries of goods:
 - in the case of exceeded credit limit - after payment of the oldest invoices up to the amount of exceeding the credit limit and simultaneous payment of the value of the required purchase of goods,
 - in the case of non-payment of the invoice within the due date - after its full payment. The Seller shall be entitled to change the credit limit set for the Buyer at any time throughout the duration of the FPC.
- 3.3. Payment shall be deemed to have been made in time if it has been credited to the Seller's account or paid in cash at the Seller's cash desk by the due date.
- 3.4. If the Buyer does not pay the invoice within the due date, the Seller shall be entitled to charge the Buyer for interest on late payment in the amount of 0.05 % of the unpaid amount for each day of delay.

IV. DELIVERY OF GOODS AND RETENTION OF TITLE

- 4.1. The Seller shall be obliged to deliver the goods to the Buyer in the quantity agreed in the contract and in a quality and design that is suitable for the purpose for which the goods are used. The Buyer is obliged to take over the goods delivered by the Seller.
- 4.2. Unless the contracting parties have agreed otherwise, the Seller is obliged to pack or arrange the goods for transport in the manner that is usual for such goods in business.
- 4.3. Delivery of the goods shall take place within the period and in the manner agreed by the contracting parties in the contract.
- 4.4. Upon delivery of the goods by the Seller, the Buyer's employee shall be obliged to prove the right to take over the goods.
- 4.5. If the goods are to be made available not loaded on a means of transport at the Seller's registered office (or the relevant warehouse of the Seller, to which the Buyer has submitted an order) by the Buyer to the designated carrier, the latter is obliged to prove the right to take over the goods.
- 4.6. In the event that the goods are to be delivered to the Buyer to the delivery point specified in the order using a Seller's vehicle, the Seller will charge the Buyer for transport costs according to the transport price list valid on the day of submitting the order by the Buyer. At the same time, the Seller reserves the right to unload the goods only in an available terrain at its sole discretion.
- 4.7. In the case of goods to be sent to the Buyer, the Seller shall charge the Buyer for postage, unless agreed otherwise.
- 4.8. The Buyer undertakes to withdraw the goods within the delivery period. If the Buyer fails to fulfil its obligation to take over the goods within the delivery period, the Seller shall invite the Buyer to fulfil the Seller's obligation within an additional reasonable period. Failure to take over the goods by the Buyer nor within an additional reasonable period gives rise to the Seller's right to withdraw from the contract.
- 4.9. The buyer who does not pay the whole amount of the purchase price until the delivery of the goods will acquire ownership of the delivered goods only after full payment of the purchase price.

V. PASSING OF RISK OF DAMAGE TO GOODS

- 5.1. The risk of damage to the goods passes to the Buyer at the moment the Buyer takes over the goods from the Seller, or by the carrier designated by him, or if the Buyer fails to do so in time, at the time when the Seller or the Seller's designated carrier allows the Buyer to dispose of the goods, while the Buyer is being aware of this possibility and breaches the contract by not taking over the goods.
- 5.2. If the Seller is to hand over the goods for transport by the carrier designated by the Buyer at its registered office in Čachtice (or the relevant warehouse of the Seller) from which the Buyer is to take over the goods, the risk of damage to the goods passes to the Buyer upon handing over the goods to this carrier.
- 5.3. In the event that the Seller is to send the goods to the Buyer, the risk of damage to the goods passes to the Buyer at the time of delivery of the goods to the first carrier for transport to the destination.
- 5.4. The buyer is obliged to inspect the goods without undue delay after the risk of damage to the goods has passed. If the goods are sent to the Buyer, the Buyer is obliged to inspect the goods without undue delay after their delivery to the destination. The company KJG a.s. reserves the right to change prices, packaging and printing.

VI. LIABILITY FOR DEFECTS AND WARRANTY

- 6.1. The Seller shall be responsible for the defect by which the goods have been affected at the moment when the risk of damage to the goods passes to the Buyer, even if the defect becomes apparent only after this time. The Seller is also responsible for any defect arising after the risk of damage to the goods has passed to the Buyer if caused by a breach of the Buyer's duties.
- 6.2. If the Buyer does not inspect the goods or does not arrange to inspect them at the time of passing the risk of damage to the goods, the Buyer may claim for defects detectable during this inspection only if the Buyer proves that the goods were already affected by these defects at the time of passing the risk of damage to the goods.
- 6.3. The Buyer shall be obliged to notify the Seller of defects in the goods without undue delay after:
 - a) The Buyer found the defects,
 - b) The Buyer, while exercising professional care, should have found defects during the inspection, which the Buyer is obliged to carry out after the risk of damage to the goods has passed, or
 - c) The defects could be found later with the exercise of professional care, but no later than within two years from the time of delivery of the goods, or from the arrival of the goods to the destination specified in the contract. For defects covered by the quality warranty, instead of this period of time the warranty period applies.
- 6.4. If the Seller provides the Buyer with a warranty for the quality of the delivered goods, it shall do so by making a statement in a separate warranty card, which will also state the procedure for complaints.
- 6.5. The warranty period begins to run from the date of delivery of the goods. If the Seller is obliged to send the goods, the warranty period runs from the day the goods arrive at its destination. The warranty period does not run for a period during which the Buyer cannot use the goods due to their defects, which is the Seller's responsibility.
- 6.6. In the case of delivery of goods to the Buyer with defects, the use of prov. § 436, § 437, § 439 par. 2, 3, 4 and § 441 of the Commercial Code are explicitly excluded and the Seller in such a case shall provide the Buyer with a discount on the purchase price or shall remove the defects in the goods complained by the Buyer:
 - a) by delivery of missing goods,
 - b) by repair of goods or delivery of replacement goods in case of remediable defects
 - c) by delivery of replacement goods in the event of irreparable defects.
- 6.7. The discount granted by the Seller on the purchase price shall correspond to the difference between the value of the goods without defects and the value of the goods delivered with defects, while the decisive time for determining the values is the time at which proper fulfillment should have taken place. The Buyer, to whom the Seller has been granted a discount on the purchase price, is not entitled to claim compensation for the loss of profit due to the lack of properties of the goods to which the discount applies.
- 6.8. Upon delivery of replacement goods, the Seller shall be entitled to demand the exchanged goods to be returned to the Seller at the Buyer's expense in the condition in which they were delivered to the Buyer. This does not apply if the impossibility of returning the goods in the condition specified therein is not caused by the actions or omissions of the Buyer, or if the change in the condition of the goods occurred as a result of an inspection duly performed to detect defects in the goods. In the event that before the detection of defects the Buyer sold the goods or part thereof or consumed the goods in whole or in part or altered them in their normal use, the Buyer shall be obliged to return unsold or unconsumed goods or altered goods and provide the Seller with compensation to the extent to which the Seller has benefited from that use of the goods.
- 6.9. The Seller's responsibility for defects not covered by the quality warranty does not arise if these defects were caused after the passing of the risk of damage to the goods by external events and were not caused by the Seller or the persons who helped to fulfil the Seller's obligation.

VII. VIS MAJOR

- 7.1. If, after the conclusion of the contract, unforeseeable and uncontrollable circumstances arise which create a permanent or temporary obstacle to the fulfillment of the obligations of the contracting parties of the concluded contract (refer to vis major), the non-fulfillment of obligations (in case of permanent obstacle) by a contracting party, or a delayed fulfillment of obligations (in case of temporary obstacle), shall not be considered a breach of this contract and the contracting party shall not be responsible for any damages that arise in connection with non-fulfillment of contractual obligations. If the obstacle incurred is only temporary for the fulfillment of obligations under the contract, the contracting parties undertake to start fulfilling their contractual obligations immediately after this obstacle disappears. Each contracting party shall be obliged to inform immediately the other contracting party of the occurrence of the above obstacles.
- 7.2. The followings are mainly considered to be vis major: natural events, arbitrary acts of third parties, strikes, work lockouts, blockades, wars (declared or undeclared), a change in the political situation or any other similar event which precludes or unduly impedes the exercise of rights and obligations under the contract.

VIII. PRIVACY POLICY

- 8.1. The Buyer (for the purposes of this article also another person signed on the FPC and the order on behalf of the Buyer) expressly grants to the Seller, according to Act no. 428/2002 Coll. on personal data protection as amended (hereinafter referred to as the „Act“), consent to the processing of its personal data specified in the FPC and the Buyer's order.
- 8.2. The Buyer expressly authorizes the Seller to process personal data for the purposes of:
 - a) exercise of the rights and obligations arising from the FPC and IPC,
 - b) keeping records, the obligation of which arises for the Seller by law or on the basis of the Act,
 - c) performing marketing activities.
- 8.3. The Buyer expressly gives the Seller consent to provide the Buyer's personal data for the purposes stated in point 8.2 to a third party which has been entrusted by the Buyer with the activity in question.
- 8.4. The Buyer expressly grants the Seller consent to the processing of personal data:
 - a) for the period in which the Seller is obliged to keep the records referred to in point 8.2. b /,
 - c) for the period in which it is necessary to protect the legal rights and legally protected interests of the Seller.
- 8.5. The Buyer takes into account that it has the right to revoke its consent to the processing of personal data and require the liquidation of its personal data in the event that the Seller, or a third party to whom the Seller has provided personal data, respectively, breaches the obligations arising from the Act.

IX. FINAL PROVISIONS

- 9.1. The Buyer is not entitled to transfer or assign the rights resulting for the Buyer from the FPC or IPC to a third party without the express consent of the Seller.
- 9.2. The FPC may be amended, unless otherwise provided in these General Terms and Conditions, only in the form of written amendments signed by representatives of both the contracting parties.
- 9.3. The agreed deviating provisions in the IPC between the Seller and the Buyer take precedence over the provisions of the FPC and these General Terms and Conditions. Legal relations that are not regulated in the FPC, IPC or in these General Terms and Conditions are governed by the Commercial Code and other generally binding legal regulations in force in the Slovak Republic, excluding the use of conflicting rules of law and the application of the UN Convention on Contracts for the International Sale of Goods /CISG/ of April 11, 1980 and their possible amendments in the case the Buyer has its registered office (place of business) in another state or the goods are delivered to another state.
- 9.4. All disputes arising from the implementation of the content of the FPC will be resolved by the contracting parties through an amicable settlement. Disputes that cannot be resolved by mutual agreement are entitled to be resolved (exclusively) by the competent court in the Slovak Republic.
- 9.5. These General Terms and Conditions are issued by the Seller pursuant to § 273 of the Commercial Code, with effect from January 1, 2017.